

BIHĀR PEASANT LIFE,

BEING

A DISCURSIVE CATALOGUE

OF THE

SURROUNDINGS OF THE PEOPLE OF THAT PROVINCE,

WITH MANY ILLUSTRATIONS FROM PHOTOGRAPHS TAKEN
BY THE AUTHOR.

Prepared, under Orders of the Government of Bengal,

BY

GEORGE A. GRIERSON, B.C.S., M.A.S.B., M.R.A.S.,

FELLOW OF THE UNIVERSITY OF CALCUTTA: FORMERLY HONORARY MEMBER AND HINDUSTANI
DEMONSTRATOR, TRINITY COLLEGE, DUBLIN.

Calcutta:

THE BENGAL SECRETARIAT PRESS.

LONDON: TRÜBNER & Co., 57 & 59, LUDGATE

TO

Sir Augustus Ribers Thompson,

K.C.S.I., C.I.E.

IN GRATEFUL ACKNOWLEDGMENT

OF THAT COUNTENANCE AND ASSISTANCE WITHOUT WHICH IT WOULD

NEVER HAVE BEEN WRITTEN,

THIS BOOK

IS DEDICATED

BY

THE AUTHOR.

INTRODUCTION.

WHILE this work professes to be a catalogue of the names used by the Bihar peasant for the things surrounding him in his daily life, yet, in order to relieve the dryness which such a mere list would possess, the writer has attempted to give a description, more or less complete, of that life and of its character and incidents. The book is in fact a discursive catalogue, and it is hoped that it may serve as a solid foundation for more elaborate disquisitions on the Bihār *raiyat* and his surroundings.

Such a work as this is nothing if not accurate, and no ordinary pains have been spared to compass the greatest accuracy possible. Existing treatises on Indian rural life are not always trustworthy; and as it is impossible to tell what is and what is not correct in them, the writer has avoided taking them as the groundwork of his compilation. Every word in this book has been collected from the mouths of the people, and noted on the spot where it was spoken, either by the writer himself or by one of his assistants. When the work began to assume shape, it was carefully compared with every available book of reference, and where discrepancies occurred, they were either reconciled or explained. Finally the proof-sheets have been circulated to all the Bihār districts, and have been again checked on the spot by competent observers, different from the original persons who collected the materials on which the book was founded.*

So far, therefore, as its contents go, this book may claim to be entirely original, and the writer hopes, to a certain degree, accurate. No originality can, however, be claimed for its general system and arrangement. This is closely modelled on Mr. Crooke's "Materials for a Rural and Agricultural Glossary of the North-Western Provinces

* The writer would here tender his thanks to the various district officers of Bihar, who have spared no trouble in having this local checking performed in a satisfactory manner. The amount of new information gained, and of mistakes and misprints corrected through their help has been very considerable.

and Oudh."* The writer has followed him very closely in the arrangement of his matter, and in many cases has not scrupled to use his very words when they were the most suitable that could be adopted. The vernacular words embodied in this book have in fact been brought together from two sources, viz. the writer's own private researches during the past seven years, checked and supplemented by actual translations of the words given by Mr. Crooke's work made by the writer's assistants once and sometimes twice over in every district of Bihār. It will thus be seen how much the writer is indebted to the latter gentleman. Mr. Crooke's book differed from the present work in being to some extent a compilation from existing dictionaries; and as these were not all of them as accurate as could be wished, it was impossible that it should not contain some mistakes. But as one who has probably worked through it with more minute attention than most people, the writer gladly bears witness to its general accuracy. This may be considered as really wonderful, when the extremely slovenly scholarship of some of the books on which Mr. Crooke had to depend is taken into account.

In the present work every native word is written twice over—once with accuracy in the native character for those who are able to read it, and once in the English character for those who are not acquainted with the Indian vernaculars. This transliteration does not pretend to be scientifically accurate. Such a transliteration with its diacritical dots and dashes would only puzzle those for whom it is intended, viz. those who are ignorant of the language. All that has been attempted for them is to give them a general idea of the correct pronunciation of the words, without professing to tell them the exact pronunciation, which they hardly require, and which would be difficult to do. For these persons all that is necessary is that they should pronounce the vowels as in Italian, and the consonants as in English, and they will then approach sufficiently near to the way in which the natives themselves pronounce the words.† For those who are acquainted with the

* Allahabad, 1879. Printed at the North-Western Provinces and Oudh Government Press. The writer would take this opportunity of acknowledging his indebtedness to Mr. Crooke for this really admirable work. Without it the present book could never have been written without an expenditure of labour which few district officials like the writer would have been able to bestow.

† The system of transliteration adopted may be briefly described as the Jonesian system, with every possible diacritical mark omitted. In pursuance of this the cerebral letters are given no dots, and, as nearly every final vowel is long, the long mark has been omitted from final vowels.

vernacular languages, no instructions for pronouncing the words in their vernacular dress are necessary.

In quoting Arabic and Persian words in the Nāgri character, the dots, which are sometimes used to indicate an original *s*, &c., are omitted, for the reason that the words are given as they are pronounced in Bihār, and that all the dots in the world will not make a Bihāri pronounce a *s* as other than *j*, or a *sād* as other than *s*.

In order to understand the meaning of the words which the writer has used to express locality, it is necessary to explain that, under the name Tirhut, he has included the whole tract which lies between the river Gandak on the west and the river Kosi on the east, and which is bounded on the north by the Nepal frontier and on the south by the Ganges. He, therefore, indicates under this term not only the districts of Muzaffarpur and Darbhanga, but also North Bhagalpur and North Munger (Monghyr). This was rendered necessary by the language of these latter tracts being practically the same as that of Darbhanga. By North-West Tirhut he means the Sitāmarhi and Sadr subdivisions of Muzaffarpur; by South-West Tirhut, the subdivision of Hajipur; by North-East Tirhut, the Sadr and Madhubani subdivisions of Darbhanga and the Supaul subdivision of North Bhagalpur; and by South-East Tirhut, the Tajpur subdivision of Darbhanga, North Munger, and the Madaipūra subdivision of North Bhagalpur. By North Bihār he means all Bihār north of the Ganges, and by South Bihār all Bihār south of it. When he speaks of the east or the west, the north-east or the north-west, he means, of course, the east, west, north-east, and north-west respectively of Bihār.

One more word of warning regarding these localities. When the writer says that a word is used in a certain place, he does not mean by implication that it is not used anywhere else. He means simply that the word has been noted by him in such and such a place, and not elsewhere. That it may be used elsewhere is very possible, and any notes on this or kindred topics addressed to the writer, care of the Secretary to the Bengal Government, Revenue and General Departments,* will be gladly welcomed.

Regarding the illustrations, they are all (with one or two small exceptions) lithographed or cut on wood from photographs taken by

* The writer would also suggest, as an excellent field for the discussion of the various points noted in this book, a magazine called *Panjāb Notes and Queries*, edited by Captain Temple, Cantonment Magistrate, Amritsar. Although published in and taking its title from the Panjāb, this useful little work deals with the whole of Northern

the writer, who is glad to be able to thank Mr. Schaumburg and the students of the Government School of Art, Calcutta, for the excellent pictures they have produced out of what, he must confess, were too often very indifferent photographs. The difficulties experienced by the writer in taking some of these pictures were great. The most ludicrous reports spread through the city concerning his work. The camera of course was looked upon as a fearful engine of destruction, and sometimes half an hour has been wasted in futile diplomacy to persuade an old lady to allow the lens to be pointed at her. Under these circumstances photographs had almost always to be taken by the instantaneous process, which, however certain it may be in the hands of the professional, frequently disappoints the mere amateur. The last photograph the writer took—that of a native house—was spoilt because the grandmother of the family refused to allow any of the children to appear in the picture, her reason being that the Government was building the bridge across the Gandak and wanted children to bury under its foundations. Just, however, as the plate was exposed, one of the little boys determined to immortalize himself, and leaped in front of the lens to the dismay of the female members of his family. He had his wish in appearing in the picture, but he was so near the lens that he covered half of it with his shoulders. On other occasions the writer was believed to be collecting carts and boats for the Egyptian war. or to be counting the wells in the country, because he knew a famine was approaching, and so on *ad infinitum*. However, the pictures were finally taken, and, such as they are, are certainly accurate representations of the originals.

In conclusion the writer has to draw attention to the thoroughness and accuracy with which his assistants Munshi Dilawar Ali and Munshi Moti Lal have done their portion of the work. The former has, the writer much regrets to say, died since the above was first written. The latter has been his assistant to the last, and the writer begs to record his high sense of his industry and intelligence, and to recommend his services to the favourable notice of Government.

ADDENDA ET CORRIGENDA.

A GOOD many types have broken in the process of printing. Advantage is taken of this list of errata to add information obtained after the sheets went to press.

These *addenda* and *corrigenda* are printed on one side of the paper only, and can be cut up and pasted in the appropriate places in the book.

Page.	Line.	Section.	For	Read.
3	5	समधर ...	समधर.
5	27	फहोडा, फहोरा ...	फहोडा, फहोरा.
10	16	डकीया ...	डकीया.
13	69	फरुधा ...	फरुधा.
17	4	खाना ...	खाना.
21	4	चानक ...	चानक.
22	113	बागडोर <i>bāgdor</i> ...	बाग डोर <i>bāg dor.</i>
23	7 from bottom.	बख्तखाना ...	बख्तखाना.
24	3	बैतखी ...	बैतखी.
25	Last line of footnote.	देखे ...	देखे.
26	137	बपखी ...	बपखी.
27	2	बदोह ...	बदोह.
34	2	बूँदिकारी ...	बूँदिकारी.
42	280	पडेकी ...	पडेकी.
44	298	बूते, बूतेखनियाँ ...	बूते, बूतेखनियाँ.
52	5	हेंकडा ...	हेंकडा.
58	317	बबुतरा ...	बबुतरा.
68	5	upper screw ...	upper roller.
68	Title of illustration.	UPPER ROLLER	UPPER ROLLER

Page.	Line.	Section.	For	Read.
78	15	बकगवा	बकगवा.
85	404	बकगवा	बकगवा.
87	17	बकगवा	बकगवा.
"	29	गरीब	गरीब.
95	1	तमाकुवावा	तमाकुवावा.
"	2	तमाकुवावा	तमाकुवावा.
"	Last	<i>dornsa</i>	<i>dorassa</i> .
96	18	<i>nariyal</i>	<i>nariyal</i> .
97	Last	बकगवा	बकगवा.
102	510	बकगवा	बकगवा.
109	516	बकगवा	बकगवा.
105	538	बकगवा <i>chakar sūn</i>	बकगवा <i>chakarsū</i> .
108	558	<i>thatherar</i>	<i>thathera</i> .
109	567	बकगवा, बकगवा	बकगवा, बकगवा.
110	570	बकगवा	बकगवा.
111	572	बकगवा	बकगवा.
"	"	<i>kumhain</i>	<i>kumhain</i> .
"	575	बकगवा	बकगवा.
112	584	बकगवा	बकगवा.
113	14	बकगवा	बकगवा.
114	586	बकगवा	बकगवा.
117	1	बकगवा <i>kolsūp</i>	बकगवा <i>kolsup</i> .
128	660	बकगवा <i>birhara</i>	बकगवा <i>birahra</i> .
134	713	बकगवा	बकगवा.
141	715	बकगवा	बकगवा.
145	732	बकगवा <i>jama</i>	बकगवा <i>jāma</i> .
152	759	बकगवा, बकगवा	बकगवा, बकगवा.
153	7	बकगवा	बकगवा.
154	766	<i>sari</i>	<i>sāri</i> .

Line.	Section.	For	Read.
3 from bottom.	बिहारी	बिहारी.
.....	771	किँकिनि, हुहर, हुँहर ...	किँकिनी, हुहह, हुँहह.
2 from bottom.	उख	उख.
.....	784a	<i>Add—</i> 'A homestead is also called डौंदा <i>diāra</i> or डौंदो <i>diāro</i> in South Bhagalpur.'	
.....	786	<i>After</i> 'goriatta,' <i>add—</i> 'or in South Bhagalpur गोरख' <i>goranti</i> .'	
12	<i>For</i> 'तरि' <i>read</i> 'तरी.'	
.....	794	<i>Add—</i> 'Soil mixed with coarse gravel is also कंकरोटिया <i>kankrotiya</i> , and hard rocky soil पथरौड़ी <i>pathrauti</i> in South Bhagalpur.'	
.....	797	<i>Before</i> 'बिहार्कट,' <i>insert</i> 'कुराव <i>kurāo</i> ;' and <i>before</i> 'and गौड़,' <i>add—</i> 'कनिज <i>kanil</i> in South Bhagalpur.'	
1	<i>After</i> 'chānch,' <i>add—</i> 'or पख पराती <i>pak parti</i> .'	
.....	801	<i>After</i> 'melani,' <i>add—</i> 'or छिटा <i>chitta</i> ,' and <i>also add—</i> 'Irrigation from wells is कुँदिया बास <i>kunriya chāe</i> in South Bhagalpur.'	
.....	808	<i>For</i> 'होरती <i>horati</i> ' <i>read</i> 'हैवती <i>henuti</i> .'	
.....	812	<i>For</i> 'धन कियारी <i>dhan kiyāri</i> ' <i>read</i> 'धनकियार' <i>dhankiyāri</i> .'	
.. ..	814	<i>After</i> 'बीटो <i>bito</i> ,' <i>add—</i> 'or बेरो <i>bero</i> .'	
.....	..	<i>After</i> 'laugāchhi,' <i>add—</i> 'or नौगाछी <i>naugāchhi</i> .'	
.....	815	<i>Add—</i> 'Land producing brushwood is जाँटी <i>jānti</i> in South Bhagalpur.'	
.....	818	<i>After</i> 'phāran,' <i>add—</i> 'and in South Bhagalpur हर समौज <i>har samaudh</i> .'	
.....	827	<i>After</i> 'dahina,' <i>add—</i> 'and in South Bhagalpur उखर हास <i>ukhar hās</i> .'	
.....	828	<i>For</i> 'bhāunriya' <i>read</i> 'bhāunriya,' and <i>add—</i> 'in South Bhagalpur मण्डो जीत <i>mando jot</i> or चीनम <i>chānmandi</i> .' <i>For</i> 'जवाजेड़ी' <i>read</i> 'जवा जेड़ी,' and <i>after</i> 'other names current are,' <i>add—</i> 'जमर <i>lamti</i> in South Bhagalpur.'	

Ltne.	Section.	
.....	830	<i>For 'हैगात्र' read 'हैगात्र.'</i>
Last	<i>For 'हरकी बाबा' read 'हरकी बाबा.'</i>
.....	837	<i>For 'सौंके ले' read 'सौंके,' and for 'हैभिया' read 'सैभिया.'</i>
2	<i>After 'somāta,' add—' or हर समौष har samaudh.'</i>
.....	842	<i>Add—' A ploughman who works for advances is सापौख saonkh in South Bhagalpur.'</i>
.....	848	<i>Add—' Manure is also called हुरा hūra in South Bhagalpur.'</i>
.....	850	<i>Add—' Heavily-manured land is also said to be पटात्र patāēl north of the Ganges.'</i>
.....	856	<i>Add—' Barren seeds are called कुब्बी kubbi in South Bhagalpur.'</i>
3	<i>For 'बावर' read 'बावग.'</i>
.....	859	<i>After 'barua,' add—' and in South Bhagalpur कुब्बी kubbi.'</i>
.....	862	<i>After 'benga,' add—' and in South Bhagalpur बिचरा bichra or बिहन्तर bihantar.</i>
.....	<i>For 'बीहन्तर' read 'बिहन्तर.'</i>
.....	864	<i>Add—' The bamboo on which the seedlings are carried is called धरङ्गी dharangi in South Bhagalpur.'</i>
.....	866	<i>Add—' Hoeing is called कौनीनी kelauni or कनौनी kamauni in South Bhagalpur.'</i>
.....	867	<i>After 'kelauni,' add—' or कनौनी kamauni.'</i>
.....	871	<i>For 'बकौदा' read 'बकौदार.'</i>
.....	873	<i>Add—' Cane-cutting is पतौर पारब pataur pārāb in South Bhagalpur.'</i>
.....	875	<i>After 'agra,' add—' or अगगा alga.'</i>
1	<i>For 'jharjharāēl' read 'jharjharāēl.'</i>
.....	887	<i>Add—' Treading grain is दमौही damāhi in South Bhagalpur.'</i>

Page.	Line.	Section.	
192	888	<i>Add—</i> 'The first treading out of the grain is also called <i>खूचा khūa</i> or <i>खोचा khaa</i> , and the second treading <i>तरकार tarjār</i> in South Bhagalpur.'
"	3 from bottom.	<i>For</i> 'दोगडा <i>dogha</i> ' read 'दोगडा <i>dogaha</i> .'
193	891	<i>After</i> 'खूचा <i>khūa</i> ,' <i>add—</i> 'or <i>खोचा khaa</i> or <i>पौर paur</i> .'
94	894	<i>Add—</i> 'Loose straw that has been threshed is <i>नीचा nīca</i> in South Bhagalpur.' <i>After</i> 'newāri,' <i>add—</i> 'or in South Bhagalpur <i>गनौरी gabhauri</i> .'
"	895	<i>Add—</i> 'घोरान <i>ghoran</i> is also used in South Bhagalpur.'
95	896	<i>After</i> 'thathero,' <i>add—</i> 'When applied to <i>janera (holcus sorghum)</i> .'
96	902	<i>After</i> 'kurtāli,' <i>add—</i> 'when between tenant and subtenant.'
98	911	<i>For</i> 'खूद काशत <i>khūd kāshī</i> ' read 'खुदकाशत <i>khudkāshī</i> .'
101	915	<i>Add—</i> 'A man irrigating is in South Bhagalpur <i>लरवाहा larwāha</i> .'
103	918	<i>After</i> 'dharika,' <i>add—</i> 'or <i>उपादा upā</i> .'
104	922	<i>Add—</i> 'The spring is in South Bhagalpur also <i>धूर bhūr</i> or <i>सोचा soa</i> .'
108	939	<i>Add—</i> The 'wooden framework is called <i>जलावा jalāla</i> in South Bhagalpur.'
14	5	<i>For</i> 'सुचाक' read 'सुचा.'
"	958	<i>For</i> 'दूचा' read 'दूँचा.'
24	14	<i>For</i> 'खौँचा' read 'खोरचा.'
26	8 from bottom.	<i>For</i> 'नच' read 'नेच.'
28	4	<i>For</i> 'रहरैठा' read 'रहरैठा.'
"	6	<i>For</i> 'देदी' read 'दुँदी.'
30	1001	<i>For</i> 'मदाएच' read 'मडाएच.'
47	10	<i>For</i> '1464' read '1458.'

Page.	Line.	Section.	
248	1050	<i>For 'भीठ bhīṭ' read 'भीठ bhīṭh.'</i>
253	5 from bottom.	<i>For 'गलङ्क्या' read 'गैलङ्क्या.'</i>
273	In last column, <i>for 'ससग्नी' read, 'ससग्नी.'</i>
274	10 from bottom.	<i>For 'सवाव' read 'सावव.'</i>
280	16 from bottom.	<i>For 'वरसे' read 'वरसे.'</i>
"	4 from bottom.	<i>For 'सानवास' read 'सानावव.'</i>
281	3	<i>For 'neede' read 'need.'</i>
290	1110	<i>For 'डेर' read 'डेर.'</i>
292	1117	<i>For 'रककट' read 'करकट.'</i>
299	1147	<i>For 'उदकर' read 'उदकर.'</i>
300	1151	<i>After 'kāś charāī,' add—'काह चराइ kāh charāī.'</i>
310	13	<i>For 'नङ्पाटी' read 'नङ्पाटी.'</i>
"	15	<i>For 'असेन' read 'सेअन.'</i>
"	17	<i>For 'पोरा' read 'चारो.'</i>
316	10 from bottom.	<i>For 'टकही takahi' read 'टकही takhi.'</i>
318	12 from bottom.	<i>For 'कोयाली koyāli' read 'कोपाली koḍli.'</i>
322	1209b	<i>After 'rent-free,' add—'or revenue-free.'</i>
323	8 from bottom.	<i>For '1487' read '1482.'</i>
330	2	<i>For 'money rents are always assessed,' read 'extra money rents are assessed.'</i>
333	8 from bottom.	<i>For 'काडनी' read 'काडनि.'</i>
337	7	<i>For 'कोइया' read 'कोइया.'</i>
357	4 from bottom.	<i>For 'नेइराह' read 'नेइराह.'</i>
359	1285	<i>For 'बरेनि' read 'बरेनी.'</i>
360	1288	<i>For 'बका' read 'बैका.'</i>

Page	Line.	Section.	
366	1323	<i>Add at end of section—'and in West Tirhut लठकर lathangar.'</i>
369	1338	<i>Add at end of section—'and in West Tirhut खिरखियाणी khirkhiyauni.'</i>
372	1349	<i>Add—'The ceremony of cutting the nails is called in West Tirhut नौह छिल्लो nauh chhilli.'</i>
389	4 from bottom.	<i>For 'दोनी doni' read 'दोनी donni.'</i>
391	3 from bottom.	<i>For 'nagra' read 'nagar.'</i>
412	1461	<i>For 'धारनिक' read 'धारनिक.'</i>
APPENDIX.			
2	No. 2	<i>For 'खसरा' read 'खसरा.'</i>
„	No. 2a	<i>For 'गफराजुद' read 'गज गफराजुद.'</i>
14	14	<i>For 'am' read 'ām.'</i>
		15	<i>For 'बडा' read 'बडा.'</i>

CONTENTS.

	PAGE.
DIVISION I.—IMPLEMENTS AND APPLIANCES USED IN AGRICULTURE AND RURAL MANUFACTURES	1
Subdivision I.—Implements used in preparing land for cultivation	<i>ib.</i>
CHAPTER 1.—The plough	1—5
" 2.—Mattocks and spades	5—6
" 3.—The harrow	7—8
" 4.—Rakes used in field work	8
" 5.—Pickaxes, pitchforks, &c.	8—9
Subdivision II.—Implements used in sowing, weeding, and irrigation	9
CHAPTER 1.—Baskets	9—11
" 2.—Brooms	11—12
" 3.—Implements used in weeding, &c.	12—13
" 4.—Implements used in connection with irrigation	<i>ib.</i>
Subdivision III.—Appliances used in field-watching	<i>ib.</i>
CHAPTER 1.—The sling	13—14
" 2.—The scarecrow	<i>ib.</i>
" 3.—The watchman's platform	14—15
Subdivision IV.—Implements used in harvesting	15
CHAPTER 1.—The sickle or reaping-hook	15—16
" 2.—Rakes used on the threshing-floor	<i>ib.</i>
" 3.—Granaries	16—18
Subdivision V.—Implements and appliances used in connection with cattle	18
CHAPTER 1.—The fodder-cutter and trough	18—19
" 2.—The muzzle and blinkers	19—20
" 3.—The whip and goad	20—21
" 4.—Hobbles for cattle	<i>ib.</i>
" 5.—Ropes	21—24
" 6.—Pads for cattle	<i>ib.</i>
" 7.—Grain-bags and paniers for loaded cattle... ..	25
" 8.—Canvas, leather, or tarpaulin covers	<i>ib.</i>
" 9.—Vessels from which animals are fed	<i>ib.</i>
" 10.—Dairy utensils	25—27
Subdivision VI.—Appliances used in the conveyance of goods or passengers	<i>ib.</i>
CHAPTER 1.—The country cart	27—28
" 2.—The large, complete country cart	28—37
" 3.—The light country cart	37—38
" 4.—The bullock carriage	38—39
" 5.—The pony carriage	40—42
" 6.—The country boat	42—45
" 7.—The litter	45—46
Subdivision VII.—Appliances used in rural manufacture	46
CHAPTER 1.—Appliances used in the manufacture of oil	46—49
" 2.—Appliances used in the manufacture of sugar	50—60

	Page.
CHAPTER 3.—Appliances used in the manufacture of indigo ...	60—62
" 4.—The spinning-wheel	62—69
" 5.—The weaver's loom	69—76
" 6.—The saltpetre manufacture	76—77
" 7.—A distillery of country liquor	77—78
Subdivision VIII.—Appliances used by miscellaneous village traders and professionals	79
CHAPTER 1.—The palm-juice seller	79—80
" 2.—The bird-catcher	<i>ib.</i>
" 3.—The barber	80—81
" 4.—The country surgeon	<i>ib.</i>
" 5.—The farrier	<i>ib.</i>
" 6.—The washerman	81—82
Subdivision IX.—Tools and appliances used by country artizans	83
CHAPTER 1.—The carpenter and turner	83—85
" 2.—The blacksmith	85—88
" 3.—The mason or bricklayer	88—90
" 4.—The grain-parcher	90—92
" 5.—The baker	92—93
" 6.—The confectioner	93—94
" 7.—The tobacco-manufacturer	95
" 8.—The pipe-maker	96—97
" 9.—The pipe-stem maker	<i>ib.</i>
" 10.—The cotton-carder	98
" 11.—The shoe-maker	98—99
" 12.—The blanket-weaver	99—100
" 13.—The fancy silk or fringe-maker	100—101
" 14.—The embroiderer	<i>ib.</i>
" 15.—The dyer	101—102
" 16.—The wood-painter	<i>ib.</i>
" 17.—The tinman	102—103
" 18.—The jeweller	103—105
" 19.—The lapidary	105
" 20.—The seal-maker	106
" 21.—The gold-washer	<i>ib.</i>
" 22.—The brazier	107—108
" 23.—The brass-founder	<i>ib.</i>
" 24.—The brass-bangle maker ...* ..	<i>ib.</i>
" 25.—The glass-maker and glass bangle-maker	108—110
" 26.—The lac bangle-maker	<i>ib.</i>
" 27.—The potter	111—112
" 28.—The firework-maker	112—114
" 29.—The bookbinder	114—115
" 30.—The rope-twister	115—116
" 31.—The weaver's brush-maker	<i>ib.</i>
" 32.—The bow-maker	<i>ib.</i>
" 33.—The weapon-cleaner	<i>ib.</i>
DIVISION II.—DOMESTIC APPLIANCES AND UTENSILS	117
Subdivision I.—Appliances used in the preparation of food	<i>ib.</i>
CHAPTER 1.—Sieves	117—118
" 2.—The pedal for husking grain	118—119
" 3.—The pestle and mortar used for husking grain	119—120
" 4.—The hand grinding-mill	120—121
" 5.—The grindstone for spices	<i>ib.</i>
" 6.—The roller for making paste	<i>ib.</i>

	PAGE.
Subdivision II.—Domestic furniture	120—121
CHAPTER 1.—Stool	121—122
" 2.—The bed and cot	122—123
" 3.—The weighing scales	123—124
" 4.—Nets	124—126
" 5.—The pad used for supporting water-pots, &c., on a woman's head	<i>ib.</i>
" 6.—The stick	126—127
" 7.—Boxes	127—128
" 8.—Metal vessels used in cooking and for ordinary domestic purposes	129—134
" 9.—Earthen vessels	134—140
" 10.—Wooden vessels	141
" 11.—Leather vessels	141—142
" 12.—Leaf platters	<i>ib.</i>
" 13.—Stands for vessels	<i>ib.</i>
Subdivision III.—Clothes, ornaments, &c.	<i>ib.</i>
CHAPTER 1.—Clothes	142—160
" 2.—Carpets and mats	<i>ib.</i>
" 3.—Jewelry... ..	151—156
Subdivision IV.—Appliances used in worship	156—157
DIVISION III.—SOILS	159
CHAPTER 1.—Classification of soils	<i>ib.</i>
" 2.—Soils classified according to their distance from the village site	159—160
" 3.—Soils classified according to their constituent elements	160—162
" 4.—Soils and water action	<i>ib.</i>
" 5.—Muddy and water-logged soils	162—163
" 6.—High lands and low lands	<i>ib.</i>
" 7.—Bavines, mounds, &c.	163—164
" 8.—Stony soils	<i>ib.</i>
" 9.—Cultivated and waste	165
" 10.—Fallow	165—166
" 11.—Richness and poorness of soil	<i>ib.</i>
" 12.—Irrigated and dry lands	<i>ib.</i>
" 13.—Lands which retain and which do not retain moisture	167
" 14.—Lands bearing a single and a double crop	<i>ib.</i>
" 15.—Terms used in connection with different crops	167—169
" 16.—Land impregnated with salt, &c.	<i>ib.</i>
DIVISION IV.—GENERAL AGRICULTURAL OPERATIONS	171
Subdivision I.—Ploughing and harrowing	<i>ib.</i>
CHAPTER 1.—Ploughing and harrowing	171—174
" 2.—Fields	174—175
" 3.—Boundaries	175—176
" 4.—Furrows	<i>ib.</i>
" 5.—Miscellaneous terms used in *connection with ploughing	176—177
" 6.—Ploughman and agricultural labourers generally	177—178
" 7.—Reciprocal assistance in cultivation	178—179
Subdivision II.—Manuring	<i>ib.</i>
CHAPTER 1.—Kinds of manure	179—180
" 2.—Modes of manuring	<i>ib.</i>
" 3.—Manure used as fuel	180—181
Subdivision III.—Sowing and transplanting	<i>ib.</i>
CHAPTER 1.—Sowing	181—182
" 2.—Modes of sowing	182—183

CHAPTER 3.—Seed-beds and nurseries
" 4.—Sowing time
" 5.—Transplanting
Subdivision IV.—Digging, hoeing, and weeding
CHAPTER 1.—Digging	184—
" 2.—Hoeing
" 3.—Weeding	185—
Subdivision V.—Watching crops	186—
" VI.—Reaping and gleanng
CHAPTER 1.—Reaping	187—
" 2.—Cutting of unripe crops
" 3.—Gleaning
Subdivision VII.—Threshing and winnowing
CHAPTER 1.—The threshing-floor
" 2.—Sheaves and bundles	189—
" 3.—Treading out grain	191—
" 4.—Crops on the threshing-floor	193—
" 5.—Winnowing	195—
" 6.—Miscellaneous
Subdivision VIII.—Division of crops
CHAPTER 1.—Division and valuation	196—
" 2.—The shares into which the crop is divided	197—
" 3.—Deductions and remissions	98—
" 4.—Mode of division	199—
Subdivision IX.—Irrigation
CHAPTER 1.—Irrigation generally
" 2.—Kinds of irrigation
" 3.—Irrigation from canals
" 4.—Ditto wells	203—
" 5.—Construction of wells	204—
" 6.—The lever used in raising water	206—
" 7.—The skin bag used for drawing water
" 8.—Other well appliances connected with irrigation	208—
" 9.—The pathway for bullocks, &c.
" 10.—The workmen employed at the well	209—
" 11.—The Persian wheel
" 12.—Irrigation from tanks and streams
" 13.—Water-lifts and other terms common to irrigation by the swing-basket and the spoon-lever...
" 14.—Water-channels	211—
DIVISION V.—AGRICULTURAL PRODUCTS AND THEIR ENEMIES
Subdivision I.—Agricultural products
CHAPTER 1.—Wheat	213—
" 2.—Mixed crops	214—
" 3.—Barley and oats
" 4.—Rice	215—
" 5.—Indian corn or maize	223—
" 6.—The large millet	224—
" 7.—The small bulrush millet
" 8.—The small millets	225—
" 9.—Pulses	227—
" 10.—Peas
" 11.—Gram	231—
" 12.—Sugarcane	232—
" 13.—Cotton	237—

CHAPTER 14.—Tobacco	239—241
" 15.—Opium poppy	241—243
" 16.—Hemp	<i>ib.</i>
" 17.—Indigo	243—244
" 18.—Other dyes	244—246
" 19.—Oil-seeds	246—247
" 20.—Fibres	247—248
" 21.—Betel	248—249
" 22.—Garden crops	250—257
Subdivision II.—Insects and causes of injury to crops	<i>ib.</i>
CHAPTER 1.—Destructive insects and diseases	257—265
" 2.—Noxious weeds	265—269
" 3.—Miscellaneous	269—270
DIVISION VI.—AGRICULTURAL TIMES AND SEASONS	271—285
DIVISION VII.—CATTLE AND OTHER DOMESTIC ANIMALS	287
CHAPTER 1.—Cattle generally	<i>ib.</i>
" 2.—Bulls	<i>ib.</i>
" 3.—Bullocks	287—291
" 4.—Cows and breeding	291—292
" 5.—Calves	292—293
" 6.—Buffaloes	293—294
" 7.—Goats	<i>ib.</i>
" 8.—Sheep	<i>ib.</i>
" 9.—Pigs	294—295
" 10.—Horses, mules, and asses	<i>ib.</i>
" 11.—Elephants	295—296
" 12.—Camels	<i>ib.</i>
" 13.—Straying of cattle	<i>ib.</i>
" 14.—Colours of cattle	296—297
" 15.—Hides	<i>ib.</i>
" 16.—Cattle slaughter	297—298
" 17.—Feeding cattle	298—299
" 18.—Pasturage	<i>ib.</i>
" 19.—Fences	300
" 20.—Grazing-fees	<i>ib.</i>
" 21.—Cow-houses and enclosures for cattle, cattle-owners, &c.	300—301
" 22.—Cattle-dealers	<i>ib.</i>
" 23.—Milk and its preparations	301—303
" 24.—Cattle diseases	304—306
" 25.—Cattle fodder	306—311
DIVISION VIII.—LABOUR, ADVANCES, WAGES, AND PERQUISITES	313
CHAPTER 1.—Pay and advances to labourers	313—314
" 2.—Advances to tenants	314—315
" 3.—Dues paid by tenants	315—320
DIVISION IX.—LAND TENURES	321
CHAPTER 1.—Tenures	<i>ib.</i>
" 2.—Proprietary tenures	321—323
" 3.—Intermediate tenures	323—324
" 4.—Shares and sharers	324—325
" 5.—Cultivating tenures	325—327
" 6.—Rents	327—330

DIVISION X.—THE NATIVE HOUSE	
CHAPTER 1.—The native house	3
" 2.—Parts of a house	3
" 3.—Materials used in the construction of the house	3
DIVISION XI.—FOOD	
CHAPTER 1.—Meals
" 2.—Kinds of food	3
DIVISION XII.—CEREMONIES AND SUPERSTITIONS OF RURAL LIFE	
CHAPTER 1.—Marriage	3
" 2.—Wedding ceremonies generally	3
" 3.—Special wedding ceremonies amongst the Hindus	3
" 4.—Marriage ceremonies amongst the Musalmāns	3
" 5.—Birth customs generally	3
" 6.—Ceremonies peculiar to the birth of a Hindu child	3
" 7.—Birth customs amongst Musalmāns	3
" 8.—Disposal of the dead amongst the Hindus	3
" 9.—Disposal of the dead amongst Musalmāns	3
" 10.—Ceremonies at ploughing and sowing and transplanting.	3
" 11.—Harvest ceremonies	3
" 12.—Miscellaneous	3
" 13.—Arbitrations, oaths, &c.	4
" 14.—Miscellaneous superstitions	4
DIVISION XIII.—TRADE, MONEY-DEALINGS, AND ACCOUNTS	
CHAPTER 1.—Trade and bazār accounts	4
" 2.—Accounts between landlord and tenant	4
" 3.—Interest, discount, and commission	4
" 4.—Rates of interest	4
" 5.—Mortgage	4
" 6.—Miscellaneous	4
DIVISION XIV.—WEIGHTS AND MEASURES	
CHAPTER 1.—Measures of length	4
" 2.—Superficial measure
" 3.—Measures of proportion	4
" 4.—Measures of weight	4
APPENDIX

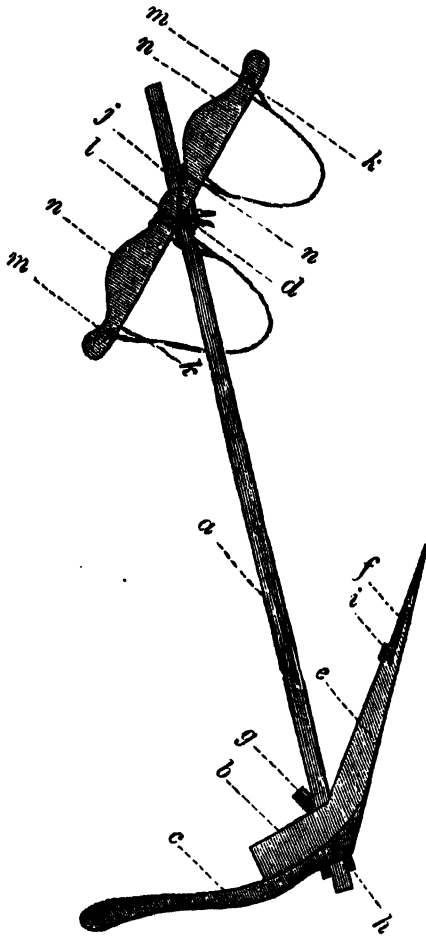

The Country Plough.

(NOTE.—The front portion of the body is given in section, so as to show the position of the share.)

DIVISION I.

IMPLEMENTS AND APPLIANCES

USED IN

AGRICULTURE AND RURAL MANUFACTURES.

SUBDIVISION I.

IMPLEMENTS USED IN PREPARING LAND FOR CULTIVATION.

CHAPTER I.—THE PLOUGH.

1. The ordinary country plough is generally known as **हर** *har*. Sometimes the Hindi form of the word, **हल** *hal*, is used. In Gaya the word **लंगल** *lāngal* is also used.

2. **खिनौरी** *khinauri* is used for an old or worn plough. In the South-East and in North-West Tirhut this is **ठेंठी** *thenthi*, and generally over North-East and South Tirhut **ठेंठा** *thentha*. In Shahabad it is **खुटहरा** *khutahra*. A new plough is **नवठा** *nawtha* or **नौठा** *nautha* to the west, **नवघर** *nawghar* in Champāran, and **लवठा** *lawtha* generally over North-East and South Tirhut.

3. In West Bihār and South Bhagalpur **संगह** *sānga*, and in South Munger **संगह** *sāngah*, mean the plough and all its appurtenances, as in the sentence **संगह (or हर संगह) लेने आव बहियार** *sānga (or har sānga) lene āw bahiyār*,—bring the plough, &c., to the field.

4. The various parts of the common plough are as follows :—

5. *The beam (a).*—North of the Ganges this is **हरिस** *haris*, and so also in Shahabad. In East Tirhut it is also called **हरसी** *haris*. In Patna, Gaya, and South Munger it is **संघ** *sāngh*. In South Bhagalpur it is **रस** *ra*. **हरिस** *haris* is, however, understood more or less everywhere.

6. *The body (b).*—This is everywhere **हर har**.

7. *The handle or stilt (c).*—In Shahabad and north of the Ganges this is **परिहथ parihath**; in the eastern portion of the latter tract it is also **लगन lāgan**. **लगना lagnā** is used in South Munger, Patna, and Gaya, and **नांगनी nāngno** in South Bhagalpur. In South-Western Shahabad **परिहत parihat** is used. The knob at the end of the body near the handle is in Patna **चंदवा chandwa**, in Gaya **चाँदी chāndi**, north of the Ganges and in Shahabad **मूठ mūth** (or in the south-west of the district **चंदुली chanduli**), and in the south-east **मुठिया muthiya**. In South Bhagalpur **मकरी makri** is a piece used for mending it when broken. The first, second, and fourth names are only used if it is a separate piece of wood.

8. *The notches on the beam (d)*, by which the share is raised or lowered.—In Sāran **खेदा kherha**, in Gaya **खेदी khenrhi**, and in Shahabad **खेही kherhi**. In Patna they are **खेवा kheha**, in Champāran **खाना khāta**, and throughout Tirhut **खही khārhi**. In South-East Tirhut it is also **खरहा kharha**, and in South-East Bihār **खौरा khonrha** or **कार kār**.

9. *The sole (e)*, in which the share is fixed.—

In West Bihār it is **टोर tor** or **टोरा tōra**. In East Bihār it is **नास nās** or **नासा nāsa**.

North of the Ganges the thicker end of the sole is called **माँच mānth** or **माँचा māntha**.

10. *The share (f).*—Everywhere **फार phār**. In North-East Tirhut also **फारा phāra** or **फाला phāla**, and in South-East Tirhut also **लोहामा lohāma**.

11. *The wedge fixing the beam to the body (g).*—North of the Ganges and in Shahabad and South Munger this is **पाट pāt**. Variants are **पटा patta** (Gaya), **पाटा pāta** (South Tirhut and Patna), and **पाटो pāto** (South Bhagalpur).

A second wedge is sometimes added, which is known as **चेही chāhi** everywhere north of the Ganges and in Gaya and the south-west, and also as **खेल्की chelkhi** in South-East Tirhut. In East Tirhut it is also called **चेरी cheri**. Another name is **पाचड़ pāchar** (in North-East Tirhut and Shahabad), or **पचड़ी pachri** everywhere south of the Ganges. In South Bhagalpur it is called **उपर पाटो upar pāto**.

12. *The peg (h)* passing through the shaft at the end, to prevent the body coming off.—This is **बाराँ बरदिँ barāin** generally, or **बरेँ barain**

in Champāran and Tirhut; the latter is also used in South Munger. Other forms are बरेन *baren* in North-East Tirhut, बरहण *barhan* in Sāran, बरेनी *baraini* in Patna, and बरन *baran* in Shahabad. Other names are सब धरिया *sabh dhariya*, सत धरिया *sat dhariya*, in Patna, and सबधर *sabhdhar* in Gaya, because it holds the whole plough together. Also तरैल *taraila* in South Bhagalpur, तरैली *taraili* in South-West Shahabad, and हनुना *humna* in Patna.*

13. *The iron clamp (i)* for preventing the share falling off.—करुआर *karuār* or करुआरा *karuāra* everywhere to the west. A variant is करुआरी *karuāri* (Patna, Champāran, and West Tirhut). In South-West Shahabad it is also called कुरा *khūra*. In Patna it is also called जोंका *jonka*, and the same name is current all over Bihār. जोंकी *jonki* and चोभी *chobhi* are also used in South-East Tirhut. In North-East Tirhut a wedge is also used for the same purpose, and is called गासी *gāsi*.

14. *The yoke*.—North of the Ganges always पाळो *pālo*; so also in Patna, Gaya, and South Munger, with a variant पाळत *pāla* in South Bhagalpur. In Shahabad and Gaya the word is generally जुआठ *juāth*, which is also sometimes used in Sāran and the east. Sometimes it is made up of two bars. The upper bar then is considered the yoke proper, and is hence usually called the जुआठ *juāth*. The lower bar is generally तरसेला *tarsaila*.

This double-bar arrangement is not commonly found in the plough yoke. It is more usually met with in the yoke for well irrigation (मोट *mot*); so also the two following pins. As a general rule पाळो *pālo* or जुआठ *juāth* (according to locality) may be safely used for the single-bar plough-yoke and for the double-bar irrigation yoke, and जूआ *jūa* for the single-bar cart-yoke. See § 938.

15. *The outer pins*, which join the two bars of the yoke, are सेला *saila* or समेल *samail* to the west and कनेल *kanail* to the east. They are also कनकिली *kankilli* in South Bhagalpur.

16. *The inner pins* are समेल *samail* or (Patna and the south-east) समैला *samaila* and (Gaya) समैया *samaiya*.

17. *The leather thongs (j)*, which attach the yoke to the beam of the plough.—These are from Patna to the east of the South Gangetic tract, and in Champāran, नारन *nāran*, with a variant लरनी *larni* in

* About हुनना *humna* there is a story of a Jolha (the proverbial fool of Bihār stories) who found a *humna* on the road and cried out in his foolishness पाचों हुर को हुनना, खेतीकरव बनाय *pāchōn har ke humna, kheti karav banāy*,—I have found the rear peg of a plough, I'll turn a farmer at once.

North-West and South-East Tirhut, and optionally *लारन* *lāran* in South-East Bihār. *नाचा* *nācha* and *नरैची* *naraiči* are used in Shahabad, and variants of the former word occur in *लढा* *ladha* (South-East Tirhut), *लेवा* *leidha* or *लावा* *lādha* (North-East Tirhut), and *हर लधी* *har ladhi* or *हर नाचा* *har nādha* over South Tirhut generally. *नाचा* *nācha* is also used in Gaya. *हर ना चा* *har nādha* in Sāran is only used when they are of string. When they are of leather, in that district they are called *दुवाही* *duāhi*. South Bhagalpur has *दोंडा* *donra* or *लेवा* *leidha*.

18. *The ropes (k) which go round the bullocks' necks.*—These are everywhere except in the extreme west *जोती* *jōti*. In the extreme west (Sāran, Champāran, and Western Shahabad) the masculine form, *जोता* *jōta*, is the usual one. In North-East Tirhut they are also *सनेल* *sanēl* or *सनेल* *samail*, and in South Bhagalpur *फॉंस* *phānsa*.

19. *The projecting knob (l) in the middle of the upper part of the yoke.*—Round this the thongs which fasten the yoke to the beam are fixed. This is everywhere *महादेवा* *mahādewa*. Variants are *महादेवी* *mahādeo* (Patna and Gaya) and *महदवा* *mahdawa* (South Munger). In South Bhagalpur it is *मंजवार* *manjhvāra*.

20. *The notches (m) near each end of the yoke.*—To these the ropes which go round the bullocks' necks are fixed. These are *खॉरी* *khāri* in Patna, with variants *खारी* *khārhi* in South-East Tirhut and *खेरी* *kherhi* to the west. South-West Shahabad has *खड़ी* *khaddhi*. In Gaya the word used is *कनौची* *kanausi*, and in South Bhagalpur *खॉटा* *khāta*, while *सिमल* *simal* or *नकळी* *nakli* are optional names in South-East Tirhut.

21. *The leaf of the yoke (n).*—This is *पत्ता* *patta*, *पजा* *palla*, or (in South Munger) *पलई* *palaī* and (in Sāran) *पाना* *pāna*.

22. *The trough in which the share lies when fixed in the body is खोल* *khol*, or in South Bhagalpur *खोली* *kholi*.

23. *The bamboo whip with which the bullocks are driven is पेना* *paina*, and its *lash* is *छिंति* *chhīti* in North-East Tirhut. Other names will be found in § 98 and ff.

24. *A drill plough.*—This is generally *तार* *tār*, with variants in South-East Tirhut *तॉरी* *tāri* and *टोर* *tor* in South Munger. The share is *तरसूई* *tarsūi*. *खिला* *khilla* is the nail which fastens the share to the body. The bamboo pipe is in West Bihār *बाँसा* *bānsa*, also sometimes *बसा* *bansa* in Shahabad. In East Bihār this is generally *चोंगा* *chonga*, except in South Munger, where it is *हर चॉरी* *har chāri*.

The cup at the top, into which the grain is poured, is in West Bihār **माला** *māla* or **मालवा** *mālwa*. In East Bihār it is **पैला** *pāila* (sometimes spelt **परला** *pāila* or **पपला** *paēla*) or **माली** *māli*. In South Munger it is also **अकरी** *akhri*, and in Patna **अकरी** *akri*.

25. *The sharpening of a ploughshare is called as follows in the various districts:—*

Shahabad : **धार पिटावल** *dhār pitāwal* ; or in the south west of the district **धार फरगावल** *dhār phargāwal*.

Patna : **धार असराय** *dhār asrāēb*.

Gaya : **असार** *asār*.

South Munger and South Bhagalpur : **धार पजाव** *dhār pajāw* or **असार** *asār*.

North of the Ganges generally : **धार पिटावल** *dhār pitāwal*.

Also, North-West Tirhut and Sāran : **धार पिजावल** *dhār pijāwal*.

North-East Tirhut : **धार बनाव** *dhār banāēb*.

South-East Tirhut : **धार करा काय** *phār karā lāēb*.

26. When a man wishes to *plough deep* he harnesses the yoke higher up the beam in the notches (*d*). This is called in West Bihār **औगार** *augār*. In North-West Tirhut it is called **लगार** *lagār*, and in the rest of Tirhut **तरक** *tarakh*. In South-West Shahabad it is called **अवाय** *awāē*, in South Munger **ढाहा** *thārha*, and in South Bhagalpur **ढाह** *thārkh*. Light ploughing is done in the converse way, and is known everywhere as **सेव** *sev*, or in North-East Tirhut **सेब** *seb*.

CHAPTER II.—MATTOCKS AND SPADES.

27. A large mattock is in West Bihār and Gaya **फौरा** *phauwa*. Variants are **फहोरा** *phahora* (Patna and Gaya), **फहोरा** *phahora* (South Munger), **फहोरा** *phaōra* (Patna and Gaya), and **फहरा** *phahura* or **फरवा** *pharūha* in Shahabad. In South-West Shahabad it is **फरवा** *pharsa*. In Tirhut it is **कुदर** *kudār*, and in South Bhagalpur and South Mungēr **कोदर** *kodār*. Another name current in Gaya is **जाम** *jām* or **जामा** *jhāma*. In the same district **अभि** *abhi* is a heavy kind of wooden spade tipped with iron for hard soils, and **खुरनी** *khurni* or **खुदनी** *khudni* is a kind of spade.

28. A mattock with a narrower blade is **कुदारी** *kudāri*, **कोदारि** *kodāri*, or **कोदारी** *kodāri*. South of the Ganges it is also **कुदाही** *kudāhi*.

कुदाच *kudāl* and कुदर *kudār* are often used to signify also the smaller variety. In South Bhagalpur it is ठेंडी कौदर *thenthi kodār*.

29. The handle is बेंट *bent*, and the upper end of it, which projects beyond the socket, is हूरा *hūra* or हूर *hūr*, or (in South-West Tirhut) मुठा *mūtha*. Other names for this end are एरा *era* or अरानी *ārāni*, and in South Bhagalpur पाठ *pāta*. The ring or socket in the blade, to which the handle is fixed, is पास *pās* or पासा *pāsa* (or in South Bhagalpur पासो *pāso*). In South-West Shahabad it is पंवाँरी *pamwānri*, and in South Munger (optionally) पसाटा *pasāta*. The curved part of the blade is in Sāran and Patna फरी *phari*. Elsewhere, north of the Ganges and in South Munger, फरकी *pharki*. In Patna and South Munger it is also called फल *phal*, in South Bhagalpur फरो *pharo*, and in Gaya फारी *phāri*. In Shahabad it is धार *dhār*, and in the south-west of the district दम्प *damp*. The place where the ring and the blade meet is कण्ठी *kanthi* in Patna and Gaya, नहिन *nahin* in Shahabad, सन *san* or कण्ठ *kanth* in South Bhagalpur, and सुन *sun* in South Munger. In Sāran the part of the handle which is grasped is मुठ *mūth*, and the corners काना *kāna*. A new mattock is नवघर *navghar*, and a worn one ठेंडी *thenthi*.

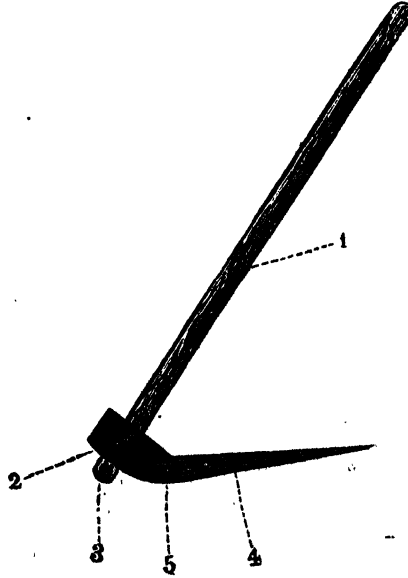

1. *Bent* (handle).

2. *Pāsa* (socket).

3. *Hūra*.

4. *Phari* (blade).

5. *Kanthi* (neck).

The Mattock (Phaura or Kodār).

CHAPTER III.—THE HARROW.

30. This is usually the *flat plank*, with (in the east) a grove along the underside. It is dragged along the ground to break the clods after ploughing, while a man stands on it to give weight. In West Bihār and in South-East Tirhut it is called हेंगा *henga*, and in East Bihār more usually चौकी *chaunki* or चौकी *chauki*. In Patna it is also called सिलवे *silwe*, पटवे *patwe*, or लगवरी *lagāwri*.

31. When drawn by one pair of oxen—one ox at each end—it is called हेंगी *hengi* in Champāran, दुगोड़ी *dugori* in Tirhut, एक हरा *ek hara* in South Bhagalpur, and दोबरदा *dobarda* elsewhere. When drawn by two pair of oxen—one pair at each end—it is called in North-East Tirhut चौगोड़ा *chaugora*, in the rest of Tirhut चरगोरी *chargori*, दो हरा *do hara* in South Bhagalpur, and elsewhere चौबरदा *chaubarda*.

32. The pegs to which the hauling ropes are fastened are generally खूँटी *khūnti*. In Shahabad they are also called सँदु *sanrusa*, and in the south-west of the district गुली *gulli*. In Gaya they are बाँका *baunkha*, in Patna and South Munger बख्खा *bakhkha*, and in South Bhagalpur अंकोरा *ankora*.

33. The hauling ropes are, north of the Ganges generally, and in West Shahabad, बरन्ही *barhi*. North of the Ganges they are also हेंगची *hengachi*. In Shahabad chains used for the purpose are सीकर *sinkar*, and in Patna and Gaya सीकर *sikar* when used with four bullocks abreast. These words are also used in North Tirhut. In Patna they are also चौक नारन *chauk nāran* when of rope. In South-East Tirhut they are also called मरिखर *marikhar*, and in South Bhagalpur जगडोरी *jagdori*. In South Munger they are सीकर *sikar* when made of chain, and मरिखर *marikhar* when made of rope, and मज्जौतर *majhautar* is the rope or leather strap joining the two yokes when four bullocks are used. So also in Patna and Gaya. The last word is मज्जौतर *mujhotar* in East Tirhut. In East Tirhut, when made of leather they are called मैरन *mairan* or मेदन *merhan*, and when made of rope बरन्हा *barha* or बरन्ही *barhi*. Sometimes long strips of bamboo are made to serve as hauling ropes. They are then called in South Munger कुडची *kudāndi*, in South Bhagalpur बसजोती *bansjoti*, and elsewhere अरौषा *arawā*.

34. The channel in the lower part of the plank to break the clods is in South Bhagalpur बघरी *ghaghri* or बार *ghāi*, in South Munger खददा *khadha*, and elsewhere खददा *khaddha*. The channel is generally the

hollow of the stem of the talipot palm, the harrow being composed of the split half of a log of that tree.



1. *Henga* (harrow). 2. *Khūnti* (pegs). 3. *Barhi* (ropes).

The Harrow (Henga or Chauki).

35. The *cylindrical roller* is rarely used in the field. It is called everywhere by a corruption of its English name, viz. रोल *rol*. The block itself is called पल्ला *palla* (Patna), कड़ी *kari* (Gaya), एकठा *ektha* in Shahabad, and लकड़ी *lakri* in South-West Shahabad. Elsewhere it is simply चौकी *chaunki* or चौकी *chauki*.

36. Sometimes the harrow is made of two parallel planks joined together. This is called हंगा *henga* or चौकी *chauki*, &c., as above.

CHAPTER IV.—RAKES USED IN FIELD WORK.

37. Rakes are seldom used. Sometimes a bundle of thorns is dragged over a field to soften the surface when it has been baked hard by the sun after rain or irrigation. This has no special name. In parts of Tirhut the कखा *kanta* or खखोरनी *khakhorni* is a sort of rake or harrow worked by oxen to loosen the soil and extricate weeds from a crop of young rice. A पचपारिया *pachphariya* or (in Sāran) गेहनी *gelhni* is a kind of plough with five shares used in indigo factories.

CHAPTER V.—PICKAXES, PITCHFORKS, &c.

38. *A pickaxe*.—North of the Ganges this is गैना *gainta*, south of the Ganges it is गैना *gainta* or गैनी *gainti*. In South Bhagalpur it is गैना *gaincha*, and in South Munger गैना *gāta*.

39. *The dredger*, used in well-sinking, has various names. In Shahabad, Sāran, and South Tirhut it is चालना *chalna*, and in Champāran

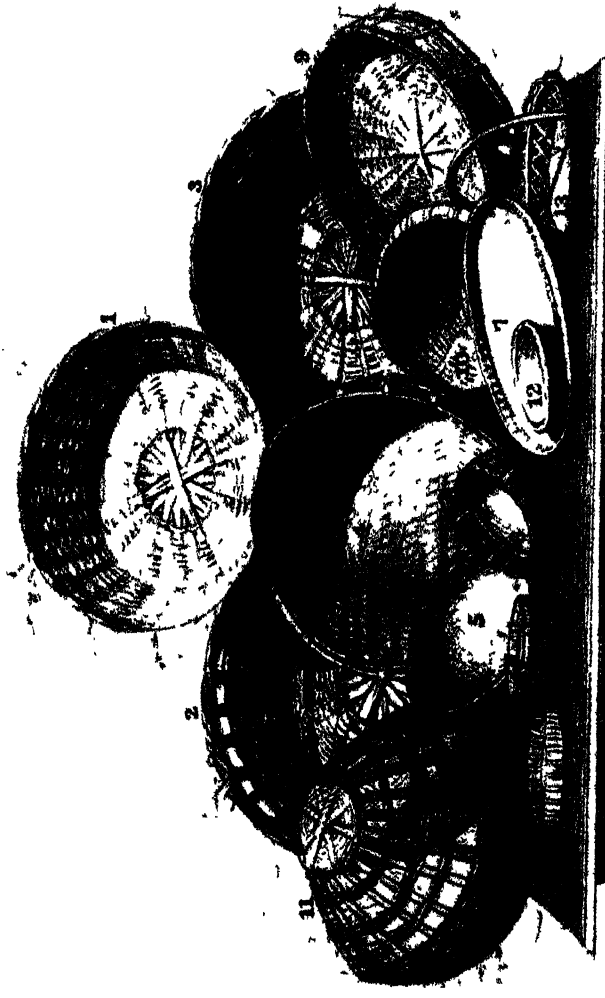

A Collection of Baskets.

1. Ukhainata.	made of split bamboo.	8. Dagri.	made of split bamboo, edge sewn with tal leaves.
2. Ditto	ditto, woven up with tal fibre	9. Dala	split bamboo.
3. Oriya	split bamboo.	10. Tokri	tal slips and bamboos
4. Baura	ditto	11. Tap	bamboo slips.
5. Dewari	ditto, strengthened with tal leaves.	12. Sitahuti	mung grass.
6. Two ditto	split bamboo.	13. Phaldali	flower-basket
7. Dagra	ditto, edge sewn with rattan		

तरङ्गी *tarchhi*. In North-East Tirhut it is चौडी *chhiti*, कठुली *kathuli*, or पथिया *pathiya*. चौडी *chhiti* is also used in South-East Tirhut, where also occur कठुवन *kathuat* and. (also in Shahabad) तगाड़ी *tagāri*. Elsewhere south of the Ganges it is गैता *gainta* or खन्ती *khanti*, and in South Munger चौडा *chhita*.

40. The *pointed iron spear* for tapping the well-spring also has various names, viz. खुण्डा *khunta* north of the Ganges generally, गजाड़ा *gajāra* in Sāran, and गोभन्गी *gobhni* in South-West Tirhut. In Gaya it is खोभन्ना *khobhna*, and in Shahabad खोभन *khobhan*, but in the south-west of the latter district it is खरन्ना *larha*. In South Munger it is देभन *debhan*, and in South Bhagalpur it is गजाड़ा *gajāra* or खन्ती *khanti*.

41. The *hooked stick* for pulling down fruit from trees is generally लग्गा *lagga* or लग्गी *laggi*. The hook of this is अंकुची *ankusi* or (in South Bhagalpur) कानी *kāni*. The long pole with a small net at the end to catch the fruit as it falls is जोडा *jhola*, खोंची *khonchi*, or (in Sāran) जोरा *jhora*. Another optional name in South Munger is जलखरी *jalkhari*.

The short stick thrown up into fruit-trees to bring down fruit is भटखा *jhatha*, and also (in Sāran) लग्गी *lagūsi*.

SUBDIVISION II.

IMPLEMENTS USED IN SOWING, WEEDING, AND IRRIGATION.

CHAPTER I.—BASKETS.

42. Baskets are generally woven of bamboo slips or twigs. Unless otherwise stated, this may be assumed of all the following.

43. Baskets used specially by the sower are called generally जोड़ा *ora*, जोड़ी *ori*, or जोड़िया *oriya* (sometimes made partly with the fibre of the leaves of the tāl palm); also we meet, to the west, चैंटी *chhainti*, and to the east चौडा *chhita* (a large one), चौडी *chhiti* (a small one), or दौरी *dauri*. South of the Ganges they are also called in Patna बट्टा *battā*, (also in Shahabad) दौरा *daura*, or दौरी *dauri* (sometimes made of the culm of the *sik* grass, *andropogon muricatum*), in Gaya (also in North-

East Tirhut) पथिया *pathiya* (also used for feeding cattle), and in South Munger खँचिया *khanchiya*. The only difference amongst all these is that in the case of the दौरा *daura* and दौरी *dauri* the bottom is woven of bamboo slips, like a mat.

44. There are likewise several other kinds of baskets, used indiscriminately for this and other domestic and agricultural purposes. Thus, small straw grain-baskets are चंगेली *changeli* or चंगेरी *changeri*, and sometimes डाली *dāli* or डलिया *daliya*, especially towards the east. In Patna and South Munger they are called बटरी *batri*. Another very similar basket (but still smaller) is called very generally मौनी *maunni* or मौनिया *mauniya*, also बट्टा *batta* in Patna, Gaya, and South Munger, and फुलुकी *phuluki* in East Tirhut. A large open basket made of split twigs of bamboo generally woven up with the fibre of the leaves of the tāl palm is called टोकड़ा *tokra*, डाका *dhākā*, डाकी *dhāki*, षोड़ा *ora*, or चैंटा *chainta*. A smaller variety is called गँजा *ganja*, टोकड़ी *tokri*, डकीया *dhakiya*. When the bottom is very finely woven, so as even to hold water, it is called चोड़ेसा *oraissa*. The धामा *dhāma* is an open basket made of rattan. The खँचा *khaincha* or खँचा *khāncha* is a large coarse basket made of twigs of *cytiscus cajan* (*rakar*) or tamarisk (*jhāū*). South of the Ganges we also find डेली *deli*. A smaller basket of the same kind is known as खँची *khānchi* (also खँकी *khānki* in North-East Tirhut), खँचिया *khanchiya*, खचोली *khacholi*, पथुली *pathuli* (Gaya), नोनहारो *nonihāri* (Patna), or (South Bhagalpur) दमहरिया *damhariya*. The डगरा *dagra*, डगरी *dagri*, also called south of the Ganges दौरा *daura*, दौरी *dauri*, or (in South Bhagalpur) डाला *dāla*, is a large shallow basket. These are all made of either bamboo twigs or slips, except the दौरा *daura* or दौरी *dauri* (see above). In Shahabad करु *karū* or डोकी *doki*, and north of the Ganges सिकहती *sikahuti* or सिकौती *sikauti*, is a little basket made of the stalks of the *mūnj* grass.

45. A broken basket is खितनी *chhitni*, or in Gaya खतना *chhatna*, or in South Bhagalpur खितना *chhitna*.* The झँपी *jhampi* or झँपिया *jhampiya* is a little basket with a lid. It is also called पौती *pauti* or पौतिया *pautiya* (being then generally made of *mūnj* grass) and पेटारी *petari* (made of bamboo or rattan). A larger kind is called झँपा *jhāmpa*. The lid of all these is called पेंहानी *pehāni* or झँप *jhāmp*. डेचा *thaicha* or चंगोर *changor*, or in Shahabad डेंचा *thaincha* or ठेंचा *thīncha*, is a kind of large open basket. फुलुडाली *phuldāli* is a flower-basket.

* A common curse amongst Gaya women is खितनी बदनो लागी *chhitni barhni lāgau*,—may your wealth be swept away.

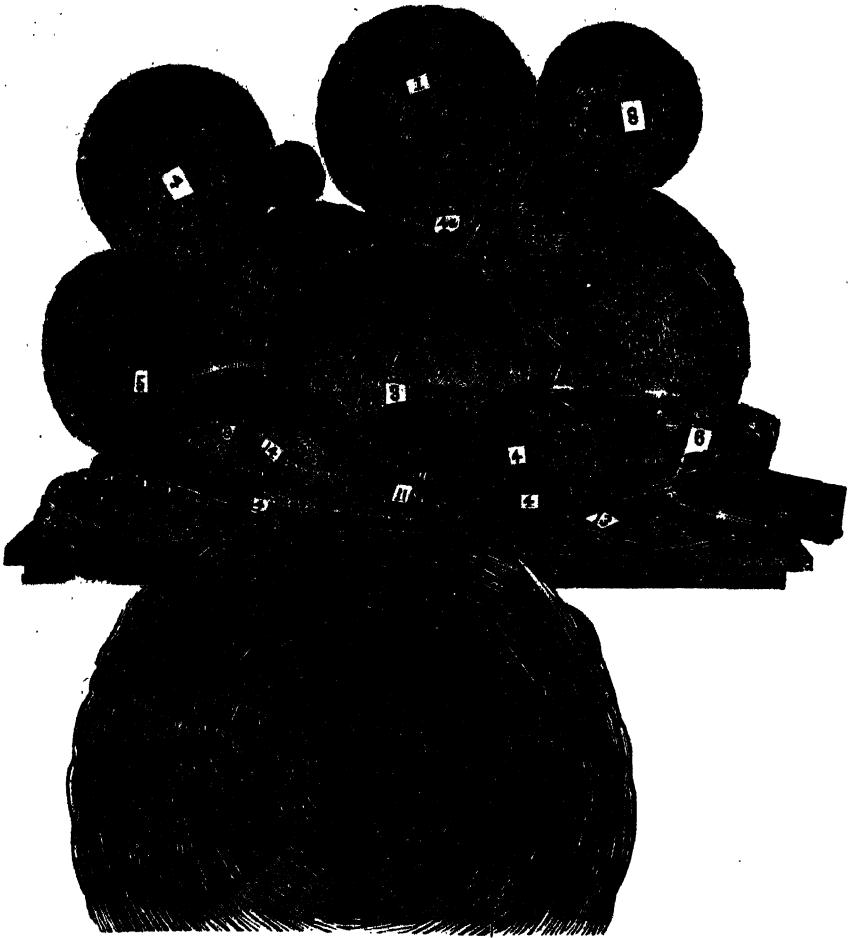

From a photograph.

A Collection of Baskets and of Other Articles of Basket-work.

1. Oriya.
2. Chhaintas of various sizes.
3. Daura.
- 4 & 4a. Dauris of various sizes.
5. Deli.
6. Khaincha.
7. Tāp.
8. Tokri.
9. Dagri.
10. Dagra.
11. Tarāju (scale-pan).
12. Kolsup. } (Winnowing sieves).
13. Sūp. }
14. Chaini (sifting sieves).

MATERIALS.

- Nos. 1 and 8 are made of split bamboo twigs, woven up with the fibre of the leaves of the tāl palm.
- 4a, of the culm of the *sik* grass (*andropogon muricatum*).
- 5 & 6, of tamarisk (jhāū).
- 7, of *rahar* (*cytiscus cajan*).
- 11, of bamboo twigs.
- 13, of *sirki* (the upper joint of *saccharum procerum*).
- The rest are of bamboo slips.

sirhath, and in North-West Tirhut *सरहथ sarhath*. In Champārān it is *खरहरा kharhara*, and in the rest of Tirhut *खर्रा kharra*. South of the Ganges it is, in Gaya and South Munger, *कुचा kuchcha*, in Shahabad *कुंचा kūncha*, and in the south-west of the district *कुंची kunchi* or *सेथन sethan*. In South Bhagalpur it is *जटरी jhatari* or *खरहरा kharhara*.

56. The broom used by grain-parchers for turning the grain which is being parched is *झारु jhāru* in Patna and Gaya, *बरनी barhni* in the south and east generally, *लरना larna* in North-East Tirhut, *चिपनी chhipni* in South-East Tirhut, *चलौनी chalauni* to the west of the North Gangetic tract, and in South-East Bihār *भुजनाठी bhujnāthi*.

57. The long twig broom used for sweeping up leaves and rubbish is north of the Ganges, to the west, *खरहरा kharhara*, and to the east *खर्रा kharra*. South of the Ganges, in South Bhagalpur, it is *खरहरा kharharo*; but in Patna *झाँटा jhānta*, in Gaya *झारु jhāru*, in Shahabad *सिरहथ sirhat* or *झाँकी jhānki*, in the south-west of the same district *झरना jharna*, and in South Munger *झाँटा jhānta* or *जटरी jhatari*.

58. To sweep is in Patna and Gaya *बोहारब bohārab* or *बाहब bārhab*; the former is also used in the south-east. To the west it is *बाहारब bahāral*, and in Tirhut *बाहब bārhab*, *झारब jhārab*, or *झारि झुरि देब jhāri jhuri deb*.

CHAPTER III.—IMPLEMENTS USED IN WEEDING, &c.

59. The *खुरपा khurpa* is a sort of hoe used for loosening the earth round young plants or in weeding.

60. Of this the iron blade is *खुरपा khurpa*, or in North-East Tirhut *पासङ्ग pāsang*. The handle is *बेंट bent*. The iron ring-fastening in the blade is *साम sām* or *सामी sāmi*, and also in Shahabad *चुरिया churiya*, and in the south-west of the district *मुंदरी mundri*. The spike of the blade which goes into the handle is north of the Ganges *नार nār*, and south of it *नार nār* or *दन्ती danti* or (South-West Shahabad) *दाँरी dānri*. Towards the east we find, north of the Ganges, an optional variant *लार lār*, and in South Bhagalpur *लार lāru*.

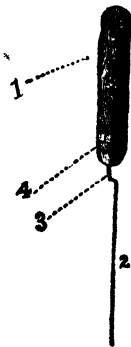

1. Bent (handle).
2. Khurpa or khurpi (blade).
3. Nār or dānri (spike).
4. Sām (ferule).

The Hoe (Khurpa or Khurpi).

61. A smaller instrument for scraping grass or weeding is called,

when the blade is curved, खुरपी *khurpi*, and (south of the Ganges) when it is straight पसनी *pasni*. An optional name for the curved variety in Gaya is बँकुआ *bankua*.

CHAPTER IV.—IMPLEMENTS USED IN CONNECTION WITH IRRIGATION.

62. The beds formed in a field for irrigation are called कियारी *kiyāri*. In South Bhagalpur they are called केचारी *kechāri*. In South Munger गँदारी *ganrāri* are smaller sized beds for the same purpose.

63. These are made with an implement with a handle and board fixed at the bottom, like a rake without teeth. This is worked by a single man, much as a rake is used. In the North-Western Provinces it is usually pulled with a rope, but not so usually in Bihār. It is called generally to the south of the Ganges फरही *pharūhi*, and in East Tirhut फरहा *pharūha*. North of the Ganges, to the west, it is called फहरी *phahuri*. In South Bhagalpur it is called फरुआ *pharua*, and in South Munger फरही *pharhi*. In Gaya it is called पँदनी *penrni*.

64. A wooden shovel used in distributing the water in a field is called हथा *hatha* or हत्था *hattha*. South of the Ganges it is also called आभा *ābha*, in South Bhagalpur चिहा *chhitta*, and in South Munger कठौआ *kathaua*.

65. Other appliances used in connection with irrigation from wells, tanks, or streams will be found in the chapter on irrigation.

SUBDIVISION III.

APPLIANCES USED IN FIELD WATCHING.

CHAPTER I.—THE SLING.

66. This is generally डेहन्वास *dhelmās* or डेहन्वांस *dhelwāns*. In Patna, Gaya, and (optionally) Shahabad it is also called डँहन्वांस *dhenkwāns*. Another name current in Shahabad is डेहुवास *dhekuās*.

In South-East Tirhut it is also called डेहौरी *dholauri*. In South Munger and South Bhagalpur it is दिँदोर *dinror*. सुरदेस *gurdel* to the east, गुलेती *guleti* is a pellet-bow.

CHAPTER II.—THE SCARECROW.

67. This is generally धूह *dhuh*, धूहा *dhuha*, or धुषा *dhua*. In Patna it is पुनखा *putla*, and in Gaya डही *dhahi*.

68. A scarecrow pulled by a string and hung on a tree is north the Ganges डबडबवा *dhabdhabwa*, डकरा *thakra* to the west, डकडकि *dhakdhakiya* in South-West Tirhut, अकासी *akāsi* in South-East Tirhu and elsewhere तारक च्हाजा *tārak chhaja* or धुषा *dhuā*. South of the Ganges it is in South-West Shahabad डमहौषा *damhaua*, elsewhere in the district डमको *damko*. In Patna it is डमकौला *damkau* and in Gaya डलकौषा *dhalkaua*. In South Bhagalpur and South Munger it is डरका or डङका *harka*.

69. Cultivators also usually put an old black earthen pot in field to keep off the evil eye, which is called in Tirhut डोडका *tokk* or in North-East Tirhut तौला *taula*. South of the Ganges we find also डोडका *tokka*, with variants डोडना *totma* (Gaya) and डोट *totwān* (South Bhagalpur). In Shahabad it is called डोना *tona* or नजर गोजर *najar gojar*, and in South Munger नजर गुजर *naji gūjar*. Another general name is करिखार हँड़ी *karikhāi hāuri* or करखादि हँड़िया *karkhāhi hanriya*, from करिखा *karikha* or करक *karkha*, 'soot.' Local variants of this last word are करखी *karkhi* (Shahabad), कारिख *kārikh* (Gaya), and करखो *karkho* (South Bhagalpur). Generally this pot is marked with lime (चूना *chūna*). Thus, a man of A. would say हँड़िया में करिखा लगा के चुन्ना के टीक दे के खेत में धै बावस जाला *hanriya men karikha laga ke chunna ke tik de ke khet men dhai āwal jāla*,—he has come back after setting up in the field the pot on which he has laid soot and marks of lime.

CHAPTER III.—THE WATCHMAN'S PLATFORM.

70. This is known as मचान *machān*, with an optional variant मँच *mānch* in the west.

71. The shed over the platform has various names, viz. north of the Ganges **जोंपन्दी** *jhompri* and **खोंपन्दी** *khompri* generally, **चपन्दी** *chhapri* (North-West Tirhut), **चाही** *chhāhi* (North-East Tirhut), and **लगौरी** *lagauri* (South-East Tirhut). South of the Ganges we have **चपन्दा** *chhapra* to the west and **मरुका** *maruka* and **चपन्दी** *chhapri* to the east.

72. **मरुई** *marai* and also (in East Tirhut) **मरी** *marra*, **गोपिया** *gohiya* (South-West Tirhut) and **पलानी** *palāni*, is a shed on the ground without any platform.

SUBDIVISION IV.

IMPLEMENTS USED IN HARVESTING.

CHAPTER I.—THE SICKLE OR REAPING-HOOK.

These are either toothed or with a sharp cutting edge.

73. (a) *With a sharp cutting edge.*—These are everywhere **हंसुआ** *hansua*. A kind with a heavier blade is called **पघरिया** *paghariya* or **पघरुआ** *pagharua*, or **बधरा** *badhra*, **बधरी** *badhri*, **बधरिया** *badhariya*, or **बधरु** *badhāru*. It is also called in East Tirhut **संगिया** *sangiya*, in South Bhagalpur **दाबा** *dāba*, and in Gaya **चिलोही** *chilohi*.

(b) *With teeth.*—These are called **हंतुला** *dantula*, from **दांत** *dānt*, ‘a tooth.’ They are also called **कैचिया** *kainchiya*, of which **कचिया** *kachiya* is a variant in South-East Bihār.

74. **हंसुली** *hansuli* is a small sickle without teeth, principally used by girls for cutting spinach (**साग** *sāg*), and by toddy-sellers (**पासी** *pāsi*) for cutting palm-trees. The **पहंसुल** *pahsul* is a fixed upright sickle, which is kept in position by the foot resting on the wooden base in which it is fixed, and is used for cutting spinach and other vegetables. In Patna and Gaya, **कट्टा** *kattu* is an instrument used by Doms for cutting bamboos, and **क्योचा** *kyoncha* is an instrument for barking wood.

75. The above names are also used for the curved part of the blade. The straight part of the blade is called **नार** *nār* or (to the east)

कार *lār*. Other names are दान्री *dānri* (South-West Shahabad), नरिया *nariya* (Gaya), and नाब *nāb* (Patna). The handle is बेंड *bent*.

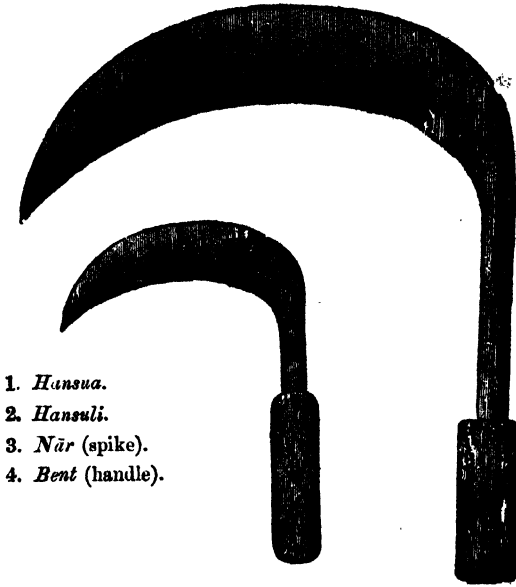

1. *Hansua*.
2. *Hansuli*.
3. *Nār* (spike).
4. *Bent* (handle).

The ordinary Sickle (hansua), and that of the Toddy-seller (hansuli).

CHAPTER II.—RAKES USED ON THE THRESHING-FLOOR.

76. This is खेना *akhaina*. It is a kind of hooked stick used for pushing the sheaves under the bullocks' feet while the grain is being trodden out. This word is only used south of the Ganges. Local variants are खेना *khena* and खेना *akhena* (Patna, Gaya, and South Munger), खेन *akhain* in South-West Shahabad, and खेनो *ukhaino* in South Bhagalpur. When it has five prongs, it is called पचका *pachkha* north of the Ganges, in South Munger, and in Shahabad, and पाँचा *pāncha* also in the last district. This is also called in South Munger पाँचक *pānchakh*.

CHAPTER III.—GRANARIES.

77. These are of four kinds—

1st.—A structure of straw or brushwood in the open air.—These are बहार *bakhār*, बहारी *bakhāri*, or कोठी *kothi*. Local names are बेही *berhi* north of the Ganges generally, ठेक *thek* in South Bhagalpur, and बहारी *badāri* (also in South Bhagalpur) or मुनहार *munhar*

in South-East Tirhut. In Tirhut a गोठी *gohi* is a round कोठी *kothi*; जबर्रा *jabra* in Gaya is a small granary.

2nd.—*Underground pits for storing grain.*—These are everywhere खाद *khād*, and also (south of the Ganges) खाता *khatta* or खाता *khāta*. Local names are चौर *chaur* in South-East Tirhut, माठ *māt* in Gaya, and खाद *khād* or खाता *khāta* in South Bhagalpur.

3rd.—*Granaries inside the house.*—In Sāran डेहरी *dehri* is a small circular closet for holding grain, and is generally made of wattle and mud. The कोठी *kothi*, कोठिया *kothila*, or कोठिली *kothili* is everywhere generally made of sun-baked mud, and is larger.

4th.—*A space surrounded by mats for holding grain* is डेक *thek*. A granary made of straw only is in South Bhagalpur खोंचरी *khonchri*, and in South Munger बाँध *bāndh*.

78. The support of the granary is गोड़ा *gora* generally. Local optional names are बेसना *besna* (South-East Tirhut), बैसक *baisak* (East Tirhut and South Munger), खुरा *khūra* (Patna), and ओटा *ota* (Shahabad).

79. The cover of a कोठी *kothi* is everywhere except in South-East Bihār पेहान *pehān* or पेहना *pehna*. In Sāran and Gaya it also means the plug or stopper (see § 81). Local names are जपना *jhapna* (South Tirhut and South Munger), धपना *dhapna* (East Tirhut and South Bhagalpur), and चाक *chāk* (Patna, Gaya, and South Munger). The opening covered by it is मुँहखड़ *munhkhār* in Sāran. In the same district the cover of a बखारी *bakhāri* is खोंप *khomp*.

80. The bottom is called everywhere पैद *pend*, पैदा *penda*, पैदी *pendi*, or पेनी *peni*. The South Bhagalpur form is, however, पैदो *pendo*.

81. The hole through which the grain is removed is generally आन *ān* or आना *ānā*, local names being आणन *āēn* or मोहखा *mohkhā* in East Tirhut and Patna, and मुँह *munh* north of the Ganges. The plug for filling the hole is दबकन *dabkan*, or in the south-east मुँदन *mūndan*. In Sāran and Gaya it is also पेहान *pehān* (see § 79), and in South Bhagalpur थेपी *thēpi*.

82. A heap of grain is डेरी *dheri* or रास *rās*. In Gaya it is also सिल्ली *silli*. In South Munger a smaller heap is called कुदी *kuddi*.

83. Various earthen vessels are used for holding grain. These are north of the Ganges generally कूड़ा *kūḍā*, माठ *māt*, घैला *ghaila*, or हँडिया *hanriya*. महका *matuka*, खोंच *khonrh*, चेरु *cheru* are also used, but principally to the west. South of the Ganges we have चरुआ *charua*,

खुम *khum*, खोरा *khora*, and मऊकी *matki* in Patna, Gaya, and South Munger (the last two also in Tirhut); खौंड़ *chhorr* in Shahabad, and कूँरी *kūnri* in South Bhagalpur.

84. The covers of these are the same as those mentioned above; the local names are डकना *dhakna* (Shahabad), जकना *jhakna* (East Tirhut and Gaya), and मुन्दन *mundan* (East Tirhut and South Bhagalpur).

85. An earthen cupboard similar in shape to the कोठिली *kothili*, but used for keeping cooking-pots and curd-dishes, &c., is called जबरा *jabra*.

SUBDIVISION V.

IMPLEMENTS AND APPLIANCES USED IN CONNECTION WITH CATTLE.

CHAPTER I.—THE FODDER-CUTTER AND TROUGH.

86. This is गँड़ास *ganrās*, गरँस *garāns*, गँड़ासा *ganrāsa*, or गँड़ासी *ganrāsi*. Local variants are गँड़ासी *ganrsi* in North-West Tirhut and गरँसा *garānsa* in South Tirhut. The word गँड़ासी *ganrāsi* is the usual one. It has a short heavy handle. Other similar implements are दाव *dāv*, टंगारी *tangāri* (Tirhut), and (in Patna, Gaya, and South Munger) काकुट *kakut* or कँकुट *kānkut*. The गँड़ास *ganrās* and गँड़ासा *ganrāsa* are properly heavy implements at the end of a long handle, four or five feet long. They are weapons rather than fodder-cutters.

87. The heavy wooden part immediately over the blade of the fodder-cutter is called जाली *jāli*, जलिया *jaliya*, or मुंगरी *mungri*. Sometimes, especially to the east, it is simply called बेंड *bent*.

88. The blade is गँड़ासी *ganrāsi*, &c., as above. The handle is north of the Ganges मूठ *mūth* or मूठी *mūthi*, and south of it बेंड *bent*.

89. The knob at the end of the handle has various names, viz. एरा *era* north of the Ganges generally, हूर *hūr* in North-East Tirhut, डेकवा *thekwa* in South-West Tirhut and in Shahabad, and आरक *ārhak* in South-West Shahabad. Elsewhere no special name has been noted, unless we include मूठ *mūth* and मुथिया *muthiya* in South-East Bihār.

90. The spiked part of the blade, which goes into the handle, is खुरा *khura* or खुरी *khuri* to the west generally. Also, north of the Ganges, to the west, गोड़ा *gora*, and in North-East Tirhut चोबी *chobhi*.

A very general name is नार *nār* (East Tirhut, Patna, Shahabad, and South Munger), नारी *nāri* (Gaya), or लार *lār* to the east generally.



Fodder-cutter (*ganrāsi*) and block (*theha*).

91. The block on which the fodder is cut.—This is north of the Ganges and in Shahabad ठेहा *theha*. Another name is परिकठ *parikath* (Shahabad and North-East Tirhut), or परिपठ *pariath* (South-East Tirhut and Gaya), परकठो *parkattho* or परैठो *paraitha* (South Bhagalpur), and परकटा *parhata* (South Munger). Other local names are कुठकठना *kutkatna* (Shahabad) and निहुहा *nisuha* (South-West Shahabad).

92. The feeding-trough—When made of earthenware this is नाद *nād* or नाँद *nānd* generally, a local variant being लाद *lād* or लाएद *lāēd* towards the east.

93. In Champaran and North-East Tirhut पथिया *pathiya* is a basket used for the same purpose; elsewhere it is ओइसा *oraisa*. In the same tract a wooden trough for feeding cattle is called नाव *nāv*, a general name for the same being कठरा *kathra*. In Shahabad चरन *charan* or चरनी *charni*, in Gaya गौरी *gauri*, and in South Munger गोंड़ी *gonri*, mean a long feeding-trough of sun-dried mud.

CHAPTER II.—THE MUZZLE AND BLINKERS.

94. The net cattle-muzzle, which is put on them when treading corn and at other times, is जाब *jāb*; local variants being जाबा *jāba* (Gaya) and जाबी *jābi* (East Tirhut, Patna, and South Bhagalpur). North of the Ganges (to the west) जाबी *jābi* means a smaller muzzle, put on calves to prevent them eating earth. Instead of जाब *jāb*, जाडी *jādi* is used in South Munger. मोहरी *mohri* in Shahabad is a rope attached to the head-rope of an animal to prevent it opening its mouth too wide.

95. The conical wooden frame put on a calf to prevent it sucking its mother is डील *dīl*, with for local variants डीला *dīla* (Shahabad

and the east) and *डोहो dhōlo* in South Bhagalpur. In South Bhagalpur another name is *कँडेहो kantelo*.

96. In Patna *दाढा dhātha* is a piece of wood tied round a bullock's mouth to prevent it eating. Elsewhere strings are used, and are called in Tirhut *बेरुवा berua* (west), *काजरी kajārī* or *लगांनी lagāmi* (south-east), *तेना tema*, (north-east), and *जूना jūna* (east generally).

97. *Blinkers* for cattle are in Sāran and Champāsan *अनपट anpat*, and in Tirhut and the south-east *खोलवा kholsa*. To the east generally they are also *खोल khol* or *खोला khola*. In Shahabad they are *चोपनी chhopni* or *नोकना nokta*, in Patna *अंधियारी andhiyāri*, and in Gaya *अंधेली andheli*. In Patna *टोकनी tokni* or *खोला khola* are the blinkers used in oil-presses or sugar-mills. The cloth tied over the blinkers is *अंखमुंदनी ankhmundni*.

CHAPTER III.—THE WHIP AND GOAD.

98. The *whip* used in driving bullocks is *पेना pena* or *पैना paina*. The latter is sometimes spelt *पपना paēna*.

99. Its *lash* is generally *चासुक chābhuk*, with a variant *चसुकी chabhuki* in the north-west. In North-East Tirhut it is *छिटि chhiti*. *साँटा sāntā* is found in South Bhagalpur, and local variants of this are *साटा sāta* in Sāran and South Tirhut and *सटका satkā* in Shahabad. *चरकी chharki* is used in Patna and Gaya, and *जिही jhitti* in South Munger.

100. The *thong* at the end of the lash is *जबू jhabū* in North-West Bihār, *गिरब (the knot)* in North-East Bihār, *फुना phunna* in Gaya, *फिक phik* or *फुदना phudna* in South Bhagalpur, and *फुंदना phundna* in Shahabad.

101. The *spike* at the end of the stick is *आरै arāi*, of which *आरुआ aruuā* is a local variation in Patna and South Munger and *आर ār* or *आरवा arua* in South Bhagalpur.

102. An *elephant-goad* is *अकुस ankus* or *आँकुस ānkus*. A *spear* for driving elephants is *भाहा bhālā*, *बर्चा barchhā*, *बर्ची barchhi*, or (in Shahabad and East Tirhut) *बल्लम ballam*. Another name is *गजनाक gajbāk* or (Patna and Gaya) *गजनाग gajbāg*. The *wooden club* studded with iron spikes, with which an elephant is beaten over the tail, is simply *मुग्दर mugdar*. The *अकुरी akuri* is a *wooden goad* for young elephants, and when made of bamboo it is called (in South-West Tirhut) *कनार kanār*.

103. *दाँग dāng* (East Tirhut and Patna), *डँग deng* (Gaya), and *साँटा sāntā*, are short *sticks* which may be used for driving cattle.

चाङ्गन *chhākun*, चङ्गुनी *chhakuni*, or (South-West Shahabad) चिह्नकन *chhitkan* and (Gaya) पिताुर *pitaur*, are twig whips used for the same purpose.

104. A horse-whip is कोरा or कोड़ा *korā* or चाबक *chābuk*, and a spur कान्ठा *kāntā*.

CHAPTER IV.—HOBBLES FOR CATTLE.

105. These are चान *chhān* or चाँद *chhānd*.* Other local words are पैदा *pairh* or पैदा *pairhā* or (in East Tirhut) पैकर *paikar* or पैकर *paikar* and (in South Bhagalpur) गोड़ानी *gorāni*.

106. A piece of wood tied to the neck of a vicious or runaway animal is ठेकर *thekar* or (to the west) ठकर *thakar*. In South-West Tirhut it is ठोकर *thokar*, and in North-West Tirhut ठोकुरा *thokra*. In Patna it is ठेकरा *thekrā*, and in South Munger ठेकुर *thekur*. North of the Ganges we often find मुंगरा *mungra* or मुंगरी *mungri*, and other local names are दगरन *dagran* (Gaya) and गरहर *garhar* or गरहरा *garharo* in South Bhagalpur.

107. A cattle chain is सिक्कर *sikkar*, सीकर *sikar*, सिक्करा *sikra* or सिक्करी *sikri*. Sometimes these are spelt with a dotted *r*: thus सिक्कर *sikkar*, &c.

CHAPTER V.—ROPES.

108. A. *Those used for cattle.*—The rope for tethering cattle is everywhere पगन्धा *pagha*, and also in South Bhagalpur जोर *zor* or गेंडा *gentha*. In Saran and Gaya it is also तगन्धी *taghi*. The knots or loops by which they are tied are जोर *zor* or ठेका *theka*.

109. In Gaya and the south-east सेली *seli* is a hair string tied from the neck to the feet of a calf when milking a cow. In Gaya it is also called सेल *sel*.

110. A tethering-rope, by which cattle are tied to a peg, is चान *chhān* generally, or (locally) गूहा *gūrha* (North-West Tirhut, Gaya, and Shahabad), गोड़ान *gorān* (South-West Shuhabad), गोड़ार *gorār* (Patna and Gaya), गोड़ान *gorāwan* (Gaya and South Munger), देहौराजोर *derhaurāzor* (Gaya and North-West Tirhut), मलौ *malau* (South-East Tirhut), जोर *zor* (Champāran and North-East Tirhut), and जोरो *zoro* or गोड़ानी *gorāni* (South Bhagalpur). Most of these

* As in the proverb गद्दा गेंडा सरग, चान लगले गेंडेदि *gadha gelāh sarag, chhān lagle gelainhi*,—the donkey went to heaven and took his hobble with him; i.e., vices follow one to a future life.

refer rather to the kind of knot or loop with which they are tied than to the rope itself.

111. A double tether for wild cattle, held by two men round the animal's neck, is north of the Ganges **दोबगगी** *dobaggi*, or in South-East Tirhut **दोगहा** *dogahā*, in North-East Tirhut **दोबगली** *dobagli*, in North Bhagalpur **दोबगी** *dobagi*, and in Saran **दुबगली** *dubagli*. South of the Ganges **चरकी** *chharki* is used in Gaya and Munger in the sense of this method of attaching ropes. It is also used for the mode in which a log is attached to an animal's neck.

112. **नाथ** *nāth* is a head-rope for cattle, passing through the animal's nose.

113. **अगाड़** (or **अगार**) *agār* or **अगाड़ी** (or **अगारी**) *agāri* is a head-rope for horses, a local name being **गखणोर** *galkhor* in Gaya and Shahabad. **पिछाड़ी** (or **पिछारी**) *pichhāri* is the heel-rope, which is also called (north of the Ganges) **पछाड़** *pachhār*. **बागन्दोर** *bāgdor* or **बगन्दोर** *bagdor* is a rope for tying horses. **तान** *tānt* or **मोजमा** *mojamma* is the thin leather rope tied round the horse's hocks. The halter tied round a horse's neck is **गरौनधन** *garaundhan* or **गरन्दाँव** *gardānw*, or (in Shahabad) **गर औनधा** *gar aundha*, and (in North-East Tirhut) **गरन्दन** *gardam*.

114. To the west and north **पैकर** *paikar*, **पैकर** *painkar*, or **पैकरा** *paikra* is a heel-chain for a camel, while to the south-east it is used for elephants. It is also used by travelling merchants for cattle. **नकैल** *nakail*, **नकेल** *nakel*, or in Saran **नकःखोल** *naklol*, is the nose-rope of a camel.

115. *B. Ordinary ropes.*—An ordinary rope is **रस्सी** *rassi*, **रसरी** *rasri*, **डोर** *dor*, **डोरी** *dori*, or **जँवर** *jemuar*. **जोर** *zor* is also used, and (in Tirhut, Patna, and Gaya) **जौरी** *jauri*.* **रस्सा** *rassa* is a cable. A ship's cable is **लहासी** *lahāsi*, or in Saran **लहास** *lahās*; and a tow-rope, **गून** *gūn* or (in Gaya and the south-west) **गोन** *gon*. **गैता** *gainta* in Gaya is a rope for carrying beams. A coil of rope in the same district and in Champāran is **घुरचौला** *ghurchīla*. For the ropes used by a **पासी** *pāsi* or toddy-seller, see § 375. The string used in drawing water from a well with a brass vessel (**छोटा** *lota*, &c.) is called **डोरी** *dori*; while the general name with other vessels is **उबहन** *ubhan*, **उबहनी** *ubhani*, or (in South Bhagalpur) **उबहैन** *ubhain*, and in North-East Tirhut **उबहन** *ughen*. The knot round the neck of the vessel is north of the Ganges and in Shahabad **अरवन** *arwan*, and in Patna, South Munger, and South-East

* As in the proverb **जौरी जरि गेल, रैठन ठामे जौरीजारी गेल, अन्तन थामे**,—the rope may be burnt, but the strands remain (even though reduced to ashes); i.e., a rich man come down in the world retains his pride.

Tirhut रौना *rauna*. Other local names are फणकी *phankei* (North-East Tirhut), फँदनी *phandni* (Gaya), फॉस *phāns* (East Tirhut and South Bhagalpur), and फँसरगाही *phansargāhi* in Gaya and South Munger. A small piece of rope attached to the vessel and then tied on to the regular well-rope is generally पन्धोर *panchhor*. A local name is छोरी *chhori* (Champāran and South-East Tirhut). Its knot is मुन्धी *mundhi* in Tirhut and the north-west, and मुद्दी *muddhi* in Shahabad. A thick well-rope is रसा *rassa* or बरसा *barha*.

116. The rope which is used in working the irrigation lever (लाठा *lātha*, &c.) is बरसा *barha*, with an optional variant बरह *barah* in South Munger. Other names are हथबरही *hathbarhi*, and in Champāran and North-East Tirhut उबहनि *ubahani*. The short rope joining it and the bucket by a slip-knot is पन्धोर *panchhor* or छोरी *chhori* everywhere, with the following local names:—छोर *chhor* (South-West Shahabad), जोता *jota* (Saran, Patna, and Gaya and the south-east), जोती *joti* (Shahabad and South Munger), नाधा *nādha* (optionally in Gaya), नधान *nadhān* (optionally in Saran), and बगसा *bagha* (South Bhagalpur).

117. The strings used in working the irrigation swing baskets (चाँड़ *chānr*, &c.) are known as डोर *dor* or छोरी *dori*. In Saran they are जोती *joti*.

118. The ropes used for dragging a harrow are north of the Ganges generally हंगही *hengahi* or बरही *barhi*, &c., as described in § 33.

119. To the west मोजर *mojar* or मोजरी *mojri* is a rope put round the roots of young trees to hold up the earth as they are being transplanted, other names (in South-West Tirhut) being गेरसा *gerusa* or (also in Champāran) बन्धना *bandhna*. In West Shahabad and Gaya it is गुर्ही *gurhi*, and in South Bhagalpur जर्बन्धना *jarbandhna*.

120. The generic term for a grass rope is जुना *juna* or जूना *jūna*, and in Patna and Gaya also जौरी *jauri*, and in Champāran पन्धर *panthar*. It is used for tying up bundles and for cleaning vessels. Another name in Tirhut is सरपत *sarpat*. गतान *gatān*, or in Shahabad गत *gāt*, is a straw rope for tying up bundles. Ropes for tying up bundles of sugar-cane are जोती *joti*, उखबन्धना *ukhbandhna*, गतौरा *gataura* (South-West Shahabad), and पंगार *pangar* (North-East Tirhut) or पगड़ा *pagra* (made of sugar-cane leaves in South Bhagalpur). गुर्ही *gurhi* in Shahabad and north of the Ganges, to the east generally कचरा *kachra*, and in East Tirhut ओदार *odār*, is a loosely-twisted hemp rope (but गुर्ही *gurhi* may be either straw or hemp) for tying up bundles of crops.

121. A rope made of the stems of the *cytiscus cajan* (*rahar*) and similar plants for tying up bundles is called बँती *benti* in Patna, Gaya, and South Munger, and बँतगँदी *bentri* in South Bhagalpur. In Gaya it is also called बँधेरी *bandheri*. जुनेरी *juneri* (Gaya) is a similar rope made of *kus* grass. Ropes made of thatching-grass are called north of the Ganges झालास *jhalās* or झालगँदी *jhalsi*. Bundles of *mūnj* grass twisted up for cleaning vessels are लूँडा *lūnra* or नूँडा *nūnra*. A thick hemp rope is बरगडा *barha*, बरगडी *barhi*, or (in Gaya and South Munger) बरगडा *barta* or बरगती *barti*.

122. For most of the above the word जूना *junā* or (when the rope is made of straw) गतान *gatān* may be used, or a periphrasis may be used, e.g. कुसक रसरी *kusak rasri* for जुनेरी *juneri*.

123. सूत *sūt*, सूता *sūta*, or तागा *tāga*, is ordinary thread for sewing and weaving. सुतरी *sutrī* or (rarely and only in the extreme west) सुतगँदी *sutti* is twine. This in South Bhagalpur is called सुतगरी *sutkri*. Twisted string is south of the Ganges ठररा *tharra*. North of the Ganges and in South Munger बाँटल रस्सी *bāntal rassi*, पैंठल रस्सी *ainthal rassi*, or (to the west) बारल रस्सी *baral rassi*, is used.

124. To the west चोप *chop* is string made of the bark of the *butea frondosa* (परास *parās*) or of the palm-tree. In Gaya it is called चोप *chomp*.

CHAPTER VI.—PADS FOR CATTLE.

125. These are known generally as गद्दी *gaddi* or पलान *palān*. In Patna, Gaya, and Shahabad बखरा *bakhra* is a leather sheet which goes over this. A खरहिवा *kharahiya*, or in Saran खरेवा *kharaiya*, is a pad stuffed with खर *khar*, and under it is placed the कन्हेली *kanheli*. पेटार *petār* is in South-West Shahabad a belt for tying them, and पचोली *pachholi* a rope fastened to the animal's tail for the same purpose.

126. The pad for an ass is लेवा *leva*, local names being पिठिया *pithiya* (Tirhut) and सुरका *surka* (also in East Tirhut) or तरगडी *tarchhi* (Shahabad). In North-East Tirhut and Gaya चहौनी *chhalauni* is the cover of the pad. That of a bullock is (besides गद्दी *gaddi* and पलान *palān*) north of the Ganges and in South Munger कन्हेली *kanheli*, and south of it, to the west, चहाबखरा *chhallābakhra*, and to the east चहा *chhalla*.

127. An elephant's pad is गद्दी *gaddi*, and in Shahabad also गद्दा *gudda*. Underneath is placed a softer one called गद्देवा *gadela*.

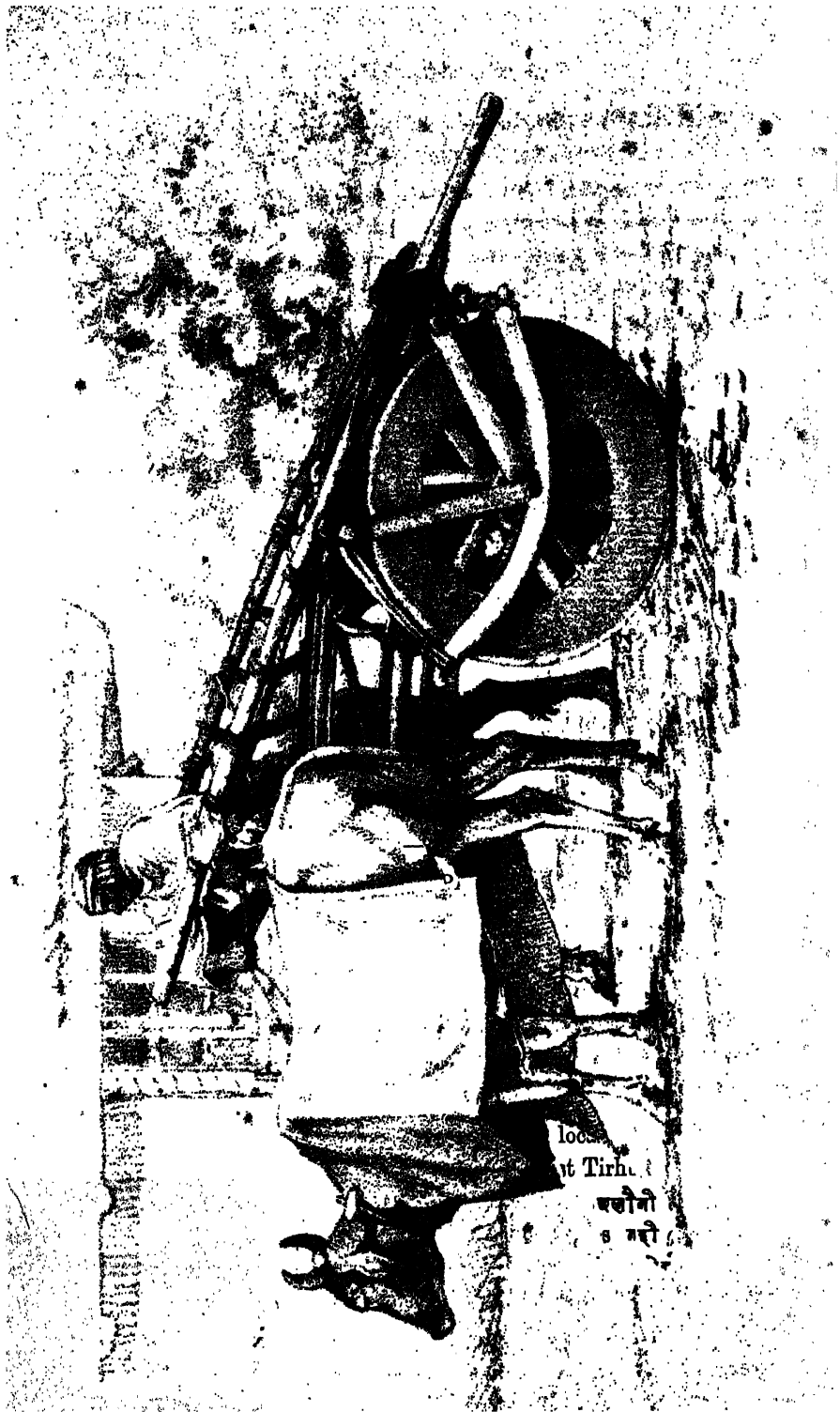

loc
at Tirh
बलौनी
स गरी

CHAPTER VII.—GRAIN-BAGS AND PANIERS FOR LOADED CATTLE.

128. These are बाघा *ākha*, बाँघा *ānkha*, or तङ्गी *tangi*;* south of the Ganges they are also गेठिया *gethiya* or पट्टा *patta*. In Shahabad, however, they are जोरा *jora* or गोन *gon*.* A large grain-bag carried on a bullock's back is in Saran लदौरी *ladauri*, or (also in North-West Tirhut) लगौरी *lagauri*. In Gaya this latter word means the cord by which the bag is fastened on the animal's back.

129. खुरजी *khurji* is a gunny (तट *tāt*) bag borne by asses and used by potters for bringing clay from earthpits (मटिकान *matikhān*), and by others for carrying bricks, &c.

130. A rice-sack is बोर *bora* or तङ्गी *tangi*.

131. In South Bhagalpur a bag borne by the bullock, in which the drivers put their luggage, is कटारी *katāri*, and in South Munger it is हँदुवाच *hanrwāy*. In Saran it is खाच *khās*.

CHAPTER VIII.—CANVAS, LEATHER, OR TARPAULIN COVERS.

132. These are तिरपाच *tirpāl* or (when made of चाच *chhāl*, leather) चला *challā*.

133. झूल *jhūl* or जोली *jhōli* is a body-cloth put over bullocks in cold weather. In Gaya it is also जोला *jhōla*, and in Saran ओहना *orhna*. झूल *jhūl* also means an embroidered cloth spread over an elephant's pad.

CHAPTER IX.—VESSELS FROM WHICH ANIMALS ARE FED.

134. The bag from which cattle are fed is जोली *jhōli*, or in Champaran जोला *jhōla*. A horse's grain-bag is तोपडा *tobra*. In Patna कपार *kapāi* is a [redacted] bag for cattle.

135. Feed[redacted] is described in §§ 92, 93.

CHAPTER X.—DAIRY UTENSILS.

136. *The milkpail.*—This has various names, according to locality. North of the Ganges generally they are जभही *jabhi* or दुदही

* As in the proverb बैल न० कूदे, कूदे तपी *bail na kūde, kūde tangi*,—a bullock does not leap, but his load does, of which the Shahabad version is बैल न० कूदे कूदे गोन, ई तमाचा देखे कोन *bail na kūde, kūde gon, i tāmāsa dekhe kon*.

कँडिया *dudahi kantiya*; but they are also भाँड़ा *bhānra* in Champāran, घुरला *ghurla* in the North-West generally, and चपरी *chapari* in North-East Tirhut. South of the Ganges we have टहरी *tahri* or पूरा *pūra* in South-West Shahabad, and कँडिया *kantiya* in the rest of the district and East Bihār; चाँपी *chāmpi*, टेहरी *tehri*, or पतला *patla* in Patna and Gaya; दुहनी *duhni*, चुकी *chukki*, कडिया *katiya*, मडिया *metiya*, कठली *kathli*, or कठरी *kathari* in South Bhagalpur; and चुकरी *chukri* or चुका *chukka* in East Tirhut and South Munger.

137. दाबा *dāba*, दबही *dabhi* (also in Champāran), पाथा *pātha*, रास *rās*, or रासि *rāsi*, are large milkpails used in North Tirhut, and थपरी *thapri* is a smaller one. काँरी *kānri* or कठरी *kathari*, also in North-East Tirhut कड़ा *kattha*, are in Tirhut wooden milkpails. In South Munger रास *rās* is used instead of रास *rās*.

138. *Vessels used in making and keeping clarified butter (घृ ghyā, &c.) and curds (दही dahi, &c.).*—This also has various names, viz. north of the Ganges दहियाही चाँड़ी *dahiyāhi hānri* or काराही *karāhi*. A local name is करना *karna* (Champāran and Tirhut) or कौरना *kaurna* in North-East Tirhut. South of the Ganges we meet भाँड़ा *bhānra* generally, with a variant भाँड़ *bhānra* in South Bhagalpur and दहेँरी *dahenri* to the west. In Patna and Gaya we have चम्पा *champa*, महाड़ा *mahāra*, and नदिया *nadiya*. The last is also used north of the Ganges and in South Munger. In South Bhagalpur other names are कान्त्री *kantri* and चाँह *chhānchh*.

139. There are sometimes special names for special sizes. Thus while चाँड़ी *hanri* or कँडिया *hanriya* is everywhere used for the larger size, the next smaller size is in Tirhut कोरा *koha* or करना *karuna*. कोरा *koha* is also used in South Munger, and पतिला *patila* or पतुकी *patuki* is used with the same meaning in Saran. The next smaller size is कोरी *kohi* or कवतरी *kahtari*. A still smaller size is चाँही *chhānchhi*, टमकुरी *matkuri* (of earth always) or मटकुरी *matkūri* (North-West Tirhut), and the smallest size of all is कँडिया *chhānchhiya* or नदिया *nadiya*.

140. The vessel for holding clarified butter is विवही भाँड़ा *ghiwahi bhānra*, कँडिया *kantiya*, कोही *kohi*, रास *rās* (large), चुका *chukka* (small), &c. Other names in North-East Tirhut are विवक कड़ना *ghiwak karha* (large) or विवक कड़री *ghiwak karhi* (small). In Patna, Gaya, and South Munger चम्पा *champa* or चाँपी *chāmpi* are used, and रसोली *rasoli* (large) and फेरुआ *pherua* (small) are met in South Bhagalpur.

141. The leather vessel in which it is exported is कूप्या *kuppa* or कूपी *kuppi*. The latter is smaller than the former, and is also used for

holding oil. In North-East Tirhut it is also called चमड़ी *chamri* or चौकड़ी *chaukthi*. नदौर *nadoi* is used in Gaya, and गेहा *gelha* is a similar smaller vessel.

142. *The churn.*—To churn is मचल *mahal* to the west and मचव *mahab* to the south and east. The act of churning is महार *mahāi* or महार *mathāi*; local variants being मही *mahi* in Champāran and South Bhagalpur, and महार *mathai* or महन *mahan* there and in Gaya and South Munger.

143. A churn is north of the Ganges, to the west, मत्तमहनी *matmahni*. In Tirhut and Gaya it is कुँडा *kūṇḍa* or (south-east and also in Gaya and Champāran) कुण्डा *kunda*, and (north-east) खोर *khōr*. South of the Ganges it is कमारी *kumāri* in South-West Shahabad, तौला *taula* in the rest of the district (also in East Tirhut), घोरमाहा *ghormāha* north of the Ganges and in Patna and Gaya, and महॉडा *mahāṇḍa* in South Munger.

144. The stirrer or stick moved in the churn is रही *rahi* generally, and also महनी *mahni* to the west and in Tirhut. The latter has local variants, viz. महनी *mathni* (Tirhut and the West), महान *mahān* (West), and महॉनी *mahonni* (Gaya). Local names are गजही *gajhi* (South-East Tirhut), छोड़ी *chhorhi* (South-West Shahabad and East Tirhut), and घोराठी *ghorāthi* (Patna, Gaya, and South Munger).

145. The rope with which it is twisted is generally रसरी *rasri* or डोरी *dori*; but more specific names are नेत *net* (generally), with local variants नेवत *newat* or नेवता *newta* (east) and नेतो *neto* (South Bhagalpur). In Patna it is खिचनी *khinchni*, and in South Munger दम *dam*. Another name in South Bhagalpur is जोती *joti*.

146. *Various vessels.*—In South Bhagalpur काई *kāin* is a small vessel containing a quarter of a *ser* of milk. A पाथा *pātha* contains one *ser*, and a चुका *chūka* four *ser*. In Sāran a चुका *chukka* contains a quarter of a *ser*.

SUBDIVISION VI.

APPLIANCES USED IN THE CONVEYANCE OF GOODS OR PASSENGERS.

CHAPTER I.—THE COUNTRY CART.

147. The ordinary cart is called everywhere गाड़ी *gāri*, but in Sāran it is more usually गड़ी *gari*. The चक्रा *chakra* or

गाड़ा *gāra* is the large complete full-sized cart, with long bamboo poles projecting from each side in front. In North-East Tirhut it is sometimes called चघूस गाड़ी *chaghūs gāri*. The सगगर *saggār* or सागगर *sāgar* is a lighter and rougher kind of cart for carrying country produce. In Gaya and Shahabad it is also called लरहिया *larhiya*.

148. For carrying passengers the रथ *rath* or रन्थ *ranth* is a light four-wheeled cart used by rich people. A similar two-wheeled cart is called सौंगी गाड़ी *sāmugi gāri* or (in Gaya) सौंगी गाड़ी *saungi gāri*. It is also called मण्जोली *manjholi* in Tirhut and Gaya and बहल *bahal* generally, with variants बहेली *baheli* (Patna and Gaya) and बहली *bahli* (Gaya). The प्रका *ekka* is a two-wheeled light trap, generally drawn by a pony. In Sāran it is also called घोड़ बहल *ghor bahal*. The किराँची *kirānchi* is a covered cart something like an omnibus on two wheels.

149. A cart drawn by a single pair of bullocks is दोबरदा *dobarda* or दोकरदा *dokra*. One drawn by two pairs is चौबरदा *chaubarda* (but this hardly ever occurs). In a team of three bullocks the wheelers are called धुरी *dhuri* or धुरिया *dhuriya* to the west and जोड़ी *jori* to the east, and the leader बौड़ *binr* or बिड़िया *binriya* to the west and जिह्ठी *jhitti* (also in Sāran) or नाटा *nāta* to the east.

CHAPTER II.—THE LARGE COMPLETE COUNTRY CART.

150. This is चक्रदा *chhakra*, गाड़ा *gāra*, or चघूस गाड़ी *chaghūs gāri* (see Chapter I). Its parts are as follows:—

151. *The wheel.*—This is everywhere पहिया *pahiya*. To the west, and also in Gaya and South-East Tirhut, it is also called चक्का *chakka*.

152. *The felloe* is called मङ्गर *mangar*, except in Gaya, where it is जमोड *jamot*. It is made of six segments of sisu wood, called each पुठी *putthi*.

153. *The nave* is called नाच *nah*. In Gaya it is also नाच *nah*, and in Sāran नाचा *nāha*. Through this the spokes run completely through and through, each spoke terminating at each end in the felloe, each thus forming in reality two spokes. There are six of these double spokes altogether, making three pairs of two parallel spokes each (see illustration). These three pairs are of varying thickness. The first pair driven in is thicker and stronger than the second pair,

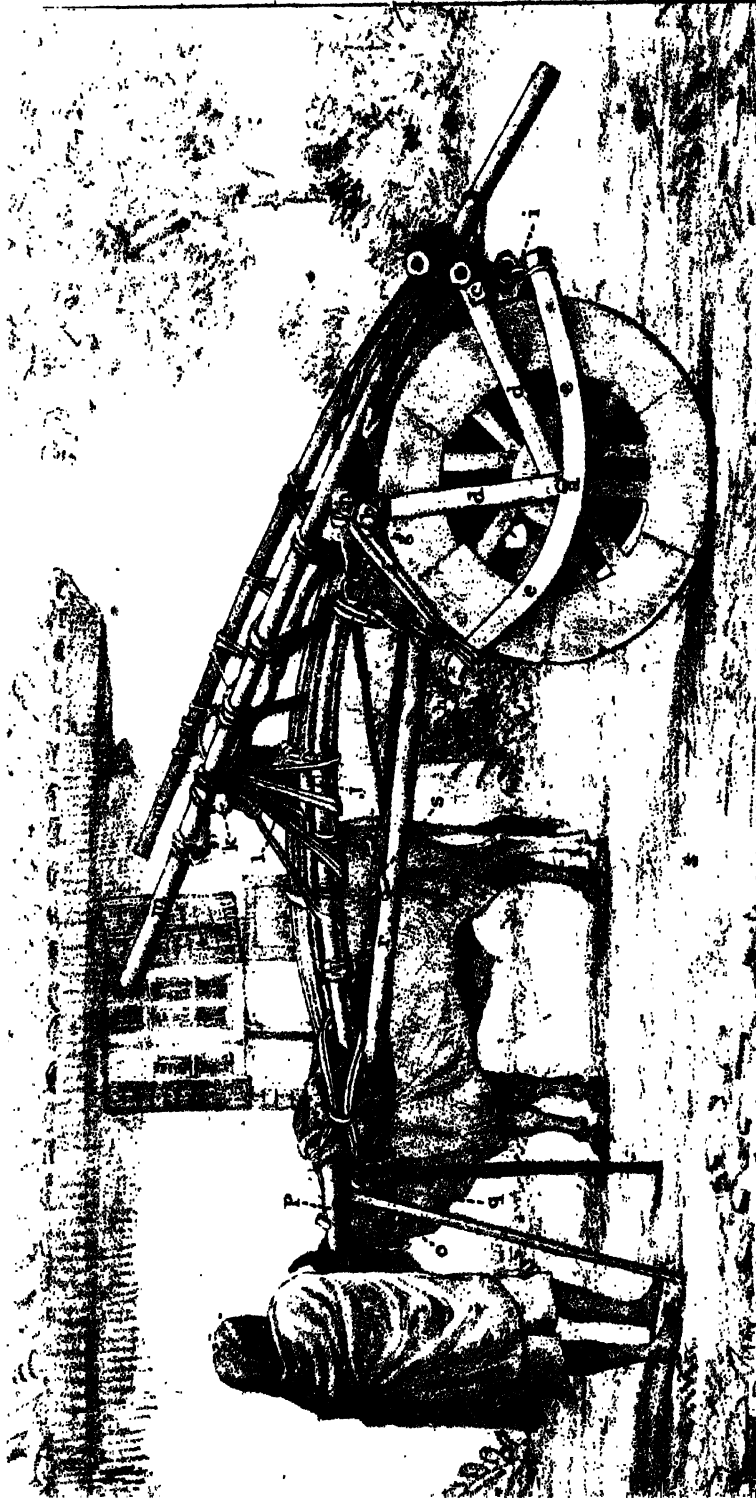

a = projecting end of the axle.
 b = end of takau.
 c = end of ak.
 d = the tulawas

e = the pamjani.
 f = the janis
 g = the karis
 h = the amerhi.

i = the kulangra.
 j = the pirhiya.
 k = the tj.
 l = the khuntri.

m = the balls.
 n = the bilaiya.
 o = the segun.
 p = the munhthopra.

q = the utra.
 r = the laypa.
 s = the jastika

By Begun Bahery Das, Student Govt. School of Art Calcutta.

A full-sized Bullock-cart (Chhokra). side view

and the second pair than the third pair. In crossing each other in the nave, the second pair runs through the first pair, and the third pair through the second and first. These pairs have names, viz.—

154. *The spokes.*—1.—The first pair is called **आरा** *āra*. This is the thickest and strongest pair of spokes in the wheel.
- 2.—The second thickest and second strongest pair of spokes is called **निमारा** *nimāra*, other names being **बेलि** or **बेली** *beli* (Tirhut and South Bhagalpur), **नीम धूरी** *nīm dhūri* or **नेवारा** *nevāra* (South-East Tirhut), and **लेवारा** *lewāra* (Shahabad).
- 3.—The weakest and thinnest pair of spokes in a wheel is called **गज** *gaj*.

To the west and in Gaya, both the second and third pairs are called **गज** *gaj*. The spokes are collectively called **डंड़िया** *danriya*, and to the west also **आरागज** *ārāgaj*.

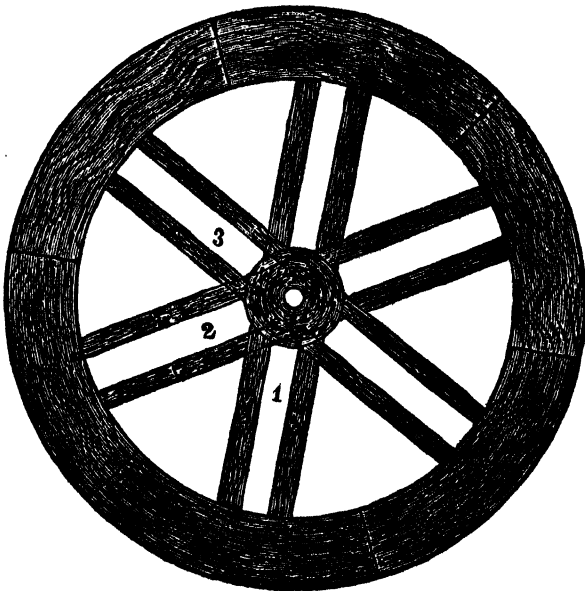

1. *Āra.*
2. *Nimāra.*
3. *Gaj.*

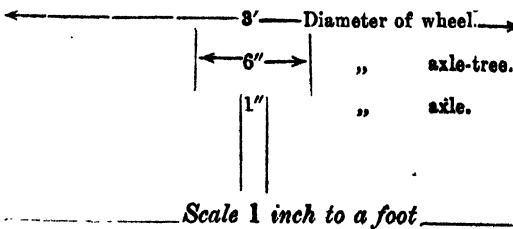



FULL SIZED BULLOCK CART (CHHAKRA) - BACK VIEW.

165. The outside washer of hemp (एन *san*) is चेनी *cheni*, चँदी *chendi*, or (in Sāran) चेन्ही *chenhi*. That inside the wheel is खानन *khānan*, with variants खनन *khanan* (Sāran), खनखन *khanhan* (South-East Tirhut), खँगन *khāngan* (South-West Shahabad), and खँदन *khāndan* (South Munger, Patna, and Gaya).

166. *The axle.*—Each wheel has an axle of its own, each supported entirely by struts descending on each side of the wheel from the side of the cart to which the wheel belongs. The axle is धूरा *dhūra* or धूरी *dhūri*. Sometimes a distinction is made, धूरा *dhūra* being used when the axle is of wood and धूरी *dhūri* when it is of iron; but this is by no means universal.

167. *The outside supports of the axle.*—The supports outside the wheel are two pieces of wood meeting outside the wheel in front of the nave, where, at the point of crossing, they receive the axle. The upper end of one fits into one end of the front crossbar of the frame of the body of the cart (टेकानी *tekāni*, &c.), and that of the other into one end of the rear crossbar of the frame of the body of the cart (आक *āk*, &c.) (see illustration). These supports are called तुलावा *tulāwa*. They are fastened to the body of the cart by chains or ropes, called बान *bān* or बन्द *band*.

168. The curved branch of *sisu* wood which passes under the point of the axle, where it projects from the तुलावा *tulāwa*, and thus further supports the axle, is called पँजनी *painjani*, with variants पँजनी *panjani* (Shahabad optionally) and पँगनी *pengni* (North-East Tirhut). In Gaya it is called दाब *dāb*. It is pulled tightly up against the axle by three ties, two in front and one behind.

169. The front ties fastened to the fore end of the पँजनी *painjani* are called जन्त *jant*. The other end of each of these ropes is fastened to a hook, called कड़ी *kari*. One of these hooks is fastened to the टेकानी *tekani*, and the other to the bottom of the cart, farther on in front, to one of the कड़कड़ी *karhari* (*vide post*). The जन्त *jant* are tightened by a stick called अमेही *amerhi*, or in Sāran सलैया *saluiya*, which passes between them and twists them together to the requisite degree of tightness.

170. The rear tie of the पँजनी *painjani* is called कुलंगड़ा *kulangra*, or in Sāran तुलंगड़ा *tulangra*. It generally consists of one iron chain. Two rings (खर्कहिया *kharkhariya*) hang in two staples (कोँदा *konrha*) to the underside (पराक *parāk*) of the rear bar (आक *āk*) of the cart. One of these rings hangs near the centre of the आक *āk*, and the other

at the end near the wheel. The chain is fastened to one, then passes round the end of the पेंजनी *painjani*, and the other end is fastened to the other ring. In this way the पेंजनी *painjani* is held in its place. The accompanying sketch will make this clear.

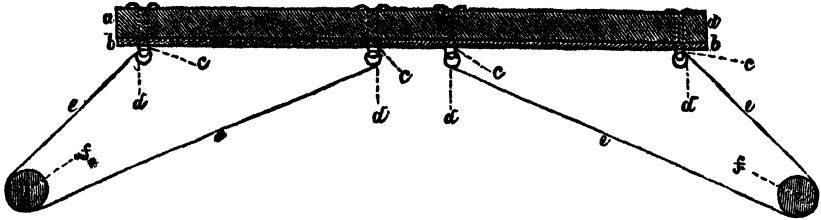

a-a = the <i>āk</i> .	d = the <i>kharkhariya</i> .
b-b = the <i>parāk</i> .	e = the <i>kulangra</i> .
c = the <i>konra</i> .	f = the rear end of the <i>painjani</i> .

171. The *body of the cart* may roughly be described as a long triangle strongly built, lying on one surface, and arched so that its convex side is uppermost. Viewed from the side it resembles a shallow arch, and from above a triangle. Across the back a strong square or oblong frame is laid. This serves as the foundation for the carrying portion of the cart. The annexed illustration is a plan of a cart taken from above.

172. The चक्र *āk* or चाग *āg* is the *main beam in the rear* of the cart. It is made of *sisu*. In Shahabad this is called चाँच *ānkh*. Another and lighter piece of wood going underneath the चक्र *āk* to strengthen it, and also made of *sisu*, is called पड़ाक *parāk*. A slip of bamboo tied on behind the चक्र *āk* and forming the tail of the cart is known as पचलकड़ा *pachhlakra*, with local variants, viz. पंचलकड़ा *panchlakra* in West Tirhut, पिचलकड़ा *pichhalkara* in Patna and Gaya, and पिचलकड़ा *pichhlakra* or कड़ा *kara* in Shahabad. In South Bhagalpur it is अँकोर *ankora* or पचहना *pachherna*.

173. The *front bar* of the square portion of the cart is known as डेकानी *tekāni*. In South Munger it is तेकानी *tekāni* with a dental *t*.

174. The *sides* of the square part of the body, going over the wheels and joined at one end to the चक्र *āk* and at the other end fitting on to the top of the डेकानी *tekāni*, are called धुरौटी *dhurauti*.

175. The piece of wood fitting over the end of each of the धुरौटी *dhurauti*, where it joins the डेकानी *tekāni*, and holding the former in its place, is called बिसेया *bilaiya*.

- a-a = the *āk*.
- b-b = the *pachhlakra*.
- c = the *tekāni*.
- d, d = the *dhurauti*.
- e, e = the *bilaiya*.
- f = the *pirhiya*.
- g = the *sagūn*.

- h = the *phar*.
- i, i, i = the *karhari*.
- j, j, j = the 18 *batti*.
- k = the *pachhua*.
- l-l = the *tij*.
- m, m = the tops of the two *khuntri*.
- n = the *munhthapra*.

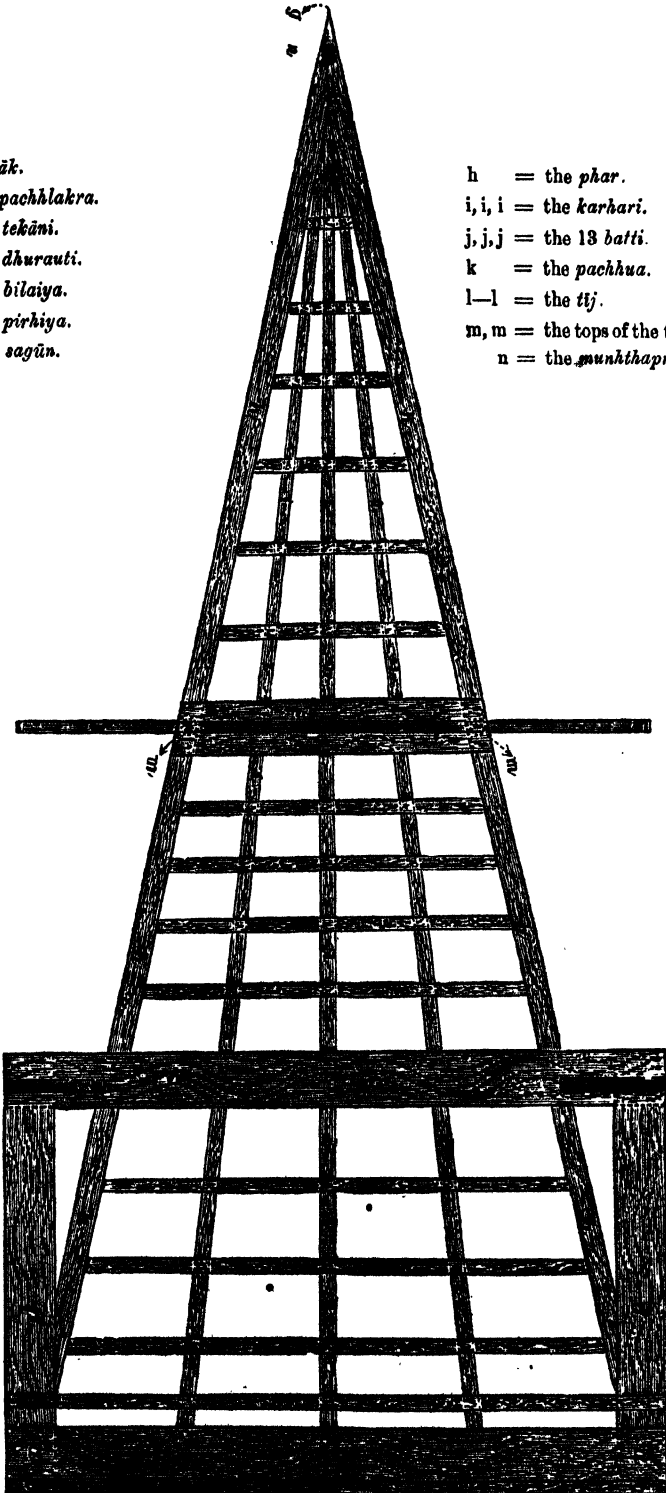

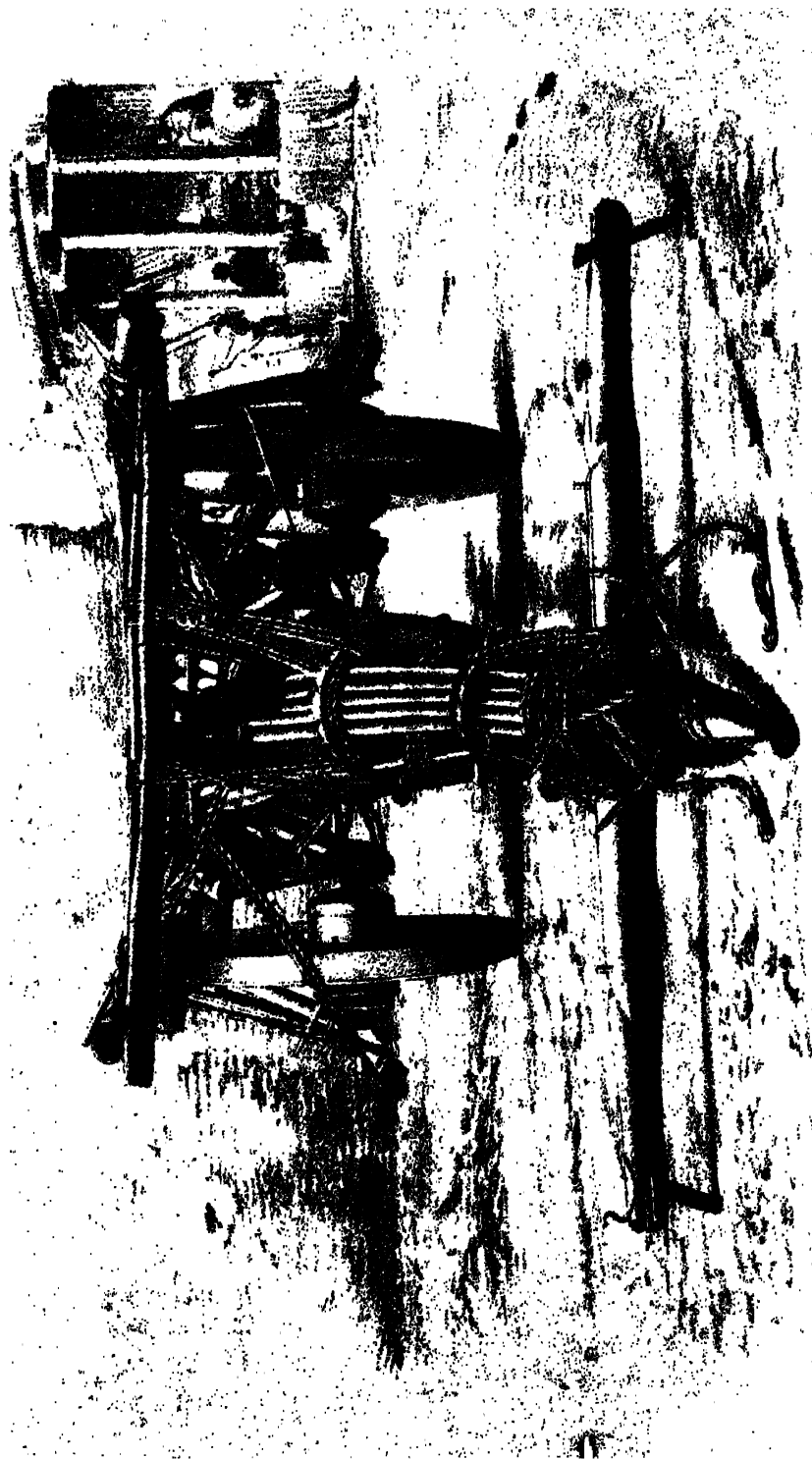

FULL SIZED RHYLOCK CART (CHHAKRA)—FRONT VIEW

176. The short stout *cross-bar* of *sisu* wood crossing the triangular body of the cart between the डेकानी *tekāni* and the apex of the triangle, in front of the driver's seat, is called पिदिषा *pirhiya*.

177. The *point* which is the front of the cart, and which forms the apex of the triangle, is called सगुन *sagūn*, or in Patna and Gaya सगुनी *guni*. The lower portion of this is called in Sāran चोप *thop*.

178. The two long *sides* of the cart, forming the sides of the triangle, starting one from each end of the चाक *āk* and meeting in the सगुन *sagūn*, are known as फर or फड़ *phar*, a local variant being फेड़ *phair* (North-East Tirhut). They are also called तंगा *tānga* south of the Ganges and हारसा *harsa* in Sāran and Champaran. They are sometimes strengthened with a band of iron, called पत्तर *pattar*, बन्द *band*, or बन्द *band*.

179. The whole *bottom* of the cart is called चल्जा *chhajja*. It is composed of the फर *phar*, the चाक *āk*, the डेकानी *tekāni*, and the पिदिषा *pirhiya*, and has in addition three long strips running the length of the cart, called कड़ुहड़ी *karhari*, and thirteen cross-pieces called बत्ती *batti*, or in Sāran बत्ता *batta*, and in Gaya also चाही *chāli*. The कड़ुहड़ी *karhari* are also called फरी *phari* in Patna and the south-west and चपोट *chapot* in Shahabad. North of the Ganges they are also called मन्जा *mānjha*, मँजा *mānjha*, or भरानी *bharāni*. They are fastened in their places by pegs, called फरगिजा *pharkilla*, कठगिजी *kathkilli*, or किजी *killi*, पुर *pachchar* (&c.), or काँटी *kānti*. Of the thirteen बत्ती *batti* or cross-pieces, there are three between the चाक *āk* and the डेकानी *tekāni*, four between the डेकानी *tekāni* and the पिदिषा *pirhiya*, and six between the पिदिषा *pirhiya* and the सगुन *sagūn*.

180. This completes the description of the main frame of the cart.

We now come to the various contrivances for retaining goods in the cart. These are the following, but they are not all used in the cart:—

181. At the rear of the cart, just in front of the चाक *āk*, is tied a thick bough of wood. This is called the पडुचा *pachhua*. It prevents goods falling out behind.

182. Over the पिदिषा *pirhiya*, and of equal length to the डेकानी *tekāni*, runs a bamboo called the तीज *tij*, supported by two stout pillars about a foot high, each standing on one end of the पिदिषा *pirhiya*. These pillars are called the खुन्त्री *khuntri* or खुन्त्रा *khuntra*, local variant

being खुंटहरौ *khuntahri* (Saran and South Tirhut) and खुंटेहरौ *khuntehri* or खुंटिहरौ *khuntihri* in Shahabad. In Gaya similar posts are called मॉंची *mānchi*.

183. Two very long bamboos now form *sides*, each resting on one end of the चाक *āk*, on a बिसेया *bitaiya*, and on one end of the तीज *tij*. Each projects behind the चाक *āk* and a long way in front of the तीज *tij*, and is called बल्ला *balla*. Other names are बाँस *bāns*, बाँसबल्ली *bānsballi*, बाँसौरा *bānsaura* (Shahabad), or चंदवा *chandwa* (Patna).

184. Sometimes bamboos run from end to end. These are called चीप *chip* when they commence at the टेकानी *tekāni* and run close under and fastened to the फर *phar*, up to the सगून *sagūn*. They serve to strengthen the फर *phar*. When they run the whole length of the cart, from the चाक *āk* to the सगून *sagūn*, and form as it were the string of the bow formed by the body of the cart, running close to and parallel with the झटका *jhalka* (*vide post*), they are called लप्पा *lappa* or (in Tirhut) लप्पु *lappu*. They are fastened to the body of the cart by ties, known as दौंगली *dāngli* in Sāran, दौंगड़ी *daungri* in East Tirhut, बाधी *bādhi* in Shahabad, जौंदा *jaunrha* in Gaya, and सौंठ *sonth* in South Bhagalpur. Elsewhere they are simply रसा *rassa*, &c.

185. Sometimes the बल्ला *ballā* is raised behind by a pillar (खुंटरी *khuntri*) at each end of the चाक *āk*, and the space between it and the body of the cart filled up with a rope *siding*. This rope *siding* is then called बाँसबाचा *hanthwāsa*, or in Patna फड़का *pharka*, and in Sāran एड़ा *era*.

186. The flat board forming the *driver's seat* is called मोहरा *mohra*, or in South Bhagalpur मोदा *morha* and in Shahabad मुँहरा *munhra*.

187. *The parts underneath the cart supporting the inner end of the axle-tree.*—There are two supports inside each wheel, like the तुलावा *tulāwā* outside. They cross each other opposite the inner end of the axle which passes through the intersection. As each wheel has a separate short axle, there are therefore two independent pairs of these, one inside each wheel.

188. The rear one of each of these pairs is called गुरिया *guriya* or गोरिया *goriya*, or (in Patna) खजाना *khajāna*. Like the rear तुलावा *tulāwā*, its upper end is fastened into the चाक *āk*. It is strengthened in its place in the चाक *āk* by a strut, called मेहराब *mehrab*, and the two गुरिया *guriya* are further strengthened by a cross-piece called चंदरौ

heri, joining the two, which thus prevents them approaching each other. The annexed illustration will make this clear.

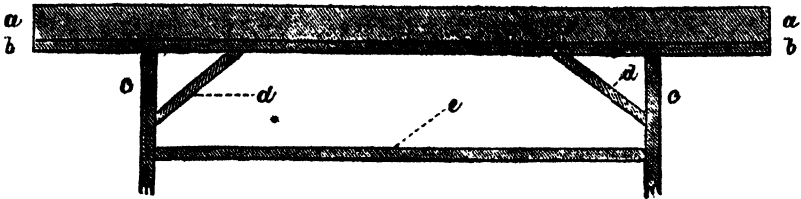

- a—a = the *āk*.
- b—b = the *parāk*.
- c, c = the two *goriya*.
- d, d = the two *mehrab*.
- e = the *danhari*.

189. The front supports of these pairs are each called *थोभ* *thobh* or *thop*. The upper ends of these are fixed in the *डेकानी* *tekāni*.

190. The apparatus for keeping the body of the cart curved.— consists of a set of strings called *झटका* *jhatka*, which passes right over the cart from end to end, one end being fastened to the *चाक* and the other to the *सगुन* *sagūn*. This is kept tight, so that it keeps the whole cart bent exactly like a bow.

The following illustration shows the arrangement :—

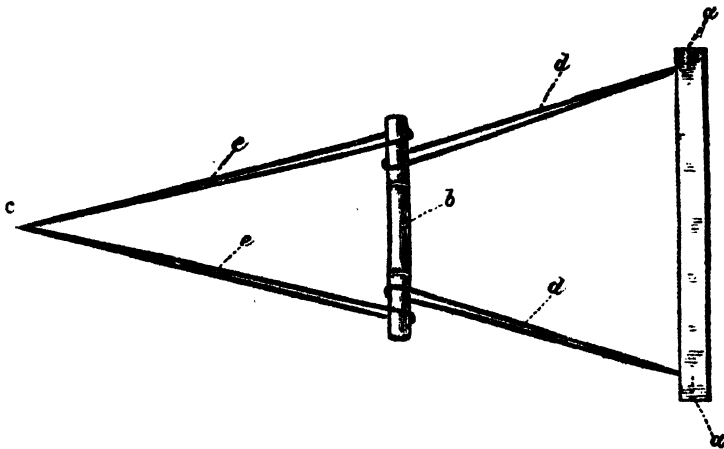

- a—a = the *āk*.
- b = the *danta*.
- c = the *sagūn*.
- d = strings fastened to the *āk*, passing round the *danta* and back to the *āk*.
- e = strings fastened to the *sagūn*, passing round the *danta* and back to the *sagūn*.

191. The *दन्ता danta*, or in south Bhagalpur *अमेरी ameri*, in the above figure is a stout piece of bamboo. It will be evident from the figure that it affords increased leverage, and offers a ready means for tightening the *जहका jhatka* when necessary. Sometimes bamboos run parallel to the *जहका jhatka* from the *सगून sagūn* to each end of the *आक āk* as further strengtheners. These are called *लप्पा lappa* or (in Tirhut) *लप्पू lappū*.

192. The *छतिया chhatiya* is a slip of wood fastened across and under the body of the cart from *थोभ thobh* to *थोभ thobh*, which serves to hang baskets, &c., from.

193. The point which is the front of the cart, and which forms the apex of the triangle, is, as already stated, the *सगून sagūn* or *सगुनी sagun*. It is here that the yoke is fastened. Underneath it, to prevent the point resting on the ground, is fixed a stout peg, called *उटनरा utra*. On the top of the *सगून sagūn*, to afford a boss for fastening the yoke to, is fixed the *मुँहथोपड़ा munhthopra*, *मुँहथपड़ा munhthapra*, or (south of the Ganges) *मोथापड़ा mothāpra*. In Champaran it is called *मोहनड़ा mohra*.

194. The *yoke* is *जूआ jūa*, and also in Shahabad *जूषड़ jūar*, as distinct from *पालो pālo* or *जूआठ jūāth*, a plough yoke (see § 14). The pegs passing through the ends of the yoke, outside the bullocks' necks, to prevent them shirking their work, are made either of wood or iron. The name *समैल samail* is generally applied to them when of wood, and *सेमल semal*, *सम्मल sammal*, or *सिम्मल simmal* when of iron; but this distinction is not always observed. To the east they are called *कनैल kanail*. The inner pegs towards the middle of the yoke, on the inside of each bullock's neck, are called (in East Tirhut) *चिरैया chiraiya*. They may be of either iron or wood.

195. *Props*.—When the bullocks are unyoked, the front of the cart is supported at the *सगून sagūn*, to prevent it falling forward, by the *सिपावा sipāwa* or (in North-East Tirhut) *सिरपावा sirpāya* and (in Saran) *सिपवा sipwa*. The top of this is called in Gaya *मँजा mānjha*. The prop to prevent the cart falling back is *एड़ा era*, *उलरवा ularua*, *सिधवार sidhucū*, or (in Patna) *लरवा larua*.

196. The *ropes* which go round the bullocks' necks are *जोना jota*, *जोनी joti*, or *गलजोनी galjoti*. When three bullocks are yoked, the rope which goes over the leader's neck is to the west *दिँरिया dinriya* or *बिरिया biriya*, and in Saran and the east *जिही jhitti*. The rope (*रसी rassi*, &c.) by which the yoke is kept in its place is called *बिहुवा bichhua*, or in North-East Tirhut *भौँक jhonk*.

197. The *mat* put in the bottom of the cart to prevent grain from falling out is चतर *chatai* generally, but it is हरियार *hariyār* in Patna and भंडारी *bhandāri* in South Bhagalpur. The last is also used optionally in Gaya and East Tirhut. In Sāran a canvas mat used in the same way is called धाला *dhāla*.

198. The *iron chain* for tying up the bullocks at night is generally सीकर *sīkar* or जनङ्गीर *janṅgīr*. Local names are पाही *pāhi* or दानर *dānrar* in Champāran and Tirhut, बेल *bel* in Gaya, and पैकल *paikal*, (also in Gaya) पैकर *paikar*, or पैकड़ *paikar* in Shahabad. The portion round the bullock's neck is called गरदनी *gardani*.

199. The above is the description, except where otherwise stated, of a very complete चक्रवा *chhakra*, which is itself the most complete kind of cart. Few carts are as complete as this; but they differ merely in being less complete, and in no other way.

200. As regards size, the cart of which the above is a description had the following measurements, a cubit being taken as equivalent to $1\frac{1}{2}$ feet:—

	Cubits.
Length from आक <i>āk</i> to टेकानी <i>tekāni</i> ..	1½
„ टेकानी <i>tekāni</i> to पिड़िया <i>pirhiya</i> ..	1½
„ पिड़िया <i>pirhiya</i> to सगून <i>sagūn</i> ..	3
<hr style="width: 10%; margin-left: auto; margin-right: 0;"/>	
Total length ..	6 cubits, = 9 feet.

The आक *āk*, टेकानी *tekāni*, and तीज *tij*, were each three cubits long.

The बाला *ballā* were each six cubits long, and the खुंटरी *khuntri* one foot. The wheel was two cubits across.

The greatest height of the arch was at the पिड़िया *pirhiya*, where it was one cubit.

The height of the सगून *sagūn* from the ground when supported by the सिपावा *sipāwa* was $2\frac{1}{2}$ cubits, and that of the आक *āk*, at the same time, $1\frac{1}{2}$ cubits.

CHAPTER III.—THE LIGHT COUNTRY CART.

201. This is सगड़ *saggar*, सागड़ *sāgar*, or लड़िया *larhiya* (see § 117). In Sāran it is called गाड़ा *gāra*.

This cart is rougher, lighter, and cheaper than the चक्रवा *chhakra*.

202. The *wheel* is the same as in the चक्रवा *chhakra*.

203. *The axle.*—There is only one axle (बूरा *dhura*), which goes right across under the cart, and on which both wheels run. It runs through a block of wood which runs across from wheel to wheel, and out of each end of which the ends of the axle project. This block is called मँदरा *mandra*. The projecting ends of the axle receive the wheels, which are held in their places by outside *linch-pins* (धुरकिल्ली *dhurkilli*, &c. (see § 164). Sometimes the wheels of the सगड़ *saggar* are protected by a board outside, one end being fastened to the चाक *āk* and the other to the टेकानी *tekāni* (see §§ 172, 173). Through this the end of the axle projects, and is made secure by the *linch-pin*. This board is called पँजनी *panjuni*, पँजनी *panjani* (Shahabad optionally), or (North-East Tirhut) पँगनी *pengni*, and must be distinguished from the different wheel support bearing the same name in the चक्रड़ा *chhakra*.

204. The body of the सगड़ *saggar* is not arched, as in the चक्रड़ा *chhakra*. It is simply a flat triangle of wood, principally bamboo. The two long sides of the body, commencing at each end of the चाक *āk* and ending together at the सगून *sagūn*, are called, as in the चक्रड़ा *chhakra*, फड़ *phar*, &c. As the सगड़ *saggar* has no तुलावा *tuliwa*, थोभ *thobh*, or गुरिया *guriya*, the body rests directly on the axle, being supported by two blocks of wood, called तेलला *tella*, तेलहिया *tetaliya*, or in Saran तंतुला *tentula*, each of which rests on one end of the मँदरा *mandra*, and on which, on the other hand, the corresponding फर *phar* rests. Along the फर *phar*, and underneath it, is tied a bamboo to strengthen it. This is called बाँगर *bāngar*.

205. In other respects a सगड़ *saggar* differs little from a चक्रड़ा *chhakra*, except that it is built lighter and almost entirely of bamboo. As the body is not arched, the former has of course no जठका *jhatka*, &c.

CHAPTER IV.—THE BULLOCK CARRIAGE.

206. When it has four wheels, it is called रथ *rath* or रन्थ *ranth*. This is rare in Bihār.

207. When it has two wheels, it is called बहल *bahal*, with variants बहेली *baheli* (Patna) and बहली *bahli* (Shahabad and Gaya).

208. This cart is almost exactly the same in principle as the चक्रड़ा *chhakra*, except that it is generally built lighter. On the square portion at the back is reared a kind of canopied seat, called साँगी *sāngi* or साँगी *saungi*; hence the cart is also called a साँगी गाड़ी *sāngi gāri*.

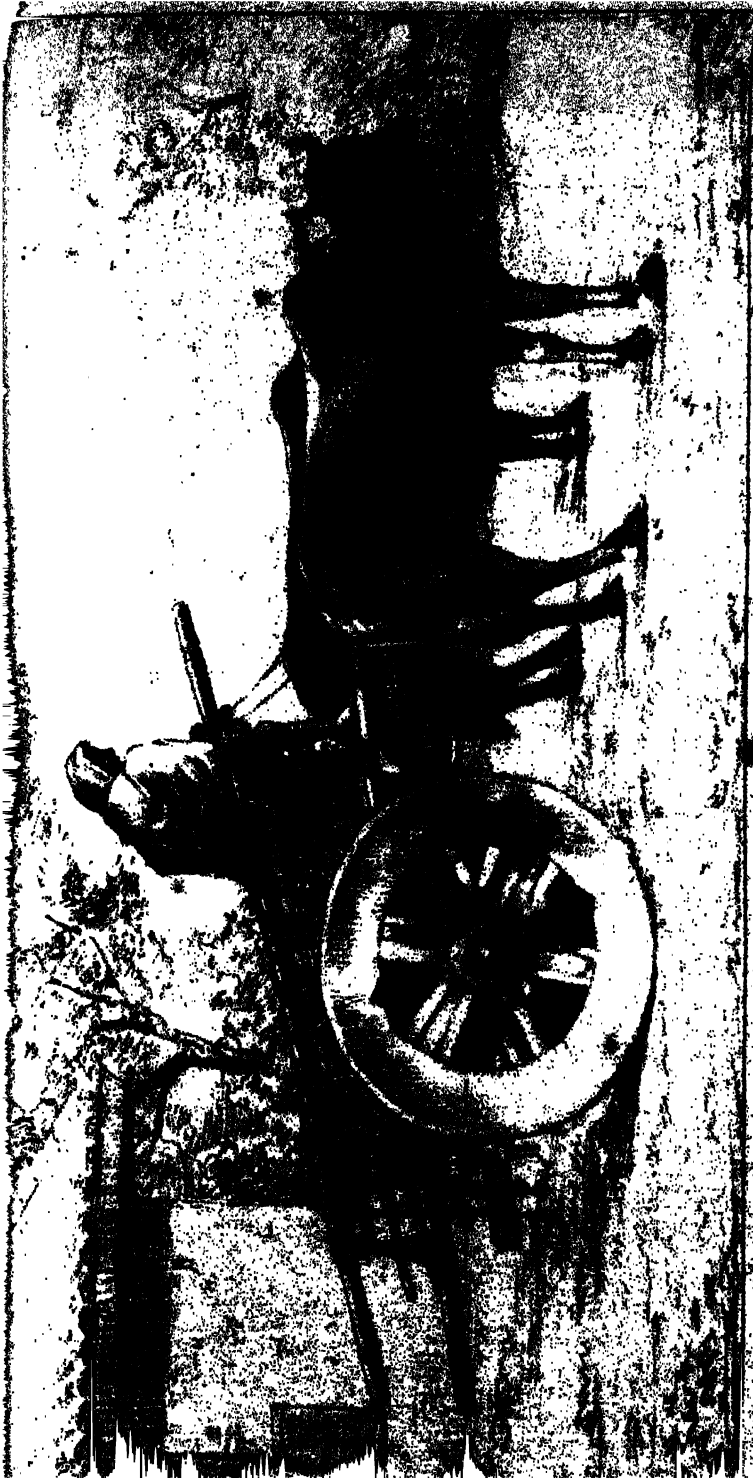

The Light Country Cart (Saggar)

Illustration by the artist, School of Art, Calcutta

Printed by the Government of India, Calcutta



209. Its parts are as follows :—

The wheel.—As in a cart (see § 151 and ff.).

The leather washer is called चकली or चकली *chakli*, गद्दा *gadda*, or बिठरै *bitharai*.

210. *The axle.*—As in a cart (see § 166).

211. *The supports of the wheels and axles.*—These are the same as in a चकड़ा *chhakra* (see § 167 and ff., § 187 and ff.).

212. *The body of the vehicle.*—The lower part is like a चकड़ा *chhakra*. Over it is placed the following, the whole of which is called साँवगी *sāwgi* or साँगी *sāungi*.

213. The frame of the seat is पट्टी *patti*, local variants being पहा *patta* (East Tirhut and Patna), पटिया *patiya* (East Tirhut and the west), and बौदन्दी *baudandi* (Gaya). Its supports are खून्टा *khunta* or खुन्टा *khunta*. On these are ornamental brass knobs, called फुलिया *phuliya*. The posts supporting the awning are दन्दा *danda* or दन्दा *danda* (East Tirhut and the west). The top of the awning is हतरी *hhatri* or (in Shahabad and Gaya) ठहरी *thatri*, and the stuffed cover to keep off the sun is गद्दा *gadda* or गदेला *gadela*. In South Munger it is गद्दी *gaddi*. The net forming the bottom of the seat is साँवगी *sāwgi* or साँगी *saungi*, and the leather guard of the body inside the wheels is धमाका *dhamāka*.

214. The two long sides are called फर *phar*, &c., or ताँगा *tānga*, as in the चकड़ा *chhakra*. Between them are placed narrow planks, called माँजा *mānjha*.

215. The supports of the body behind are धरुवा *dharua* or हँरुवा *dhanrua*, and similar smaller ones inside are बावली *bāwli*.

216. The दंतुवा *dantua*, or in Sāran धाला *dhala*, is the back seat for carrying luggage, and it is also called अरानी *arāni* in South-East Tirhut and Champaran. डोरी *dori* are the strings forming the side of the awning, and पर्दा *parda* is the side awning, which may be raised or let down as required. In Sāran it is also called ओहार *ohār*.

217. The rails on each side of the driver's seat are बल्लो *balli*.

218. In other respects the bullock carriage is the same as the चकड़ा *chhakra* (see Chapter II).

CHAPTER V.—THE PONY CARRIAGE.

219. This is nearly the same as the bullock cart, on a smaller scale, except in the following particulars :—

220. The *wheel* is the same as in the bullock carriage (see § 151 and ff.).

221. The *axle* is धूरा *dhūra* or धूरी *dhūri*, which is strengthened inside by a short metal tube, सामा *sāmma*, सामा *sāma*, or सामी *sāmi*. In North-East Tirhut the latter is also called साम *sām*. There is one of these inside each wheel, and they act as a kind of washer. There is only one axle (धूरी *dhūri*), on which both wheels run. Outside each wheel are a pair of तुलावा *tulāwa*, but inside there are no थोभ *thobh* or गुरिया *guriya*, as in the bullock cart (see § 187 and ff.). Round the ends of the टेकानी *tekāni*, the चाक *āk*, and the axle, forming a triangle outside the wheel, is tightly tied a rope called the जन्त *jant*, and just above the lowest angle of this triangle (*i. e.*, just above the point of axle), is tied to it a short stick serving as a footstep, called सलार *salāi* or सलैया *salaiya*.

222. The तुलावा *tulāwa* are fastened to the चाक *āk* and the टेकानी *tekāni* (see §§ 167, 172, and 173) by iron hooks, called अँकुरी *ankuri* or (Champāran, South Tirhut, and South Munger) अँकुरा *ankura*. South of the Ganges they are also called in Shahabad and South Bhagalpur तुलार *tulāi*. हाल *hāl* is the tire of the wheel. The leather splashboard over the wheel is तखन्ना *takhta* or तखन्ती *takhti*. In South-West Shahabad it is called पटगरा *patra*.

223. The props of the *body* are दन्दा *danda* (west), दन्दा *danta* (east and Champāran), or खूँटा *khūnta*. The top of the awning is चहत्री *chhatrī*, and the roof of it is चह *chhat* or (in Gaya) तड़क *tarak*; गदेला *godela* or (in South-East Tirhut and South Munger) गद्दी *gaddi* is a cushion at the top to keep off the sun. The awning at the sides is परन्दा *parda*, or in Sāran घटा टोप *ghata top*, which is fastened by iron rings, कड़ी *kari* or (in Gaya) खोली *kholī*. The ropes which support the awning poles are हथवॉसा *hathwānsa*, and the rope trellis between the two rear awning poles चौक *chauk*. This last serves as a back to lean against.

224. The खूँटा *khūnta* or खूँटरा *khuntra* are posts which support the body in front on the axle. धरवा *dharua*, धारवा *dhārua*, or (in South Bhagalpur) धालुआँ *dhāluān*, are the posts which support the body on the axle behind the खूँटा *khūnta*. बावली *bāwli* or बौली



PONY CARRIAGE (EKKA), WITHOUT CANOPY.

Han Choudhury, Student, Govt. School of Art, Calcutta.

Printed by Abdee! Rohim Govt. School of Art Calcutta.



AN EKKA WITH CANOPY.

bauli are similar posts behind the *खंडा khanta*, but in front of the *धरुवा dharua*. They are quite inside the body of the cart. To the west of the North Gangetic tract they are also called *गज ganj*. The *पोंछिया ponchhiya* or (to the west) *पिछुवा pichhua* are the pointed ends of the lower shafts behind. In South Bhagalpur they are called *दगन्धी dagli*. *तान tãn* are the four iron bars which support the body on the axle. Two of them are called *खुंटान khuntãn* or (in South-West Shahabad) *गजवान गजबãg*. *मंजा mãnja* are similar wooden supports. The *सॉन्गी sãmugi* or *सौंगी saungi* is the twine net under the seat, and the straps which keep it up are the *सौंगी के नारी saungi ke nãri*. The *गोड़िया goriya* are side ropes which fasten the splash-board to the axle, and the *धमाका dhamãka* is the leather siding inside the wheels. The four curved bamboo shafts are *तंगा tãnga* or (in Patna) *टांगा tãnga*. The *छाती के नारी chhãti ke nãri* is a strap inside, fastening the body to the axle in front of the *सौंगी के नारी saungi ke nãri*. The *लदाव ladãw* are cross-pieces of bamboo from shaft to shaft, forming the body of the cart. In North-East Tirhut they are called *फठी phathi*, and in South Bhagalpur *बत्ता battã*. The net at the bottom is *जाला jãla*, and the *अडन्धी jhatka* is a strong rope behind and below, fastening the cross-pieces of the body.

225. The driver's seat is *करन्तली kartali*. The pieces of bamboo which run underneath from shaft to shaft, on which the driver rests his feet, are *लतखोरा lathkora* generally north of the Ganges, or *दरेंरी darenri* in Saran and *डंड़ेरा danrera* in South-East Tirhut. In Shahabad they are *लतेड़ा latera*, in Patna and Gaya *दड़िया danriya*, and *तरेरा turera* in South Bhagalpur. The *गोड़िया goriya* or (in South-East Tirhut) *घोड़िया ghoriya* are pieces of wood which join the upper and lower shafts. *पन्ही pankhi* are pieces of leather joining the upper and lower shafts near the yoke. These shafts are also fastened by a leather rope called, north of the Ganges, *मुथरा muthra*, and to the south of it *मोथड़ा के नारी mothra ke nãri*, or in Shahabad *मुंथड़ा के नारी munhra ke nãri*. In Patna and Gaya it is called *चहरा chhara*. The *मोथपड़ा mothapra* is a brass cap fitting on to the ends of the two shafts.

226. *Harness*.—The pointed part of the saddle is *खोगीर khogir*, or in Shahabad and East Bhagalpur *खगूर khagūr*. The pad is *गद्दी gadi* or *नद्दी gaddi*. The wooden block is *कठरा kathra* or (in South-West Shahabad) *कठला kathla*. The rings through which the reins pass are *करा kara* or *रास करी rãs kari*. The leather surcingle going over the saddle, round the horse's shoulders and across his chest, is *पुसतंग pushtang* or *पुसतङ्ग*

pustang. Another name is जोन *jot*. The leather belly-band is तङ्ग *tang*. रास *rās* means the reins; तावा *tāwa* or (in South Bhagalpur) तवक *tawak*, the leather cover of the saddle; नागन्ना *nāgla*, नगन्ना *nagla*, or तसन्ना *tasma*, the straps which fasten the shafts to the saddle; and कैची *kainchi*, the wooden side supports of the saddle. Other names for this last are कैचिया *kainchiya* (Champan and Tirhut), गोड़िया *goriya* (South Tirhut, Patna, and Gaya), टिकन्डी के लकड़ी *tikthi ke lakri* in South-West Shahabad, and टेकन्डी *tetkhi* in South Bhagalpur. दुमन्ची *dumchi* or दुमन्कजा *dumkaja** is the crupper. The bridle is पूंजीपट्टा *pūnji patta*, and the iron bit लैगाम *lagām*. The martingale is जेरबन्द *jerband*, the cloth over the eyes which serves as blinkers अंधारी *andhāri*, the neck-ornament कन्था *kantha*, and the brass moon on the horse's forehead चाँद *chānd*.

227. गँजिया *ganjiga* or तोबन्ना *tobra* is the bag hung on either side for holding the passenger's shoes, &c.

228. The above is a description of an एक्का *ekka* when the canopy is attached. When this is taken down, a back railing is added, कटहरा *katahra*, instead of the rear posts, and instead of the two front posts two shorter ones are set up, one on each side of the driver's seat, called निमन्दा *nimdanda*.

CHAPTER VI.—THE COUNTRY BOAT.

229. Boats are of various kinds. The following may be noted :—
The general term for a boat is नाव *nāw*, and to the west also नैया *naiya*.

230. The larger *kinds* of boats are उलँक *ulānk* (which has a long narrow bow overhanging the water in front), मेल्हनी *melhni* (which has a broad bluff bow), पटेली *pateli* or पटैली *pataili*, also called in Saran कतरा *katra* (on which the boards forming the sides overlap and are not joined edge to edge), कच्छा *kachchha* (which is shaped like a square shallow box, without proper bow or stern, and is steered with two rudders. It takes great hurdens, and will go in very shallow water), and the सरङ्गा *saranga*, or in Shahabad सलीमा *salīma*, and in Tirhut सरिन्ना *sarinna* (which has a round bottom for shallow water).

231. Smaller varieties are डोहट *dohat* or in Shahabad डोपट *doēt* (which has a flattish bottom for shallow water, and has its bow and

* The fate of the *ekka* pony is well shown in the proverb दाना नर घास दुन चाँक दुमन्कजा *dāna na ghās, dunu sājh dumkaja*,—no grain or grass, and the crupper on night and morning.

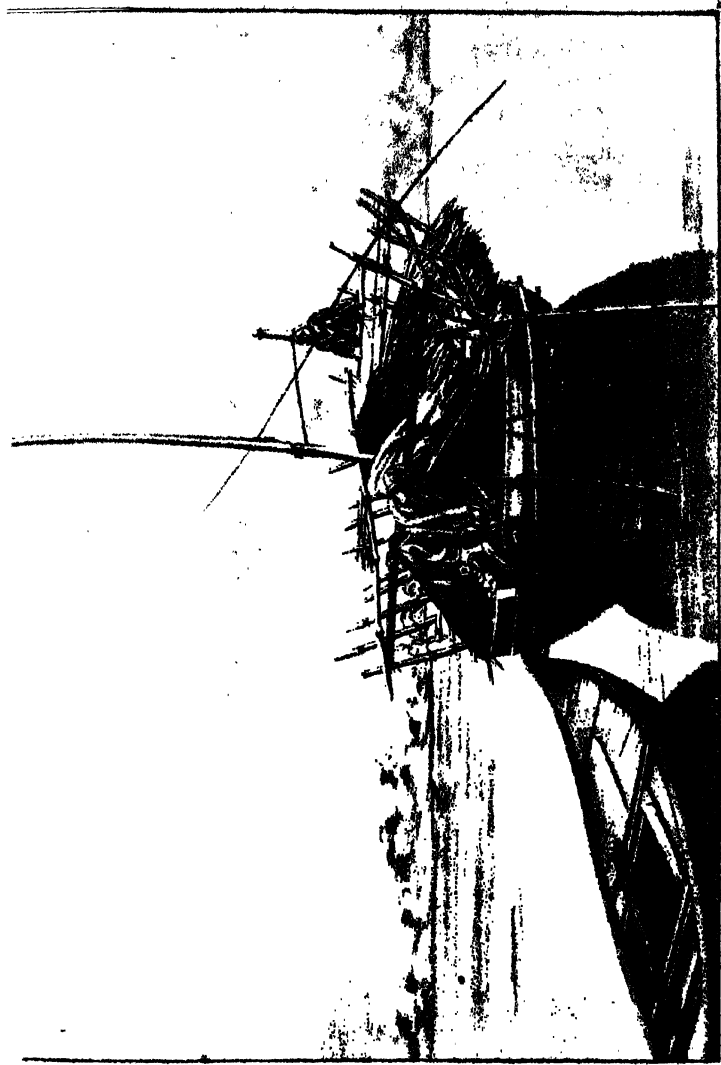

PALWĀR.

Lith. by H. C. Ghosal, Student Govt. School of Art, Calcutta.

SARANGA.

Printed by A. Rohim, Govt. School of Art, Calcutta.

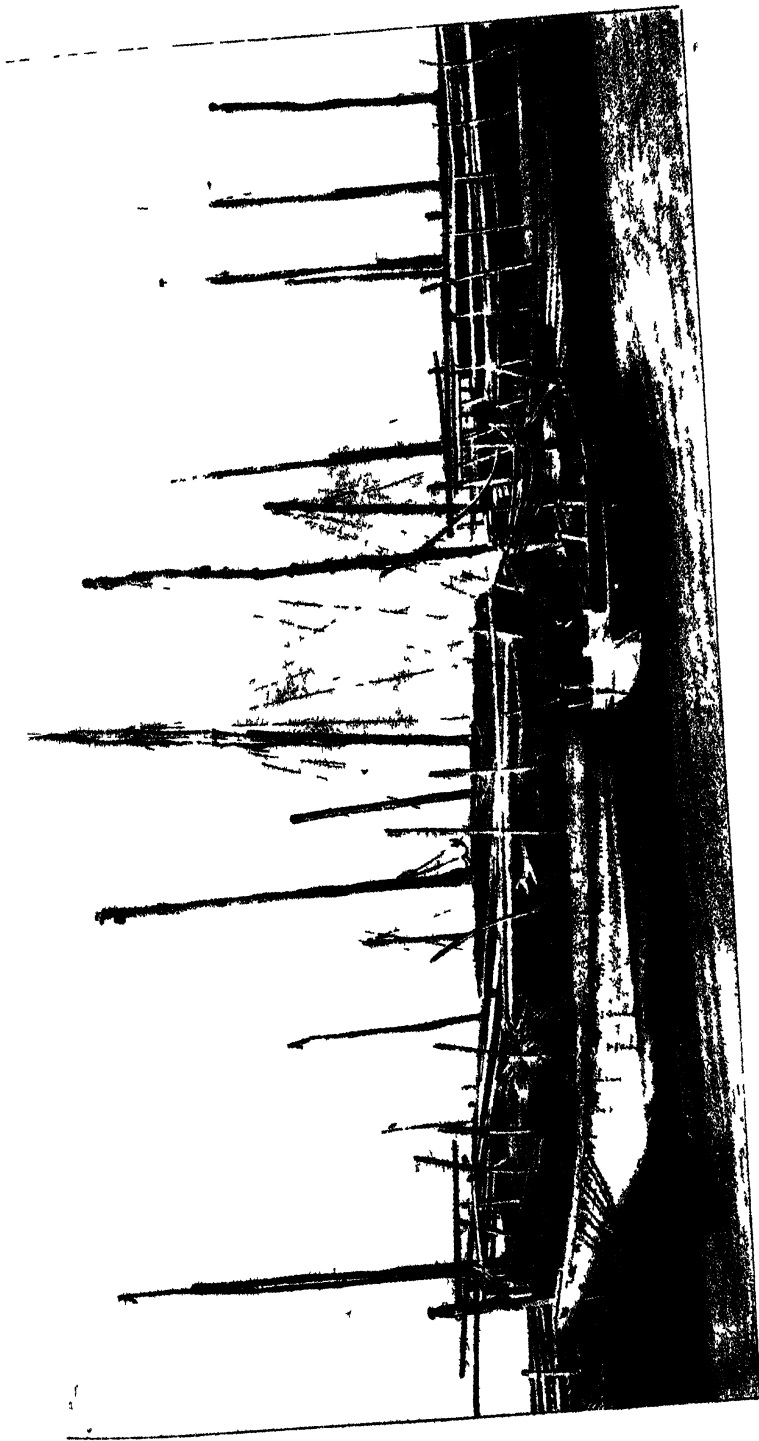

A GROUP OF MELHINIS.

Printed by Abdool Rohim, Govt. School of Art Calcutta.

J. Schaubbar & Lith.

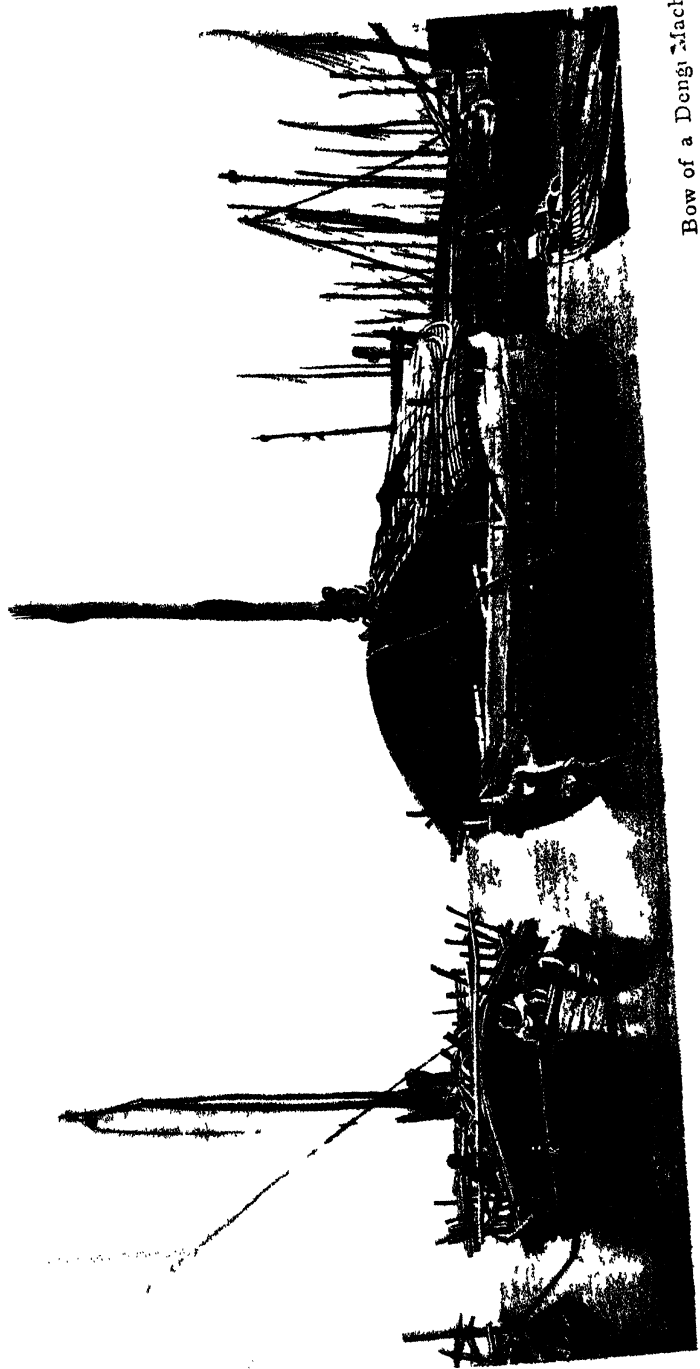

Bow of a Dengi Machhua.

Pansûhi

BOATS USED IN BIHAR.

Dohat.

Stern of a
Melhni.



PATAILIS
UTĀNK

SARINGA.
PATAILI.

Printed by Alidival, Kucham Govt. School of Art, Calcutta.

ern portions out out of solid wood), and पनसुही *pansūhi* (which has round bottom, but goes in shallow water).

232. The smallest kinds are पखवार *pakhvār* or skiff and एकडा *ekṭha* dug-out. The latter is also called बंग्ला *bangra*. Also the ओलनेया *olnaiya*, with both ends rising like a gondola well out of the water, and which cannot sink. Another similar boat is called the उँगी महुषा *uṅgi machhua*, or dingy. घरनरै *gharnarai* (South Bihar) is a temporary ft made of water-jars (घड़ा *ghara*) and bamboos tied together.

233. The parts of a boat are as follows:—The thwarts are गूदा *gūrha* and the ribs बाता *bāta* or (in Champāran) उरुबाता *urubāta*, उरिया *urhiya* (in Champāran and North-West Tirhut), गोहा *gochha* (in Saran and North-West Tirhut), गुहा *guchchha* (in North-East Tirhut), and काह *kāh* (in South-East Tirhut). Smaller transverse ribs are बाँक *bānk*. The outer planking is हार *hār* or (in South Munger) बाकल *bākal*, (in Champāran and West Tirhut) बगल *bagal*, and (in North-East Tirhut) काह पाटी *kāchhak pāti*. In Gaya it is जलमहार *jalamhār*. In Shahabad the planks which run from end to end in the length of the boat are अहार *ahār*, and देवाल *dewal* is also used to mean the “wall” or side planks. The flooring inside the boat is पाटन *pātan* or पटवटन *patwatan*, (in Saran पटौरी *patauri*). A long plank running over this is in Shahabad अपत्ती *apti*. The grating above the bottom of the boat is चाली *chāli* or (in South-West Tirhut) उरुहा *urhrha*, and (in North-East Tirhut) पटार *patāi*. In a पटौली *pataili* the planks at the bottom which run from end to end are लेवा *lewa*, and in other kinds of boats मरिया *mariya* or (in North-East Tirhut) मरेया *mareya*, and in Saran मोरिया *moriya*. The platform on which the rower sits is पटौरी *patauri* or बिटन *bitan*. When on the roof of a large boat, it is बीट *bit* or पटार *patāi*, or in Shahabad हलमखानी *halmachāni* or मखान *machān*. The deck planks in the middle are पाटना *pātna*. चचार *chachār* is brushwood put in the bottom to stand on. कड़वा *karwa* or कड़वा *karwa* are the posts which support the thwarts. जौंका *jonka* are iron rings to which the roof of the boat is fastened by ropes. In North-East Tirhut and South Munger they are called करी *kari*.

234. When a boat is calked with the bark of the परास *parās* tree (*butea frondosa*) the calking is called रसवत *raswat*, and when with hemp it is गहनी *gahni*. अटार *atār* (in Champāran and North-West Tirhut) is string used for calking.

235. The keel, which is the first plank laid in making a boat, is सिका *sikka*. In Champāran it is सहन *sahan*, and पतौन *patain* or दंडा *danda* in South-East Tirhut. It runs the whole length of the boat, and hence

दिशा *sikka* is also used to mean the two ends of the boat. The length of the boat is दवर *dawar*, and the stern post गलही *galhi*. The prow is मलङ्ग *malang*, माँगी *māngi*,* or माँग *māng*.

236. The rudder is पतवार *patwār* or (in North Tirhut) पतिवार *patiyār*. In Gaya it is पडवार *patwār*. This is properly the lower piece. The rudder post is गोल *gol*, (in Shahabad, North-East Tirhut and, optionally, South Munger) खम्हा *khamha*, or in Gaya गौला *gaula*, and it is fastened to the thwart by a rope called नथिया *nathiya*. The tiller is सैला *saila* or (in South Munger and North-East Tirhut) डन्टा *danta*, and the socket in which it works बनरा *banra* or (in North-West Tirhut) डेल *thel*, and (in North-East Tirhut) डेहरी *thehri*. One rope, by which the rudder is fastened to the boat, is गङ्कसा *ganrkassa*, and another, by which it is held up, is अँकवरिया *ankwariya*. The steersman is माँगी *māngi*.

237. सेवता *seuta* or (in South-East Tirhut) सोता *sota* is the wooden vessel used for baling out water. An oar is डाँड़ *dānr*, a paddle कवचार *karuār*, केवचार *keruār*, or in Sāran कवचारी *karuāri*, and the blade of it पाता *pāta*. A punting pole is लगी *laggi* or लग्या *lagga*.

238. The mast is गुरखा *gurkha* or मस्तूल *mastūl*, or in Shahabad गुनरखा *gunarkha*, and the yard is मोरनी *morni*. The mast is raised on a post to which it is spliced. This is दरखुधा *darsūdha* or जसोधा *jasodha* in South Munger and Tirhut, जारखुधा *jarsudha* in Champāran, and जावसधा *jawsadha* there and in North-West Tirhut. The socket in the bottom, in which the post is stepped, is दरखुधा के मलिया *darsūdha ke maliya* or मलवा *malwa*. The सतवनिचाँ *satwaniyān* is the thwart to which the post is tied. It is called in South-East Tirhut सूत *sūt*. The pulleys are घिरनी *ghirni*, and the sail is पाल *pāl*, and in Shahabad सूते *sūte* or सुतेवनिचाँ *surtwaniyān*.

239. The tow-rope is गून *gūn* or (in Gaya and the south-west) गोन *gon*, which is tied to pieces of bamboo called बेरुआ *berua* or खूँटा *khūnta*, or in Shahabad बरुआ *barua*, which the boatmen press against their shoulders when hauling a boat up stream. The man who tows is गुनवाह *gunwāh*. लहासी *lahāsi* is a cable, and लङ्गर *langar* or गिराबी *girābi* the anchor. A large iron anchor is लोहलङ्गर *lohlangar* or गिरामी *girāmi*.

240. To draw water (of a boat) is पानि तोड़न *pāni torab* to the east and पानि तूरल *pāni tūral* to the west, e.g. ई कख्खा बड़त कम पानि तूरत

* The most comfortable seat is in the bow. Hence the proverb जनिका खेवा पदि ई पगिका माँगी सवार *janikā khewa nahin, se agila māngi sawār*,—the fellow who hasn't money to pay his fare takes the bow seat.



ना i *kachchha bahut kam pani turat ba*,—this *kachchha* draws very little water. To be aground is डोकव *tikab*.

CHAPTER VII.—THE LITTER.

241. The litter is खटोली *khatoli*, डोली *doli*, or (in North-East Tirhut) खोटली *khotli*. डोली *doli* is also used for the ornamented litter used at marriages, which is also called in South Bhagalpur चनचोल *chandol* or तड़तड़वाँ *tartarwān*. The last word is said by natives to be a corruption of the Persian تاخت راول *takht rawān*, or moving throne. In the west it is also called नालकी *nālki* or बिहउती पालकी *biyahuti pālki*.

242. The bamboo pole is बाँस *bāns*, and from it the litter is suspended.

243. The litter itself is खटोली *khatoli*, and is a kind of small bed (चरपाच *charpāy*) with a bottom made of rough twine (सुतरी *sutri*). The sides and ends of the bed are पाटी *pāti*. In South Bhagalpur the sides are called पट्टी *patti* and the ends सिरवा *sirwa*. At each end two pieces of split bamboo run up from each corner, meeting about 3 feet above the bed, and thus forming a triangle. These bamboos are called सिपावा *sipāwa*, or in South Munger सिपावा *sipāha*, and in Sāran सिपवा *sipwa*, and they are fastened to the corners of the bed, and, at the apex of the triangle, to the pole by a string called बरकास *barkas*. This string is also twisted round the सिपावा *sipāwa* to strengthen them. A bamboo stick passes through the pole just behind the rear सिपावा *sipāwa*, and, descending perpendicularly, is braced to them by strings. This is called टेँरुवा *tenrua* or डेरुवा *terua*. It prevents the pole slipping round. The illustration shows a litter as carried by four persons, but this kind is more usually borne by two.

244. The feet of the bed are called पावा *paua*, and the strings for tightening the bottom of the bed are ओरचन *orchan*, and also in Shahabad ओरदावन *ordāwan*.

245. Fastened to the pole over the bed, and in a plane parallel to it, is an oblong framework of bamboo slips for supporting the canopy. This is called ठट्टरी *thatri*, and in South Bhagalpur also चतनी *chhatni* or चतनी *chhatri*; and the string braces descending from its four corners to the four corners of the bed, to keep this awning steady, are called तान *tān*.

246. The illustration shows a litter without the curtains. When a woman travels in it, the whole is enclosed in a set of curtains like a bell-mouthed bag, called ओहार *ohār* or परदा *pardā*.

247. A superior kind of litter, used by richer women, is मेढा *meḍā*, मेढाना *meḍāna*, महप्पा *mahappha*, दान्नी *dānri*, or दान्नीया *danriyā*. It has a domed roof, called ठात्री *thatri*, supported on eight pillars (four at each side), called दन्टा *danta*. The side-boards of the body are called दीवाल *divāl*, or in Shahabad दिहवा *dilhā*, and the doorway दुहारी *duhāri*, or in South Munger दुहारी *duhāri*. The rest is like the डोली *ḍolī* etc.

248. The बरहदारी *bardari*, or in Shahabad बरहदारी *barahdari*, as called in Saran बरहदरिया *kharkhariya*, is the corresponding litter used by wealthy men. It is the native form of the Europeanized palanke. In this the side-pieces at the bottom are called पाटी *pāṭī* or पटिया *pāṭiya*, the net bottom बिनावट *bināwat*, the legs पोचा *pauca*, the side-board पट्टरी *pāṭṭrī*, the four pillars at each side सिपोचा *sipauca*, the doorway दुहारी *duhāri*, and the roof चह *chhat*. The shelf inside at the feet of the litter is दराज *darāj*.

249. The poles are called बाँस *bāns*, and the curved end of the front pole थोप *thop*. The four iron struts at each end are called ताम *ṭām* and they meet in a ring (चुकिया *chukiya* or in South Bhagalpur सामी *sami*), which goes round the pole. The inner end of the pole rests in a socket in the end of the litter, which is also called चुकिया *chukiya*, also in South Munger सामी *sāmi* or खुबिया *khubiya*. The rope network filling up the space between the two lower struts at each end is called कासावट *kasāwat*, or in South Bhagalpur कसन *kasan*.

SUBDIVISION VII.

APPLIANCES USED IN RURAL MANUFACTURE.

CHAPTER I.—APPLIANCES USED IN THE MANUFACTURE OF OIL.

250. The oil-mill is known as कोल्ह *kolh* or कोल्हु *kolhu* throughout the province. In Gaya it is also केल्हु *kelhu*. It closely resembles a sugar-mill, as described in the next section, and a detailed description is not necessary. Nevertheless, owing to the circumstances of the case therein, it has been found inconvenient to give an illustration of a Patna oil-mill, and accordingly the following description of a Patna oil-mill is here given in order to explain the accompanying sketches. In these reference can be made in reading the section on the sugar-mill in which the few points of difference are noted. A well-known pro-

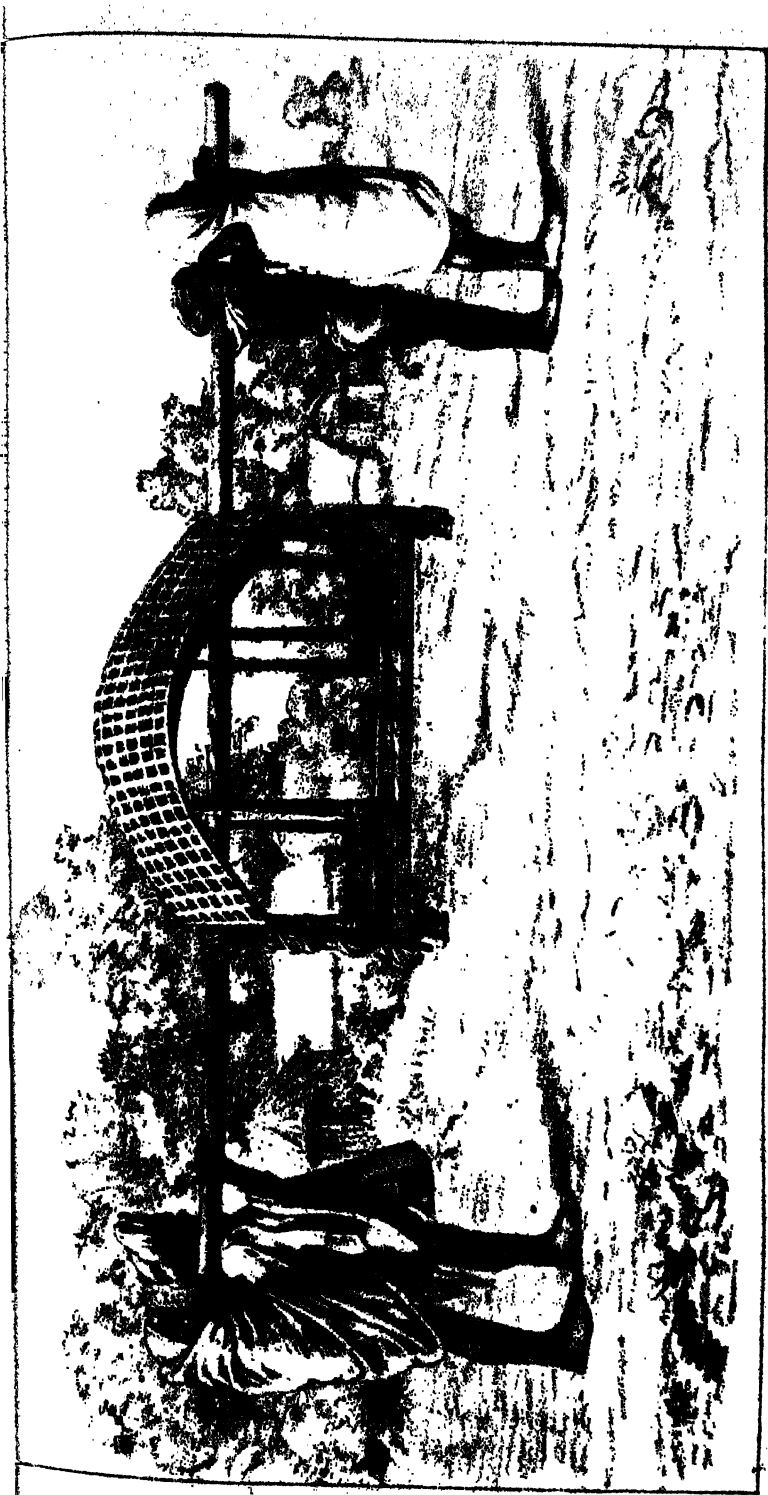

1

LA BIBLIOTECA DEL MUSEO DI STORIA NATURALE E ZOOLOGIA
DELLA UNIVERSITÀ DI TORINO

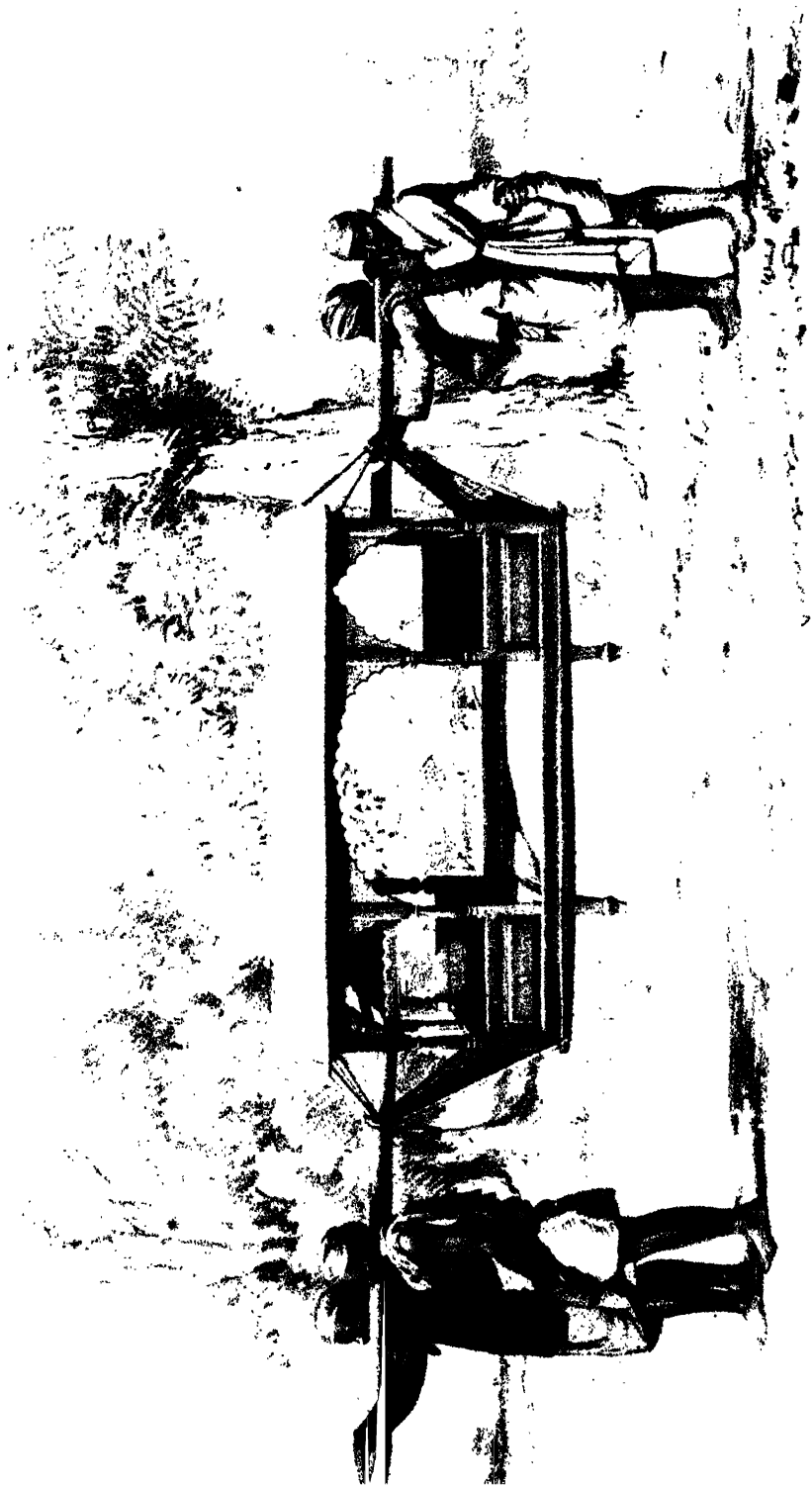



the in *Amos* 11/12/13

about the oil-mill is देव खरी चाय नहिँ, कोख चाटे जाव *del khari khay nahiñ, kolh chātai jāy*,—(the bullock) won't eat oil-cake when it is given to him, and yet it goes to lick the oil-press; i.e., stolen goods are sweet.

251. *The hollow wooden block forming the bed of the mill.*—This is कोख *kolh* or कोखू *kolhu*, and in Gaya also केखू *kelhu*. In this the cavity in which the oil-seeds to be crushed are placed is known as पेट *pet* or हन्दा *handa*, or in North-East Tirhut कुँह *kūnh* and in Shahabad खान *khān*. In the oil-mill this cavity is shaped like an inverted cone, the apex reaching to about midway down the block. There it is about two inches wide, and thence it widens again like an hour-glass till it leads into the back of the top of the निरोख *niroh*. The lower half of this hour-glass cavity is known as अचरी *athri*. The lower end (मुँड़ी *mūñḍī*) of the pestle (महन *mahan*) is just wide enough to fit tightly into the narrow part of the cavity at the waist. The upper half of the cavity is that in which the oil-seeds are placed. It has a lining of a series of longitudinal pieces of hard wood, wider at the top and tapering to the bottom, which are very tightly wedged together. These are called पाचर *pāchar*. Sometimes, when these get worn away by the constant working of the pestle, a fresh lining is put inside them. In this case the old lining is called ठरपचरा *tharpachra*, or in North-East Tirhut तरपचरा *tarpachra*, and the new inner lining पेटपचरा *pētpachra*.

252. The block is buried very deeply in the ground to steady it. The part below ground is called जङ्घा *jangha*. Round the base a circular mound of earth is fitted, called भीँता *bhaunta*, or in South Bhagalpur भीँठो *bhauntho*, in North-East Tirhut भत्ता *bhatta*, and in Sāran मँहौटा *manjhauta*; and in this, below the exit for oil, a space is dug out for the vessel (चह्ना *chhanna*) receiving the oil.

253. The exit for oil is the triangular hole at the bottom of the block over the above-mentioned cavity. It communicates at its upper end with the अचरी *athri*. This oil exit, together with the cavity for holding the vessel, are together called निरोख *niroh*, and in Sāran and Tirhut also नरोख *naroh*.

254. The flat top of the block is called पारा *pāra*.

255. *The horizontal board to which the bullocks are attached.*—This is called कतरी *katri*. On it the oilman (तेली *teḷī*) sits, and while he drives the bullocks he at the same time keeps pressing down the seeds into the cavity with his left hand.

256. *The upright beam, or pestle, which moves in the hollow of the mill and crushes the seeds.*—This is मोहन *mohan* or मणन *m*. To the west it is also called जाठ *jāth*, or in Shahabad मोहन *monhan* in North-East Tirhut मोहैन *mohain*. The ball at the end of this beam which fits into the narrowest part of the hollow of the block, is मूँरी *mūri*. The ferrule round this is मुकुन्दारी *murwāri*. The notch at the end of this is कान्ह *kānh* or कन्हा *kandha*. The upper end of the pestle round off is चूर *chūr* or पूँची *pūnchhi*, and the curved piece of wood joining this is डेंका *dhenka*, or in North-East Tirhut डेंकुवा *dhenkua*. The curved block of wood connects the pestle with the upright post : this is fixed in the horizontal driving-beam : thus—

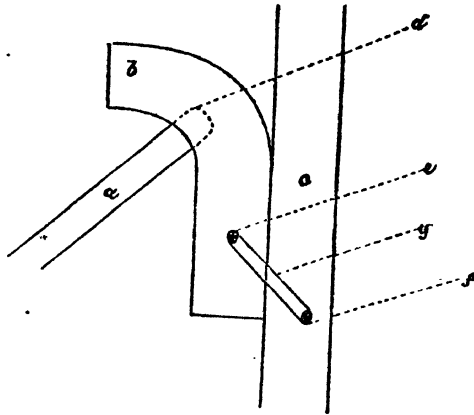

257. In the above sketch *b* is the डेंका *dhenka*, *a* is the top of मोहन *mohan* fitting into it up to the point marked *d*. The upright post is *c*, which is fastened to *b* by a string *g* passing round the pegs *e* and *f*.

258. The upright post is called मरथम *marthamh*, or in East Tirhut मलिक थम *malik tham*, the pegs *e* and *f* खुँटी *khūnti*, and the string नाधन *nādhan*, or in East Tirhut लाध *lādḥ* and South Bhagalpur लध *ledha*. The string is generally made of straw. The upright post is fastened to the horizontal board, कतरौ *katrī*, by a wedge, गकरी *garkilli*, which goes through the former and under the latter.

259. The horizontal board revolves round the main block of the machine; at the end of the board nearest the block is fastened a lump of wood called फेंडा *phenta*, or in Saran फेडा *pheta*, which acts as a kind of washer between the end of the board and the block, and it also rests against the latter, revolving in a horizontal groove (कान्दर *māndar*) cut in the latter's exterior surface. A bamboo

runs up from the inner portion of the horizontal board to meet the upright post, so as to strengthen the joint. It is called **खरचाडी** *khar-chāḍī*, or in North-East Tirhut **खंरचारी** *khanrchāri*, and in Gaya and Shahabad **खंरचर** *khanrchar*.

260. *The arrangement for stirring up the oil-seeds.*—This is called **रेवडी** *rewṭī*, or in South Bhagalpur **भरनाडी** *bharnāḍī* or **उठकनी** *utkani*, and does not exist in the sugar-mill. It consists of a peg, **खूँडी** *khūṅṅī*, standing up in the cavity amidst the oil-seeds, alongside the pestle; to its top is fixed a horizontal pole or handle, the other end of which is fastened to the upright post, **मरगम** *marthamh*, by another peg, **खूँडी** *khūṅṅī*. The whole therefore revolves with the pestle, the first peg moving amongst the seeds concentrically with it and stirring them up. At the same time the stirring is rendered more effective by the peg being perpendicular and the pestle on a slant.

261. *The yoking apparatus.*—The rope which is fastened to a peg in the end of the horizontal beam, passed round the hump of the bullock and back again to the beam, where it is tied into a hole, is called **काहा** *kārha*, and the rope passing under the bullock's chest, joining the two traces thus made, is **पेटी** *petī*. The canvas pad on the bullock's hump is **काँधी** *kāṅṅhī*, and the cloth or wicker basket by which he is blindfolded is **टोकनी** *tokni* or **खोला** *khola*, or to the east **खोला** *kholsa*. The rope from the bullock's neck up to the curved block or **डँका** *dhenka* is **पगवा** *pagha*, and the iron link fastened to this close to the bullock's neck is **भौर कली** *bhaur kali*. The rope round his neck, connected to the **पगवा** *pagha* by this link, is **गरदवानी** *garduwāni*, or in North-East Tirhut **गरदानी** *gardāni* and in Champāran **गरदानी** *gardāni*, and that going through the bullock's nose is **नाथ** *nath*. A bullock employed in an oil or sugar-cane press is called a **नाटा बैल** *nāṭā bail*.

262. *Miscellaneous.*—The circle in which the bullocks move is called **पौर** *puur* or **पौरी** *pauri*, and in South Bhagalpur also **भर** *bhar*.

263. The pot into which the oil drops is called **चहा** *chhanna*. As much oil-seed as can go into the press at one time is called **घानी** *ghāni*. The oil-cake which remains after the oil has been expressed is called **खली** *khallī*, or in Sāran **खरी** *khārri*, except the oil-cake of poppy seeds (**पोखना** *posta*), which is called **पीना खली** *pīna khallī*, or simply **पीना** *pīna*.

264. To work the mill is **पेरव** or **पेरव** *perab*.

CHAPTER II.—APPLIANCES USED IN THE MANUFACTURE OF SUGAR.

A.—THE CANE-MILL.

265. The cane-mill is known as कोह *kolh* or कोहू *ke* throughout the province. Patent mills introduced by European firms are known as कल *kal*.

266. It is apprehended that the following description of a country sugar-mill will be of little else than antiquarian interest, for such are fast disappearing from Bihār, being superseded by the English-made iron crushing-mill made at Bihia. To such an extent has the use of country mills died out, that the writer found it impossible to find a single one in the sadar subdivision of the Patna district which was a fit state for a photograph to be taken of it. They had all been broken up for firewood, only a few dismantled ones being available. For a general idea as to its appearance, the reader is referred to the illustrations of an oil-mill in the last chapter.

267. The following are the principal points of difference :—

- (1) The hollow in the block has perpendicular and not sloping sides, and it is hence cylindrical, and not conical, in shape.
- (2) The sugar-mill has no रोटरी *rotli*.
- (3) In a sugar-mill the pestle and its appurtenances are on a much larger scale. The मोहन *mohan* is six or seven cubits long, while in an oil-mill it is seldom more than three or a half cubits, the rest in both cases being in proportion.
- (4) The names of the parts differ.

268. The hollowed wooden block forming the bed of the mill. This is generally known as कोह *kolh* or कोहू *kolhu*. The cavity in this, in which the pieces of cane to be crushed are placed, is known north of the Ganges, to the west, as खान *khān*, or in Champāran चर *gh* and to the east, कुण्ड *kund* or कूण *kūn*. In Shahabad it is known as हथ *hatha* or हथोला *hanrolwa*. In South Munger it is हथ *hānra*, elsewhere south of the Ganges हथ *handha* or हथ *handu*. Round the edge, at the top of this, a rim of mud is sometimes placed to prevent the pieces of cane falling off. This is called पौच *pinr*. An iron ring is fastened round the block to strengthen it and prevent it from splitting. This is called बान *ban*, and in Tirhut also पत्तर *pattar*, and in South Bhagalpur मर्रा *marra*.

269. An iron ring is sometimes fixed under the block to prevent it being worn away by the crushing-pestle. This is generally called कोर

morwār, with variants मोरवाह *morwāh* (North-East Tirhut), मुर्व
murwār (Shahabad and Patna), मुर्व *mur* (Gaya), मुरेरा *murera* or मुर्व
murwāri in South Munger, and चमवा *chamwa* in Sāran. The पाचक
pachar is a round piece of wood placed in the bottom of the cavi
and on which the crushing-pestle moves. रोड़ा or रोरा *rorā* is used
the smaller wedges of wood placed in the cavity above this to help
crushing the juice. These are also called चँदिया *chandiya* in Champār
and North-East Tirhut, and खोंच *khonch* to the east. In Sāran a
Champāran रौन *raun* is a canal out on the surface of the block throu
which any juice thrown up may flow back into the cavity. In Nor
West Tirhut this is called रैन *rain*, in North-East Tirhut रस
raspāin, and in South-East Tirhut खाता *khāta*.

270. The drain for the juice cut in the bottom of the block
to the north नरदोह *nardoh*; also in Tirhut नरोह *naroh*, in Nor
East Tirhut नरोही *narohi*, and in South-East Tirhut रसीड़ *raser*;
South-West Shahabad it is गुजुरवा *gujurua*, and in the rest of
district जोहा *joha* or रसवा *rasha*; in Patna it is रसवारा *rasghāra*
निरोह *niroh*; in Gaya it is हनी *chhoni*; in South Munger, चोना *chon*
and in South Bhagalpur, लरलो *larlo*.

271. The wooden spout through which the juice drops is पतन
patnāri. In the body of the block a channel is cut in which the blo
फेंटा *phenta*, of the driving gear works. This is called घनरा *gha*
in Shahabad and मँदर *māndar* in Patna.

272. The horizontal board to which the bullocks are attached
This is कतरौ *katrī*, with a variant, कातरि *kātari* or कातर *kātar*,
Shahabad, South-East Tirhut, and South Bhagalpur.

273. The upright beam or pestle which moves in the hollow of
mill and crushes the cane.—For this three names are current, viz. मो
mohan (Tirhut, except the north-west, Champāran, Patna, and Sou
Munger), with variants, महान *mahan*, in Gaya and North-West Tirh
and मोंहन *monhan* in Shahabad, लाठ *lāth* (Tirhut and Champāra
and जाठ *jāth* (Tirhut and Shahabad). The last word is used in Sār
only in reference to the oil-mill, and not to the cane-mill.

274. The ball at the end of this beam, which fits with the holl
of the block, is मुँव *mūn*, मुँवा *mūnra*, मुँवी *mūnri*. The notch abo
this is north of the Ganges and in Patna कान्ह *kānh* or कन्हा *kandha*.
North-West Tirhut it is कन्धिया *kanhiya*, and in South-East Tirh
पन्जा *panja*. In Shahabad it is कान *kān* or लंगरा *langra*. In Gaya it

CHAPTER II.—APPLIANCES USED IN THE MANUFACTURE OF SUGAR.

A.—THE CANE-MILL.

265. The cane-mill is known as कोह *kolh* or कोहू *kolhu* throughout the province. Patent mills introduced by European firms are known as कल *kal*.

266. It is apprehended that the following description of a country sugar-mill will be of little else than antiquarian interest, for such mills are fast disappearing from Bihār, being superseded by the English-made iron crushing-mill made at Bihia. To such an extent has the use of country mills died out, that the writer found it impossible to find a single one in the sadr subdivision of the Patna district which was in a fit state for a photograph to be taken of it. They had all been broken up for firewood, only a few dismantled ones being available. For a general idea as to its appearance, the reader is referred to the illustrations of an oil-mill in the last chapter.

267. The following are the principal points of difference:—

- (1) The hollow in the block has perpendicular and not sloping sides, and it is hence cylindrical, and not conical, in shape.
- (2) The sugar-mill has no रेवड़ी *rewṭi*.
- (3) In a sugar-mill the pestle and its appurtenances are on a much larger scale. The मोहन *mohan* is six or seven cubits long, while in an oil-mill it is seldom more than three and a half cubits, the rest in both cases being in proportion.
- (4) The names of the parts differ.

268. *The hollowed wooden block forming the bed of the mill.*—This is generally known as कोह *kolh* or कोहू *kolhu*. The cavity in this, in which the pieces of cane to be crushed are placed, is known north of the Ganges, to the west, as खान *khān*, or in Champāran घर *ghar*; and to the east, कुण्ड *kund* or कुंरू *kūrū*. In Shahabad it is known as हथा *hatha* or हंठोलवा *hanrolwa*. In South Munger it is हॉरा *hānra*, and elsewhere south of the Ganges हथा *handha* or हथा *hatha*. Round the edge, at the top of this, a rim of mud is sometimes placed to prevent the pieces of cane falling off. This is called पीर *pinr*. An iron ring fastened round the block to strengthen it and prevent it from splitting is बन *ban*, and in Tirhut also पत्तर *pattar*, and in South Bhagalpur मररो *marra*.

269. An iron ring is sometimes fixed under the block to prevent it being worn away by the crushing-pestle. This is generally कोरदार

morwār, with variants *मोरवार* *morwāh* (North-East Tirhut), *मुकुवार* *murwār* (Shahabad and Patna), *मुर* *mur* (Gaya), *मुरेरा* *mūrera* or *मुकुवारी* *murwāri* in South Munger, and *चमवा* *chamwa* in Sāran. The *पाचर* *pāchar* is a round piece of wood placed in the bottom of the cavity, and on which the crushing-pestle moves. *रोड़ा* or *रोरा* *roṛa* is used for the smaller wedges of wood placed in the cavity above this to help in crushing the juice. These are also called *चंदिवा* *chandiya* in Champāran and North-East Tirhut, and *खोंच* *khonch* to the east. In Sāran and Champāran *रैन* *rāin* is a canal out on the surface of the block through which any juice thrown up may flow back into the cavity. In North-West Tirhut this is called *रैन* *rain*, in North-East Tirhut *रसपैन* *raspāin*, and in South-East Tirhut *खता* *khāta*.

270. The drain for the juice cut in the bottom of the block is to the north *नरदोह* *nardoh*; also in Tirhut *नरोड़* *naroh*, in North-East Tirhut *नरोही* *narohi*, and in South-East Tirhut *रसीड़* *raser*; in South-West Shahabad it is *गुजुरवा* *gujurua*, and in the rest of the district *जोहा* *joha* or *रसवा* *rasha*; in Patna it is *रसघारा* *rasghāra* or *निरोह* *nirōh*; in Gaya it is *छोनी* *chhoni*; in South Munger, *चोना* *chona*; and in South Bhagalpur, *लरलो* *larlo*.

271. The wooden spout through which the juice drops is *पतनारी* *patnāri*. In the body of the block a channel is cut in which the block, *फेंटा* *phenta*, of the driving gear works. This is called *घररा* *gharra* in Shahabad and *मँदर* *mādar* in Patna.

272. *The horizontal board to which the bullocks are attached.*—This is *कतरी* *katri*, with a variant, *कतरि* *kātari* or *कतर* *kātar*, in Shahabad, South-East Tirhut, and South Bhagalpur.

273. *The upright beam or pestle which moves in the hollow of the mill and crushes the cane.*—For this three names are current, viz. *मोहन* *mohan* (Tirhut, except the north-west, Champāran, Patna, and South Munger), with variants, *महन* *mahan*, in Gaya and North-West Tirhut, and *मोंहन* *monhan* in Shahabad, *लाठ* *lāth* (Tirhut and Champāran), and *जाठ* *jāth* (Tirhut and Shahabad). The last word is used in Sāran only in reference to the oil-mill, and not to the cane-mill.

274. The ball at the end of this beam, which fits with the hollow of the block, is *मूँ* *mūn*, *मूँवा* *mūnra*, *मूँरी* *mūnri*. The notch above this is north of the Ganges and in Patna *कान्ह* *kānh* or *कन्हा* *kandha*. In North-West Tirhut it is *कन्धिवा* *kanhiya*, and in South-East Tirhut *पन्जा* *panja*. In Shahabad it is *कान* *kān* or *लंगरा* *langra*. In Gaya it is

मोहनम्बुका *mohanthambha*, and in South Munger डेंका *dhenka*. The upper end rounded off is चूर *chūr* or चुरिया *churiya*, or (in North-East Tirhut) मूँड़ *mūnr*; and the curved block of wood joined to this is डेंका *dhenka* or (in North Tirhut, Shahabad, and South Bhagalpur) डेंकुषा *dhenkua*, and in Sāran डेंकुषा *dhenkuha*. This curved block of wood connects the pestle with the upright post which is fixed in the horizontal driving-board.

275. This upright post is north of the Ganges, to the west, हरसा *harsa* or हरिषा *harisa*, and to the east (and in South Bhagalpur) मनिक्थम *maniktham* or मानिक थम *mānik tham*. In Shahabad it is मन्कथम *mankham*, in Patna and Gaya खूँटा *khūnta* or मरन्थम्ब *marthamb*, and मानिकथम *mānikham* in South Munger. The pieces of wood which keep the beam of the driving gear in the channel at the base of the block are जीभा *jibha* or जिभिया *jibhiya*, or in Sāran the front one is called फंटा *phenta*, and the back one कनेह *kanail* or (south of the Ganges) कनेहो *kanheli*, and in Sāran कनेहो *kanaili*. In North-East Tirhut they are called जिभिया *jibiya*.

276. A rope of straw supporting the pestle by fastening it to the upright beam is north of the Ganges, to the west, नाधन *nāadhan*, in Champāran नधना *nadhna*, in Tirhut नधान *nadhān*, but in East Tirhut लाध *ladh*. In Shahabad it is टेंडना *tanrna*, in Gaya नाध बरन्ता *nādh barta*, in Patna नाधन *nāadhan*, in South Munger नाध *nādh* or बरह *barah*, and in South Bhagalpur सारंगी *sārangi* or लेध *ledha*.

277. The bamboo strut attached to the horizontal driving-board, and running up obliquely to meet the upright post, is called north of the Ganges खरचौड़ी *kharchāuri*, or south of it कमोरा *kamora* (Shahabad), खंरचर *khanrchar* (also in Shahabad), खरचर *kharchar* or खरचाही *kharchāhī* (Patna and Gaya), कुडरिया *kudanriya* in South Munger, and खरचारो *khanrchāro* in South Bhagalpur. This is fastened to the driving-beam by a rope, called नारन *nāran* or नाधा *nādha*, or in East Tirhut लारन *lāran*.

278. The part of the horizontal beam on which the driver sits is कातरि *kātari*, कातर *kātar*, or कतरी *katri* as above.

279. The leather thong by which this horizontal beam is connected with the yoke is नाधा *nādha* or (in Sāran) कनेहो *kanheli*, (in Gaya) नाधा बरन्ता *nādha barta*, and in Patna मंज्हा *mānjha*. काद *kārā* or (in North-East Tirhut and Shahabad) काहा *kārha* is a rope which is tied to a peg in the end of the horizontal board, passed round the hump of the bullock and back again to the board, where it is tied into a hole;

and the rope passing under the bullock's chest, joining the two traces thus made, is पेटी *peti*.

280. *Miscellaneous*.—The circle in which the bullocks move has various names, viz. गोरपौर *gorpaur* (Sāran), पौदर *paudar* (Champāran and Shahabad), पौर *paur* or पौरी *pauri* elsewhere north of the Ganges, in Patna, Gaya, and South Bhagalpur, बही *bahi* also in Patna, and बहारा *barhara* in South Munger.

281. The receptacle for the cane before it is cut (generally a hole in the ground) is गेंदियारी *genriyāri* generally, and गेंदियार *geriyār* to the west. The receptacle for cane ready cut is टोमियारी *toniyāri*, with variants टोमियाही *toniyāhi* (Sāran, Champāran, and South-West Tirhut), टोमियासी *toniyāsi* (North-West Tirhut), and टोकनाह *tonkhād* (South Bhagalpur). In Shahabad it is called अंगरवार *angarwār*.

282. A wooden mallet is used for pressing the cane under the crusher. This is थापी *thāpi*; also in North-East Tirhut मिडिट *milit*.

283. The cane as it is crushed is stirred up by hand, and the man who does this is called मोरवाह *morwāh* or मौरवाह *monrwāh*, or in South Bhagalpur घनवाहा *ghanwāha*. This man sometimes drives the bullocks also, and when he does so he is still called by this name.

284. The pot into which the juice drops is called generally खोर *khora* or (in South-East Tirhut) खोर *khōr*, other local names being नाह *nād* (Shahabad) and कुण्डा *kunda* (Shahabad, West Tirhut, and Patna), or (generally) चन्ना *chhanna*. Over this is often placed a basket or earthen pot with the bottom pierced like a sieve. This is called generally चन्ना *chhanna*, रसचन्ना *raschhanna*, or चेनी *chheni*. Local names for this are तरौड़ी *tarauri* (Sāran and Champāran), चिहा *chhitta* (also in East Tirhut), or चिरगिरा *chhirhira* (Shahabad), and दलिया *daliya* (South Munger). An earthen vessel for holding the juice is in Gaya हथैला *hathaila*.

285. From these vessels the juice is removed to the boiler in a pot called कराह or कड़ाह *karāh*, or sometimes करवाहा *karāhā*.

286. The blocks on which the cane is cut are north of the Ganges and in Shahabad निसुहा *nisuha*, a variant being निसुहा *nisua* in South Bhagalpur. Other names are थेहा *theha* (North-West Tirhut), परिथेहा *pariyetha* (Gaya), कुकाठ *kukāth* (Patna), परकाठ *parkāth* (South Bhagalpur), and टोकनाहा *tonkālā* or टोकनाह *tonkat* in South-East Tirhut and Munger.

287. The hollow in the mill is in Bihār cleaned by hand while the crusher is turning; hence there is no apparatus in existence for raising the latter, as there is in Gorakhpur and Azamgarh.

288. The basket from which the mill is fed is **चैदी** *chainti* north of the Ganges, with a variant, **चौदी** *chhti*, in North-East Tirhut. In Shahabad it is **ओड़ी** *ori* (also in East Tirhut) or **खैची** *khainchi*, and in South Bhagalpur **ओड़िया** *oriya*. In Patna it is **बहा** *batta*, and in Gaya **पथिया** *pathiya*. The pieces of cane cut up ready for the mill are **गैड़ी** *genri* to the west and optionally in East Tirhut, and **टोनी** *toni* in Patna, Gaya, and to the east. In South-West Shahabad they are **अंगारी** *angāri*.

289. As much chopped cane as can go into the press at one time is **घानी** *ghāni*, and as much juice as can be boiled at one time **ताव** *tāv*. The latter is also **खेपान** *khepān* in South-East Tirhut, **पाक** *pāk* in Patna, and **रान** *rān* or **रान्ह** *rānh* in South Munger and South Bhagalpur.

290. The cane after the juice is expressed is called **खोइया** *khoīya*, with local variants **खोइया** *khoīya* (Patna, Gaya, and the east) and **खोइहा** *khoīha* in South Bhagalpur. In Shahabad it is also **खेपुहा** *chephua*.

291. To work the mill is **चेरब** or **चेरुब** *perab*, and when several cultivators take it in turns, each turn is called **भान्ज** *bhānj*, **पारी** *pāri*, or (Gaya) **पकडी** *palti*. When men work it turn by turn they are said to do it **भान्जा सिरे** *bhānja sire* north of the Ganges, **फेरा पारी** *phera phāri* in Tirhut, and elsewhere **पारा पारी** *pāra pāri*. Sometimes a mill is owned by co-sharers, and then their taking it in turns is **भान्जहरिया** *bhānjhariya*, **सजियेनी** *sajhiyāni*, or (Tirhut) **सबथेनी** *sabthāni*, and also in North-East Tirhut **सजिया** *sajhiya*. In South Munger **धेक** *dhenk* is the working of a mill by cultivators for a week in turn, one after the other, till the turn of the first comes again.

292. *The men engaged on the mill are as follows:—*

(1) *The man who cuts the standing cane.*—This man is **अंगेरीहा** *angeriha* to the west generally, **गैरुवाहिया** *genruwahiya* in the north-west, **पजुवाहा** *pajwāha* and **पगारुवाह** *pagaruwāh* or **पंगारुवाह** *pangaruwāh* in Tirhut. In Shahabad he is also **गैरुचौहा** *genrchhila*, or in the south-west of the district **खोइया** *chhōiya*; in Patna and Gaya he is **केतारपारा** *ketarpāra* (from **केतारी** *ketāri*, sugar-cane), **पारताहार** *partāhar*, or **पारनिहार** *parnihār*, and in South Munger **कतारपारा** *katarpāra* or **पतारपारा** *patarpāra*. In South Bhagalpur he is **घुरकट्टा** *ghurkatta* or **कटनिया** *kataniya*.

In Sāran and Champāran these men do their work without wages in money, their pay being the leaves of the cane which they cut, which they take home and use for cattle fodder.

293. (2) *The man who cuts the cane into lengths for the mill* is कानू *kānu* in South Tirhut and Sāran. In Champāran he is पकवाह *pakwāh*, and to the west he is गेंड़िवाहा *genrikāta* or अंगरवाह *angarwāh*. Elsewhere he is डोमकाहा *tonkatta*, with a variant, डोमिकाहा *tonikatta*, in South-East Tirhut. In North-West Tirhut he is simply called मज्जुरा *majūra*, and in North-East Tirhut sometimes जम *jām*. In Sāran and Champāran the same person cuts the cane and boils the juice, hence his name.
294. (3) *The driver of the mill* is कतरवाह *katarwāh*, with variants कतरिवाह *katariwāh* or कतरवाहा *katarwāha*, and in South Bhagalpur कतरवाहा *katarbaha*. In South-West Shahabad and in Tirhut he is called हंकवा *hankwa*.
295. (4) *The man who feeds the mill.*—He is मोरवाह *monrwāh* or मोरवाह *morwāh* generally. In Patna and Gaya he is घमवाहा *ghamwāha* or (in South Bhagalpur and South Munger) घमवाहा *ghanbaha*.
296. (5) *The man who removes the crushed cane.*—He is हलुआ *haluāi* in North Tirhut; elsewhere this is done by the man who feeds.

297. *The buildings.*—The whole manufactory, including both cane-mill and boiling-house, is called कोलुआर *kolhuār*, or in South-West Shahabad गोखौर *golaur*. In Patna, Gaya, and the east it is called कोलसार *kolsār*.

298. The house in which the cane is cut into slips for the mill is called गेंड़िवाहा *genriyār*, or गेंड़िवाही *genriyāri* to the west and डोमिवाही *toniyāri* to the east. Local varieties of this last are डोमिवाही *toniyāsi* in North-West Tirhut and डोमकाहा *tonkhād* in South Bhagalpur.

299. *Folklore on the subject.*—Near the place where the cane is cut into slips the men make a round idol of a deity called मकार बीर *makār bīr*, or in Shahabad महकार बीर *mahkār bīr*, and in North-East Tirhut महकार *mahkār*. He is said to have been originally a Dom, who once came to a sugar manufactory in the olden time and asked for juice, which the people refused to give to him. Thereupon he jumped into the boiler and was boiled to death. His spirit became deified, and is now worshipped by the workmen. The worship consists in pouring a little water on the

image when the cane is brought into the manufactory from the field, so that he may wash himself. Then five canes are put before him. They are then cut up and put first into the mill. The first juice that comes out is also poured over him, and then the rest may go into the boiler. In South Bhagalpur the deity worshipped is *बिसवकर्मा biswakarma*.

B.—THE BOILING-HOUSE.

300. This is in Sāran *गुरौर guraur*, and in Shahabad *गोलौर golaur*; elsewhere it is simply *कोल्हुआर kolhuār* or *कोल्सार kolsār* as above.

301. The fireplace is *चूल्हा chūlha*, or in South Munger *गमन्हेर gamher*. The hole through which the fire is fed with fuel is generally *मुँह muh* or *मुँह munh*, but in Patna and Gaya it is *मोहन्हा mohkha*. The hole through which the fire is raked is *साँसी sānsi* generally north of the Ganges, *नँगन्हा nangra* in North-East Tirhut, *लँगन्हा langra* in Shahabad, and *उधान udhān* in South-East Tirhut. Elsewhere it has no special name. In Sāran *लँगन्हा langra* is a receptacle for the juice when removed from the boiling-pan.

302. The outlet for smoke is *धुवाँकर dhuānkas* north of the Ganges and in Shahabad. In South-West Shahabad it is *धुंधुका dhundhuka*, in Gaya it is *हिक्का hikka*, in Patna *हिक हink*, and *नँगन्हा nengra* in South Bhagalpur and South Munger.

303. The stick used as a poker is *खोरन्नी khorni*, or in Patna *खोरन्ना khorna*. Local names are *खोदौना khodauna* (South-West Shahabad), *लहदा लahuḍāi* (Shahabad), and *अँचना anchna* (to the east). In Shahabad *फरही pharūhi*, or in the west generally *फहरी phahuri*, is a piece of wood used for raking out ashes. The man who stokes the fire is called *कान kānu* north of the Ganges and in South Bhagalpur and Shahabad. Local names are *धुरन्कमिया dhurkamiya* (South-East Tirhut), *चुल्होका chuljhonka* (East Tirhut and Shahabad), *चुल्हचहा chulhancha* (East Tirhut and Gaya), *अँचवाचा anchwācha* (Patna), and *अँचवाचर anchtāhar* (South Munger).

304. The vessel in which the juice is collected before boiling is *नाद nād* or *नादी nādi*, or (in Gaya) *चट्टी chatti*, (North-East Tirhut) *गगरी gagri* or *घैला ghaila*. Generally, however, it is kept in the *चन्ना chhanna* (see above), of which there may be several in use at one time.

305. The spoon for taking the juice out of the boiler is north of the Ganges, to the west, *कठही kathahi* or *कठखुरपी kathkharpi*, and to the east (also in Shahabad) *सेक saik* or *सेका saika*. Elsewhere south

of the Ganges it is *सफ़ाई saphai* or *सफ़ाया saphaiya*. In South-West Shahabad it is, however, *डोहरा dohra*, and in South Bhagalpur it is *दपट्टी dapti* or *दबू dabbu*.

306. The scraper to prevent the sugar resting on the bottom of the boiler is *खुरपी khurpi* generally. In Sāran and Champāran it is *खुरपा khurpa*, and in North-East Tirhut *कठखुरपी kathkhourpi*, the meaning of which here is different from that in Sāran, Champāran, and West Tirhut. In Patna it is *पेड़नी perni*, and *दपट्टन daptan* in South Bhagalpur.

307. The iron ladle used as a skimmer *पौना* is *pauna*, or (North Tirhut) *मैलखन्ना mailkhanna*, (South-West Shahabad and South Bhagalpur) *थापी thāpi* (also made of wood), and *झंझरा jhanjhra* in Patna, Gaya, and South Munger. Sometimes it is not necessarily of iron, and then it is *खुरपा khurpa* in South-West Shahabad, *हथा hatha* or *हत्ता hattha* (of earthenware) in Patna, Gaya, and South Munger, and *चनौटा chhanauta* in Saran and South Bhagalpur.

308. The boiling-pan is called *कराह, कड़ाह karāh* or *कराही karāhi*. The earthen vessel used for removing the cooked juice from the boiler is north of the Ganges *सैक saik* or *सका saika*, and in Shahabad it is *पंगौरा pangaura*; in Sāran it is *पौड़ा paunra*. The pot in which the boiled syrup is placed is called *मट्टकी matuki* south of the Ganges, also (South-West Shahabad) *ओड़ी ori*, (Gaya) *नदवा nadwa*, *खोरा khora* in the South-East, and *कुंरी kūnri* in South Bhagalpur.

309. *नाद nād* is a hole in the ground dug for receiving the coarse sugar. North of the Ganges it is also *पौड़ा paunra* or *पौड़ी paunrhi*. The sugar is collected and thrown into this with a bamboo fitted at one end with a roller, which is called *गुरदम gurdam* or (in South-West Shahabad) *गुरदम gurdan*. In Tirhut it is also called *दबकन dabkan*, and in South-East Tirhut *सपई sapaī*.

310. In North-East Tirhut *माट māṭ* or *कोठी kothi* is the large vessel in which the juice is finally coagulated. These are in Tirhut *गुरपौर gurpaur*, and in Champāran (made of sun-baked earth) *देहरी dehri*.

311. *राब rāb* is undrained raw sugar, and *गूर gūr* is *rāb* boiled down for a longer time. Further particulars concerning these and the other products will be found in the chapter relating to sugar-cane (§§ 1014, 1015).

O.—THE SUGAR REFINERY.

312. A sugar refinery is known as चीनी के कारखाना *chini ke kar-khāna* or चीनी के गोदाम *chini ke godām*. South of the Ganges the word खंवर *khanrsār* or खंवरारी *khanrsāri* is also used. The house in which the sugar is refined is called चूल्हा के घर *chūlha ke ghar* or काराह के घर *karāh ke ghar*. In South Bhagalpur it is बहा *bhattha*.

313. In making coarse sugar (काँची चीनी *kānchi chini*), a vat, a drain, a reservoir, and a treading-floor are used.

314. The *vat* is in Shahabad चौद *haud* or चौदी *haudi*, in Gaya चबबचा *chahbachcha*, in Patna खंवरगर्ना *khanrgarna*, and in South Bhagalpur गुरहण्डी *gurhandi*. North of the Ganges and in Gaya it is नाद *nād* or नाँद *nānd*.

315. The *drain* is नाली *nālī* or नारी *nāri*, or in South Bhagalpur कारवा *karha*. In Saran it is also called खाना *khāta*.

316. The *reservoir* is north of the Ganges, and optionally in Shahabad, नाद *nād* or नाँद *nānd*. In Shahabad it is डोभा *dobha*, in Patna चौद *haud* or चरवा *charua*, and elsewhere south of the Ganges चबबचा *chahbachcha*.

317. The *treading-floor* is पहा *patta* north of the Ganges. South of it, it is in Shahabad पाटा *pāta*, in Patna and Gaya चबबत्रा *chabuttra*, and to the east चट्टी *chattī*.

318. In making regular sugar or सक्कर *sakkar*, the drain and the reservoir are used as before. The bundles (मोटरी *motri*, or in Patna नारंगी *nārgī*, in Gaya थैया *thaiya*, and in South Bhagalpur गजा *gāja*) of sugar are tied up in cloths [लोथा *lotha* or (in Patna and Gaya) खलना *chhalna*], placed on a bamboo framework and pressed with weights of stone or sun-dried clay. The framework is called north of the Ganges खँच *khānch* or खँचा *khāncha*, or (in Champāran and East Tirhut) हँडा *chhainta*. In Shahabad it is डटरी *thatri* or टिकडी *tikthi*, in Patna and Gaya टेकडी *tekthi*, and in South Bhagalpur खँचरी *chānchri*. The weights are चाम्पा *chāmpa*, or, when made of stone, पथल *pathal*, or in Saran थापी *thāpi*.

319. The following *utensils* are used in the boiling-house :—

- (a) An iron boiler, काराह *karāh*, काराहा *karāha*, or काराही *karāhī*. When an earthen boiler is used, it is called खपरा *khapra* or खपरी *khapri*, or in South-West Shahabad and East Tirhut अथरी *athri*.

- (b) An iron ladle for removing the scum. This is चमौटा *chhanauta* or पौना *pauna*, also in Patna and Gaya जंजरा *jhanjhra*.
- (c) An earthen pot with holes in it, used as a filter, नाद *nād* or नंद *nānd*. In South-West Shahabad it is ठेंडिवाड नाद *thenthivāḍ nād*.
- (d) A filter of river grass, known as सेंवार *semwār* or सेवार *sewār*, or in North-East Tirhut सेमार *semār*.
- (e) A scraper for removing the layer of clean sugar. When made of shell it is called सितुषा *situa*, or in South-West Shahabad सितुषा *situha* or सुतुषा *sutuha*. A curved knife used for the same purpose is सिहोरनी *sihorni* in Sārān and Champāran, सेहोरना *sehorna* in Shahabad, and सोहरना *sohorna* in North-East Tirhut.
- (f) The filtering-basket for cleaning the same is खँचा *khāncha* or खँची *khānchi*. In Gaya it is डलवा *dalwa*, and in the east also देही *deli*.
- (g) The wooden or iron ladle for cooling the boiling syrup is north of the Ganges तामिया *tāmiya* or (in Sārān and North-East Tirhut) तमिया *tamiya*. South of the Ganges it is डबू *dabbu*, (in Shahabad) गुरन्दन *gurdan*, or in South Bhagalpur जंजरा *jhanjhra*.
- (h) The iron stirring ladle used for taking syrup from the boiler and larger than the last is तामा *tāma* north of the Ganges; in Shahabad it is खुरचनी *khurchani* or दोहरा *dohra*; in Patna and Gaya it is चोलनी *chholni*; and in South Bhagalpur दोहरा *dohla*.
- (i) The earthenware jug for pouring the syrup into the boiler is सैका *saika*, also हत्था *hattha* in Patna and Gaya, and पंचनी *panchni* in South Bhagalpur. A larger jug of the same kind is निमड़ा *nimra* north of the Ganges, and निबड़ा *nibra* or परन्हा *parchha* south of it; also तौला *taula* in the east.
- (j) The wooden supports of the filter are north of the Ganges खामा *khāta*, or खँटा बला *khūnta balla* south of the Ganges. They are in Shahabad सिही *sirhi* (also in South Munger) or तिरपार *tirpāi*, and टेपार *tepāi* in South Bhagalpur. In Patna and Gaya they are made of earth or brick, and are called गोड़ी *gori*.

- (k) The shovel for stoking the fire is फरुही *pharuhi* or फहरा *phahura* in Sāran and Champāran, and फरुहा *pharuha* or कोदारी *kodāri* in East Tirhut. In Shahabad it is फरुमा *khormā*, or in the south-west of the district फरुसा *pharsa*. In Gaya it is फरुनी *karhni*, in Patna फरुगना *agkarhna*, and in the east फरुकुल *karchkul*.
- (l) The ladle for stirring the hot syrup in the cooling pan is तमियाँ *tamiyān* north of the Ganges and तंबिया *tambiya* in Shahabad. In South-West Shahabad it is डबू *dabbu*, in Patna and Gaya घटना *ghatna*, and in the east also दाबा *dāba*.
- (m) The piece of matting or cloth in which the sugar is dried in the sun is पास *pāl*, also in South-West Shahabad पाटा *pāta*, in Gaya टप्पर *tappar*, in Patna टाट *tāt*, and in South Bhagalpur चट्टी *chatti*.
- (n) The flat wooden pans for cooling the syrup are कठौता *kathauta* or कठौती *kathauti*, also in the east कठौत *kathaut*, and in Sāran कठवत *kathvat*. In Sāran and Champāran they are नाद *nād* or ओसौनी *osauni*.
- (o) The vessel into which the juice drops as it is filtered is परुसा *parchha* or (North-East Tirhut and Shahabad) तौला *taula*.

CHAPTER III.—APPLIANCES USED IN THE MANUFACTURE OF INDIGO.

320. Indigo manufacture is confined almost entirely to North-Gangetic Bihār.*

321. The indigo beating-vat is मचर के चौद (or चौद) *mahāi ke hauj* (or *haud*), and also in North-East Tirhut मचनिया चौद *mahaniya haud*. The water reservoir is खजाना *khajāna*. The upper or steeping-vat is बोहार के चौद *bojhāi ke hauj*, or in East Tirhut बोभनिया चौद *bojhaniya haud*. The rake for agitating the fermented liquor is फहरौ *phahuri* in Sāran and फरुहा *pharuha* elsewhere. In North-East Tirhut it is also फरुमा *pharma*.

* The author is indebted to W. B. Hudson, Esq., for much of the information contained in this chapter. The system of manufacture described is the old style, now only used by natives. In European factories the use of steam power has made considerable changes.

322. The beams of wood for pressing the plant are दबौडा *dabauta* in Sāran and Champāran, सहनौर *sahtir* in Tirhut and Sāran, दाब *dāb* or धरन *dharan* in North-East Tirhut, and बीम *bim* in South-East Tirhut. These are supported on projections in the walls of the vat, called मजूसी *majusi*, or in Champāran तान *tān*. In East Tirhut they are called सिरपाहा *sirpāha*. Under these pressing-beams are placed, बल्ल *ballal*, or in Sāran कैच *kainch*, which are bamboos laid immediately on the top of the plant.

323. The हौदरी *haudri* (Sāran and South Tirhut) or माल मजूरी *māl jhari* (Champāran and North Tirhut) is the small reservoir where the indigo juice collects to be taken to the boiler. The drain is नाली *nāli* or नारी *nāri*, or in Sāran मोरी *mori*, and the डेकन *chhekan* is the door by which it is closed. The strainer is चहना *chhanna*, or in South-West Tirhut चहर *chaddar*.

324. The boiling-room is कराच घर *karāch ghar*. The मेज *mej* is the wooden or masonry straining table in which the indigo is put after being boiled. This is the name in Sāran, Champāran, and West Tirhut; to the east it is बालू मेज *bālu mej* or (in South-East Tirhut) माल मेज *māl mej*.

325. The पीरिस *pirich* or पीरिस *piris* is a corruption of the English word "press," in which the boiled liquor is placed in a cloth and the water pressed out. In Sāran दाला *dāla*, and elsewhere चलना *chalna*, are the perforated boards placed above and below the indigo in the press. The screw of the press is पेंच *pench*. The square boss or nut on it is डिबरी *dhibri*. The मोरनी *morni* is the spanner or apparatus for turning the screw. In South-East Tirhut it is also मनोरनी *mamorni* or पेचकस *pechkas*. The large wooden beam through which the screw passes is टेथा *theha* in Sāran, and elsewhere दबौडा *dabauta* or दाब *dāb*; when it is made of iron it is called in South Tirhut बैंक *bānk*. The कुटका *kutka* are small pieces of wood placed below and above the दाला *dāla* or चलना *chalna*.

326. The machine for cutting cakes is फरना *pharma*, and the wires with which they are cut तार *tār*.

327. The cakes of indigo are गोडी *goti*, and they are dried in a drying-house, गोडी घर *goti ghar*, on shelves, called in East Tirhut मचान *machān*, and elsewhere चाली *chālī*.

328. The following are among the implements used in indigo agriculture:—

- (1) The धर्म लगी *dharm laggi*, a wheel for measuring land, each revolution of which covers one लगी *laggi*.
- (2) The कुदर *kudār* or कुदरि *kudāri*, a mattock for digging.
- (3) The हार *har* or plough, which is of two kinds—
 - (a) बिलाष्टनी *bilāṣṭī*, or English plough.
 - (b) देसी *desi* or कठौर *kathaur*, the country plough.
- (4) टॉड़ी *tānri*, the drill plough.
- (5) कन्टा *kanta* or खखोरनी *khakhorni*, the rake or harrow.
- (6) खुरपी *khurpi*, the spud for weeding.
- (7) हंसु *hānsu* or हंसुआ *hansua*, the sickle for cutting the plant.

CHAPTER IV.—THE SPINNING-WHEEL.

329. The following diary shows the process of spinning thread and making cloth in the subdivision of Madhubani, in North-East Tirhut, in the year 1879:—

On the 20th September the writer bought 24 *ser*s of cotton, being a day's plucking on a sunny day from about a bigha and a half of cotton field. The cotton बाँगा *bānga* (see § 1016 for the various names and varieties) was of the kind called कोकट्टी *kokti*, which ripens in the month of *Bhādon* (August-September). It was pulled out of the husks from the tree.

20th—26th September.—During this time the cotton has been drying in the sun, and now (26th) two old women are employed to clean it, picking out the dirty and immature cotton, called कर्कट *karkut*. This is principally composed of seeds which have come to nothing and been worm-eaten. This cleaning is done by hand. It lasted to the 30th September.

1st October.—Commenced to separate the seeds, बाँगा *bānga*, from the बाँगा *bānga*. This is done by a machine called चर्की *charkhi*, which consists of two rollers, about an inch thick, of hard wood tightly wedged one above the



THE SPINNING-WHEEL (CHARKHA).

in Bahary Dass Student Govt. School of Art, Calcutta.

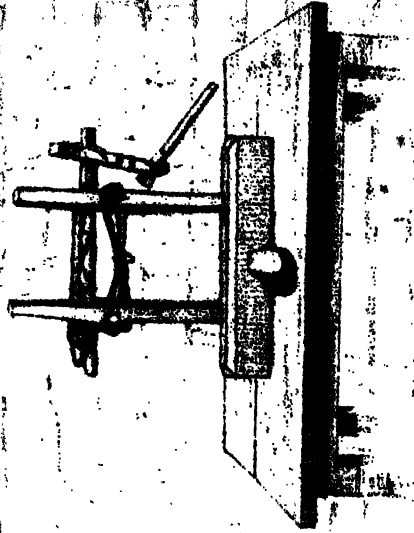

MACHINE FOR CLEANING RAW COTTON (CHARKI)

Printed by Abdul Rehim Govt. School of Art, Calcutta.

other; both rollers are supported in uprights, the ends passing through. At one end the lower roller is turned by a handle, and has at the other end, where it projects from the upright, a screw cut in it. The same end of the upper screw has a reversed screw cut in it, and these two screws fitting into each other act like cog-wheels; but when the lower roller is turned, the upper roller turns in the direction reverse to that of the lower one, so that they act as a pair of feeders tightly wedged together. The **बाँगा** *bānga* or uncleaned cotton is then applied to the feeding side of the two rollers, and on the handle being turned the cotton is pulled forcibly through by their revolution, while the seeds remain behind and fall down to the ground.

330. The two upright standards are called **खूँटा** *khūnta*, and each of the rollers **जाठि** *jāthi*, or in Sāran **सँझारी** *sanjāri*. Underneath the rollers is a cross-bar, called **कल** *kal*, joining the two uprights and holding the machine together. The **खूँटी** *khūnti* is a wedge going through each upright from front to back, under the cross-bar and holding it and the roller in their places.

331. The **पचरी** *pachri* are the wedges running sideways through each upright and tightening the two rollers together. The crank which turns the lower roller is called **मकरी** *makri*, and it is held to it by the **किल्ली** *killi* or lynch-pin. The handle at the other end of the crank, which is held in the hand, and by which the machine is turned, is called **लागनि** *lāgani*, or in Sāran **चालौनी** *chalauni* and in Gaya **हथौरी** *hathauri*.

332. The base of the machine in which the uprights rest is called **पीड़ा** *pīṛha*, or to the west **पिड़िया** *pīṛhiya*, and out of this projects behind, along the ground, the **मज्जा** *majhwa*, on which the foot of the operator is placed to keep the machine steady.

333. The cotton, when cleaned from the seeds by this machine, is called **रू** *rū*, **रूँ** *rūi*, or **तूर** *tūr*,—the last by women of the upper Hindu castes, and the two first by Musalmāns and low-caste Hindus. **रूँ** *rūi* is used in Shahabad.

334. The above lasted three days. It was then again cleaned (**तूनब** *tūnab*, **तूँब** *tūnnab*, or (in Shahabad) **तूमब** *tūmab*, to clean), the few remaining pieces of husk, &c., being picked out by hand.

21st October.—The cotton was to-day put out in the sun preparatory to being carded (बूनब *dhūnab*, to card).

22nd October.—To-day two cotton-carders (धुनिया *dhuniya*) came to card the cotton. Each brought with him a machine, called a धुनकी *dhunki*, or to the west धनुही *dhanuhi*. In Gaya it is धुनेठी *dhunethi*, in South Munger and South-East Tirhut धुनेठ *dhunaith*, and in South Bhagalpur धुनहठ *dhunhath*.

335. It is composed of the following parts :—

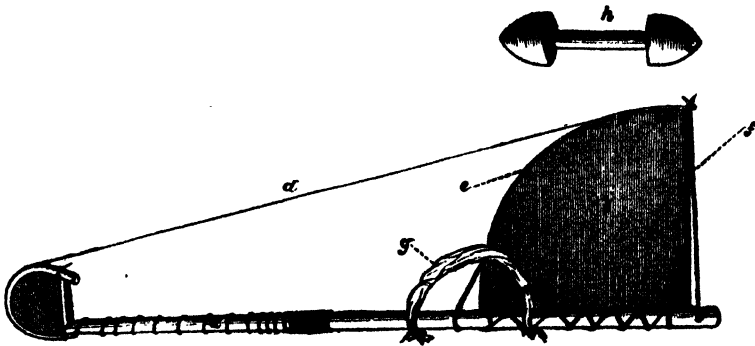

- (a) The flexible piece of wood acting as a bow, called दन्ती *danti* or दन्टा *danta* to the east and दंरी *dānri* to the west.
- (b) A broad wooden board, called फरेहा *phareha* in North-East Tirhut. In South-West Tirhut it is फरौटा *pharauta*, in South Bhagalpur फरुहा *pharuha*, and elsewhere as फरहा *pharha*.
- (c) The bridge over which the string is passed, मांगी *māngi*. In Shahabad and also optionally in East Tirhut it is माथा *mātha*, in South Bhagalpur मधवा *mathwa*, and in South Munger मगवाची *magwāsi*.
- (d) A leather string, called तान *tānt*. In Patna and Gaya it is also called रोदा *roda*.
- (e) A leather strip acting as a sounding board, lying along the round edge of the फरेहा *phareha*, on which the string rebounds, called पुचेठ *puchhet* or पुचेठा *puchheta* generally,



A Cotton-carder (Dhuniya) at Work.

Lith. by Hem Chander Ghosal, Student Govt. School of Art Calcutta

पक्षौटा *pachhauta* in Tirhut, and काँकर *kānkar* in Sāran and Champāran. In North-East Tirhut it is पुश्ताइल *pushtail*, and an optional name in Shahabad is पुक्षौटा *puchhauta*.

- (f) A stout leather string along the outer side of the फरेहा *phareha*, to one end of which the तान *tānt* is attached, while the other end is fastened to the दण्डी *danti*. It is used to tighten the तान *tānt*, and is called घिरन्ची *ghirchi* or घुरन्ची *ghurchi*. When pegs are used for tightening this, they are called बीरी *biri* or बिरिया *biriya*.
- (g) The हथकर *hathkar*, हथगर *hathgar*, or हथकर *hathkar*, is a loop of string under which the left hand is passed to hold the machine steady. The above is the name current in North-East Tirhut. South of the Ganges it is also called हथकर *hathkar*, with variants हथकरड *hathkar* or हथकरडा *hathkara* in Shahabad. In North-West Tirhut it is हथगर *hathra*, in South-West Tirhut and Sāran हथा *hathā*, and in Sāran and Champāran मुथवारा *muthwāra*.
- (h) The mallet for twanging the bow, of wood, shaped like a dumb-bell. It is held in the right hand, and the तान *tānt* is struck and twanged with it. It is called जिस्ता *jista*, and also (in Tirhut and South Bhagalpur) दिस्ता *dista*. In Patna it is called दस्ता *dasta*, and in South Mūnger दिस्ता *distha*.

336. In using this instrument it is held by the left hand under the हथकर *hathkar*, which passes over the wrist, and the तान *tānt* twanged the midst of the cotton by the जिस्ता *jista*, which is held in the right hand. This process loosens the texture of the cotton, and causes all the dust and dirt to fly out of it. The धुन्की *dhunki* is not allowed to rest on the ground, but is supported in the air by the हथकर *hathkar* passing over the wrist, and it springs up and down as the तान *tānt* is twanged.

337. The whole pile of cleaned cotton was called गोठी *gothi*. While this was going on, two old women were called in to make little hollow balls of cotton to be made into thread. They are called to the east पानी *pāni*, and to the west पिउनी *piuni* or पेवनी *pevni*. A local name in East Tirhut is पीर *pīr*. These are about four inches long and a quarter of an inch thick. A lump of clean cotton, the size of a walnut, is put on a thin skewer, called पिंरसरि *pinrhasari*, and is then rolled on a board, called पिदिहा *pirhiya*, with the palm of the hand. These are then tied up in bundles of about ten each, called मुत्की *mutki*.

338. These **पीनी** *pīni* are now ready for being made into thread in the spinning-wheel.

339. The spinning-wheel is **चरन्वा** *charkha*, but in South-West Shahabad it is **रखन्वा** *rahta*, and in the south-east **जरन्वा** *jarkha*.

340. Its parts are as follows :—

The foundation.—This is in the shape of a double letter T : thus—

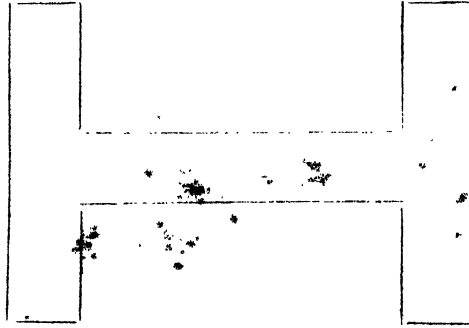

341. On one of the cross-pieces the driving-wheel stands, and on the other the spinning apparatus. This foundation is called **पीड़ा** *pirha* or **पिड़िया** *pirhiya* to the east, and **पिड़र** *pirhar* to the west. The connecting bar between the two cross-pieces is **मंजवा** *manjhwa* or **मंजा** *manjha*, in Patna and Gaya it is **लखनोरा** *lakhora*, and in South Bhagalpur **मनज्हार** *manjhāi*.

342. *The driving-wheel.*—The supports of the driving-wheel are called **खंडा** *khūnta*. The wheel itself is composed of two parts,—

(a) The central boss or nave, and

(b) The four spokes on each side of the nave.

343. The nave is called **मूरी** *mūri* or **मुरी** *muri* south of the Ganges, and **मूरी** *mūri* or **मुरिया** *munriya* north of it; in East Tirhut it is also **तामा** *tāma*, and in South Bhagalpur and South Munger **पैला** *paila*. It is about 5 inches long and 4 inches thick.

344. There are four spokes lying across each end of the nave from one circumference to the other; there are therefore eight radii on each side, and they are so arranged that the radii on each side are not opposite each other, but alternate. Each of these cross spokes is called **पुती** *puti* or **पुनी** *pūti*, or in South-West Shahabad **कमरी** *kamri*; sometimes they are also called **खंडा** *khūnta* or **खंडी** *khūnti*.

345. These spokes are held in their places by a string, called **अवाल** *awāl* to the west, **आवाल** *amwāl* in Patna and Gaya, and **अमाल** *amāl* or **अमाल** *amāl* to the east. In South Munger it is **अमहल** *amhāl*. This string goes round the extremities of each radius of each side alternately: thus—

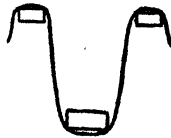

It forms therefore a kind of edge or rim of a broad wheel, something like a paddle-wheel, and over it passes the driving-band which turns the spinning apparatus. This paddle-wheel is about a foot in diameter and five inches thick.

346. The central axle of the driving-wheel is called **लाठ** *lāth* generally north of the Ganges and in South Bhagalpur. In Tirhut it is called **जाठ** *jāth*, and in North-East Tirhut also **लारठ** *lāth* or **जारठ** *jāth*. South of the Ganges it is generally **बेलना** *belna*. It is caused to revolve by a crank end called **मकरी** *makri*, or in Shahabad and West Tirhut **नाक** *nāk*. It is **दाही** *dāhi* or **दहिवा** *darhiya* elsewhere south of the Ganges, except South Bhagalpur, where it is again **मकरी** *makri*. To this is attached a handle, called to the west and in Gaya **चलौना** *chalauna*, and to the east **लरना** *larna* or **लारनि** *lārani*. In South-West Shahabad it is called **भौन्ती** *bhaunti* or **भौन्त** *bhānt*, and in Saran optionally **चलौनी** *chalauni*.

347. The driving-band is called **माल** *māl* or **माल** *māl*. It is rubbed with rosin (**धुमन** *dhūman*) and oil (**तेल** *tel*), and is then blackened with charcoal (**कोयला** *koela*). The driving-band goes twice round the driving-wheel and the spinning-axle, once passing through the **मालकाठी** *malkāthi* (*vide post*), and once not.

348. The spinning apparatus.—We now come to the spinning apparatus. There are three perpendicular uprights. The two outside ones are called **खौन्ती** *khānti*, and the middle one is called **मालकाठी** *malkāthi*. In Patna these three uprights are called together **पचकठिया** *achkathiya*, and in South-West Shahabad **खुंटिपुत्ती** *khuntiputti*. The two outside ones support the bearings of the spinning-axle, and the

centre one has in its length, facing the driving-wheel and going right through its thickness, a long slot cut. One of the strings of the driving-band passes through this slot, and the other passes outside it, so that the double turn round the spinning-axle can never get jammed up together, and so entangled.

349. On the two outside uprights, on the side furthest from the driving-wheel, project two stiff pieces of leather, called चमरक chamrakh. These form the bearings of the spinning-axle, which passes through them.

350. *The spinning-axle.*—This is called टकुवा takua, and also to the west टेकुवा tekua. It is an iron skewer about 8 inches long and an eighth of an inch thick at the thickest part. It projects a distance of three inches beyond its bearing on the same side as the handle of the driving-wheel. This bearing has on each side two little pieces of wood fitting on to the spinning-axle, which act as washers, and are called चुची chhuchhi. Outside the outer washer on the spinning-axle is a flat disc called फिरकी phirki, and two and a half inches of the axle project beyond it.

351. The driving-band, after passing twice round the driving-wheel, passes through the मलकाठी malkāthi, then twice round the spinning-axle, and then back to the driving-wheel outside the मलकाठी malkāthi; and it is evident that even the slow turning of the driving-wheel will make the spinning-axle revolve at a very high speed indeed.

352. In spinning, the projecting point of the spinning-axle has a short length of thread attached to it, and then, while the handle of the driving-wheel is turned with the right hand, a roll of cotton (पीनी pīni) is held in the left hand between the finger and thumb, and the cotton, being quickly caught up by the length of thread, is drawn off in the shape of thread on to the quickly revolving spinning-axle.

353. When the projecting point of the spinning-axle is filled with thread, the whole is called a कुकरी kukri, or in Saran कुकुरी kukurhi, and is wound off on a winder, called परन्ता parta or परेता pareta. It is also called in South-West Tirhut नटवा natwa, and in East Tirhut लटवा latwa or नटवा natwa. In South Bhagalpur it is called नटरी natai. This is like an ordinary silk-winder. The handle (चलावा chalaava) of the driving-wheel is taken out of its socket in the crank (मकरी makri), and in its place is placed one end of the axle of the winder. The other end is held in the right hand, and is revolved between the finger and thumb. The winder

conical in shape, and does not need further description. It will hold half a quarter of a *ser* of thread at a time. When it is led, the thread is taken off and tied in hanks. These are generally *पला* *pola*, *पोली* *poli*, or *पोलिया* *poliya*. Local names are *नत्ती* *natti* (North-East Tirhut), *लत्ती* *latti* (Patna and Gaya), and *करन्ची* *karchi* (South-West Shahabad).

354. The diary breaks off here temporarily, as the spinning of this particular cotton was not done in the writer's presence. He wished the thread to be spun as fine as possible, and as this could only be done by Brāhmani women, who would not come to a strange house, this part of the work was done by them at home.

CHAPTER V.—THE WEAVER'S LOOM.

355. The following is a continuation of the same diary.

18th January 1880.—The skeins of fine thread were brought to me to-day, and were put in water to soak for eight days. This strengthens it.

27th January.—After they had soaked this period I sent for a weaver. A Muhammadan weaver is *जोलाहा* *jolha* or *मोमिन* *momin*, and a Hindu weaver is *तंतवा* *tantwa* or *तंतू* *tānti*, or, in Shahabad *तंतो* *tānto*. Sometimes the Hindi word *जोलाहा* *jolāha* is used instead of *जोलाहा* *jolha*.

356. The Musalmān weaver or *जोलाहा* *jolha* is the proverbial fool of Hindu stories and proverbs. He swims in the moonlight across fields of flowering linseed, thinking the blue colour to be caused by water. He hears his family priest reading the *Qurān*, and bursts into tears at the gratification of the reader. When pressed to tell what affected him most, he says it was not that, but the wagging beard of the old gentleman so much reminded him of a pet goat which had died. When forming one of a company of twelve he tries to outcount them, and finding himself missing wants to perform his own funeral obsequies. He finds the rear peg of a plough, and wants to set up farming on the strength of it. He gets into a boat at night, and forgets to pull up the anchor. After rowing till dawn he finds himself where he started, and concludes that the only explanation is

that his native village could not bear to lose him, and had followed him. If there are eight weavers and nine *hukkas*, they fight for the odd one. Once on a time a crow carried off to the roof of the house some bread which a weaver had given his child. Before giving the child any more he took the precaution of removing the ladder. Like the English fool, he always gets unmerited blows. For instance, he once went to see a ram fight and got butted himself, as the saying runs:—

करिगह बाड़ तमासा जाब
नाहक चोट जोलाहा बाब.

Karigah chhār tamāsa jāy,
Nāhak chot jolāha khāy.

—‘He left his loom to see the fun, and for no reason got a bruising.’ Another story (told by Fallon) is, that being told by a soothsayer that it was written in his fate that his nose would be cut off with an axe, the weaver was incredulous, and taking up an axe kept flourishing it, saying *बौ करवा तः जोड़ कांड-बौ, बौ करवा तः बाब कांड-बौ, और बौ करवा तब ना-*, *yon karba ta gor kāṭbon, yon karba ta hāth kāṭbon, aur yon karba tah nā-*, —if I do so I cut my leg, and if I do so I cut my hand; but unless I do so my no—, and his nose was off. A proverb *जोलाहा जाबदि जौ काटे jolha jānathi jau kātai*,—does a weaver know how to cut barley,—refers to a story (in Fallon) that a weaver, unable to pay his debt, was set to cut barley by his creditor, who thought to repay himself in this way. But instead of reaping, the stupid fellow kept trying to untwist the tangled barley stems. Other proverbs at his expense are *कौषा बसल बाब के, जोलाहा बसल बाब के kaua chalat bās ken, jolha chalat ghās ken*,—the weaver went out to cut grass (at sunset), when even the crows were going home; *जोलाहा सुनिएलाच नीसी खेत jolha bhutiailāh tisi khet*,—the weaver lost his way in the linseed-field, an allusion to the swimming exploit already recorded. His wife bears an equally bad character, as in the proverb *बाहसलि जोलाहिनि बापक हाँदी जोचे bahsali jolhini bāpak dānrhi noche*,—a wilful weaver’s wife will pull her own father’s beard.

357. The weaver proceeded to set up in the ground seventeen pairs of sticks in two lines, at a distance between each pair of about one and a quarter cubits, and between the lines of about two cubits. At each end of each line a stout bamboo post is fixed, and close to each of

use at one end another smaller staff. Round these sticks the thread is twisted as follows :—

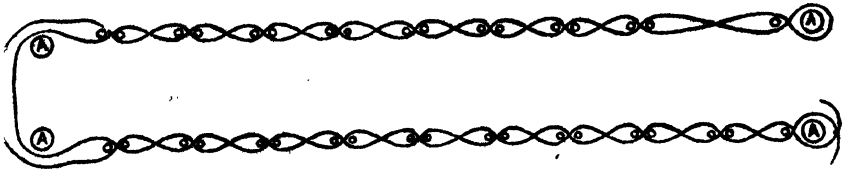

A, A, A, are the tops of the bamboo posts, and the dots are the tops of the smaller sticks.

358. This operation of setting the warp is called तानी करव *tāni-rab*, or in Shahabad ताना करव *tāna karab*. The bamboo posts are called खूंटो *khūnti*, and each stick, सर *sar*. These last are called in Iran, Champāran, and North-West Tirhut सरका *sarka*.

359. The sticks immediately in front of the bamboo posts are called the west चिहवा *chhitua*, in Shahabad चिपकी *chhipki*, and to the east टकी *chhitki*, also in North-East Tirhut डोरीक सर *dorik sar*. The whole apparatus is called तानी *tāni*, or in Shahabad ताना *tāna*, and the thread to be stretched is put on a kind of pyramidal reel called चरकी *sarkhi*. It spins on a spindle, called दग्नी *dagni*, or in Shahabad दाँगी *daṅgi*, and in the inside of the apex of the cone is a cup called थोड़ी *thori*, or in Shahabad थोहरी *thohri*, in South Munger थोहली *thorli*, and in South Bhagalpur थोरे *toi*, which rests on, and revolves on the point of the spindle: thus—

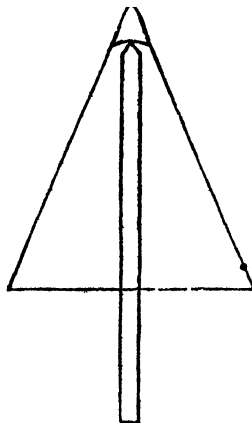

360. The spool is composed of 14 slips of bamboo, forming the framework of the cone, fastened at equal distances round the circum-

ference (चक्र *chakkar*) of the base of the cone, and converging to a point at the top.

361. The spindle of the spool is held in the left hand, and the weaver walks up and down between the two lines of thread, directing the thread by a hook called खूंड़ी *khūnri* or खोंड़ी *khonri*, or in South-West Shahabad खुडा *khunda*, in South Munger खुण्डी *khundi*, and in North-East Tirhut and Shahabad खूंड़ा *khūnra*, and shaped as follows :—

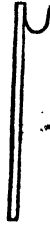

The hook at the top is made of iron.

362. 5th February 1880.—The warp having now been all set upon the sticks (सर *sar*), they were, with the खूंड़ी *khūnri*, pulled up, rolled up, and put by till to-day. To-day they were unrolled and laid out in a long line on the grass. The खूंड़ी *khūnri* were then carefully drawn out, and a bamboo staff, called सिरार *sirār* (or सिरारि *sirāri*), put in the place of each. It will be remembered that the सर *sar* were in pairs, and that at each pair the thread crossed thus  Another kind of

सर *sar* is now taken, made like a long shallow bow, except that the string is made of a thin strip of bamboo. This bow is called सुतरी *sutri*, or in Tirhut बन्हाका *banhka*. The arch of the bow is also made of bamboo. The bamboo string is called डोरी *dori*. The arch of the bow is now passed through the threads where one of the old सर *sar* was, and the bamboo string through where the other सर *sar* of the pair was, so that the cross of the threads is still preserved. The bow and string are then fastened to each other at

each end. The arches of the various bows all face one way. The warp is then laid out on the ground, and the threads neatly spread out upon the bows in parallel lines, to the width of the future piece of cloth.

- 362A. 9th February.—The thread thus arranged was rolled up, dipped into, and well wet with cold rice-water (मौद *mānr*), to which some मरुआ *marua* seeds had been added to stiffen it. It was then unrolled and stretched out horizontally at a height of three feet from the ground and brushed with a large brush, called कुँच *kūch*, dipped in mustard oil and water, which smooths the threads and takes away any knots or inequalities in the thread. This brush is also called मज्जा *majna* in West Tirhut, मँजा *mānja* in South Bhagalpur, and मँजन *mānjan* in South-West Shahabad. The cross sticks on which the thread rests are called मँजा *mānja*, and the cross bamboos at each end are ठेंगनी *thengni* or लाठी डोर *lāthi dor* to the west, गोड़ा *gora* to the east, खसराया *khasraiya* in North-West Tirhut, धाठा *dhattha* also in North-East Tirhut, धँठा *dhānta* in South Bhagalpur, and लाठी *lāthi* also in South-East Tirhut. This brushing is hard work, and takes eight men to do it properly. The brushing is along the threads, and not across them. The bristles of the brush are made of खसखस *khaskhas*, called also in Saran कसरा के जड़ *katra ke jar*, such as is used for tatties, and are about two and a half inches long. The brush itself is about a foot long and two inches wide. The brushing went on for three days, and is called पार करब *pāi karab*, and also in East Tirhut तासन करब *tāsan karab*. The phrase पार पार *āi pāi* means the brushing and other preparations, and there is a proverb, जोड़वा के पार पार, चमरा के बिधान *jolha ke āi pāi, chamra ke bihān*,—when a weaver says the cloth will be soon ready, as he is now brushing it, don't believe him, any more than you believe a shoemaker who says 'the boots will be ready to-morrow.'

362. When this was concluded, the threads were put into the loom and woven at the rate of a yard a day. The loom is little different

from that used in England. It is called करिगढ़ *kariyah* to the west and करगढ़ *kargah* to the east. It consists of the following parts:—

- (1) The *shuttle*.—This is धरकी *dharki* in Gaya and to the west, and कपरबिनी *kaparbinni* or कपरबीनी *kaparbini* to the east. In North-East Tirhut it is also called कपरनी *kaparni*.
- (2) The *needle* inside the shuttle, on which the thread is wound, is तिररी *tiri*, and the tube which revolves on this छुछी *chhuchhi*, or in Shahabad छुछी *chhunchhi*. When thread is wound on this tube the whole is called नरी *nari*, also in East Tirhut लारी *lari*. This is held in its place in the hollow of the shuttle by a pin made of a feather. This is called पखनरी *pakhnari* to the west and in South-East Tirhut, बीर *bir* in South Bhagalpur, and पखबीर *pakhbir* or पखेपारी *pakheari* to the east. A weaver estimates his work by the number of नरी *nari* which he uses up, as in the proverb in which he is supposed to address a man who has seized him to carry a load, डँगवड नऽ डँगव, नहिँ नऽ नौ नरीक चरन्कति चोपत *tangbah ta tangah, nahin ta nau narik harkati hoet*,—if you must load me, load me quickly, otherwise the time of nine shuttles will be wasted.
- (3) The *wooden frame* suspended from the roof, which after the shuttle passes is pulled forward by the weaver and drives the thread home. This is हथा *hatha* or हत्था *hattha* in West Shahabad, Patna, and West Tirhut, कामहँड *kamhanr* in the west generally, कामहर *kamhar* in the north-west, and कामहन्दा *kamhanda* in Gaya. In North-East Tirhut it is ताना *tana*, and in South-East Tirhut तानी *tani*. In South Bhagalpur it is तनकर *tankar*.
- (4) The *comb* of reeds or bamboo in this bar, which keeps the threads of the warp apart, is called राख *rakh*.
- (5) The *heddles*, which alternately raise or depress the threads of the warp, are बाए *bae* or बै *bai*.
- (6) The set of three *reeds* which is placed in front of the heddles to keep the two sets of the threads of the warp apart is

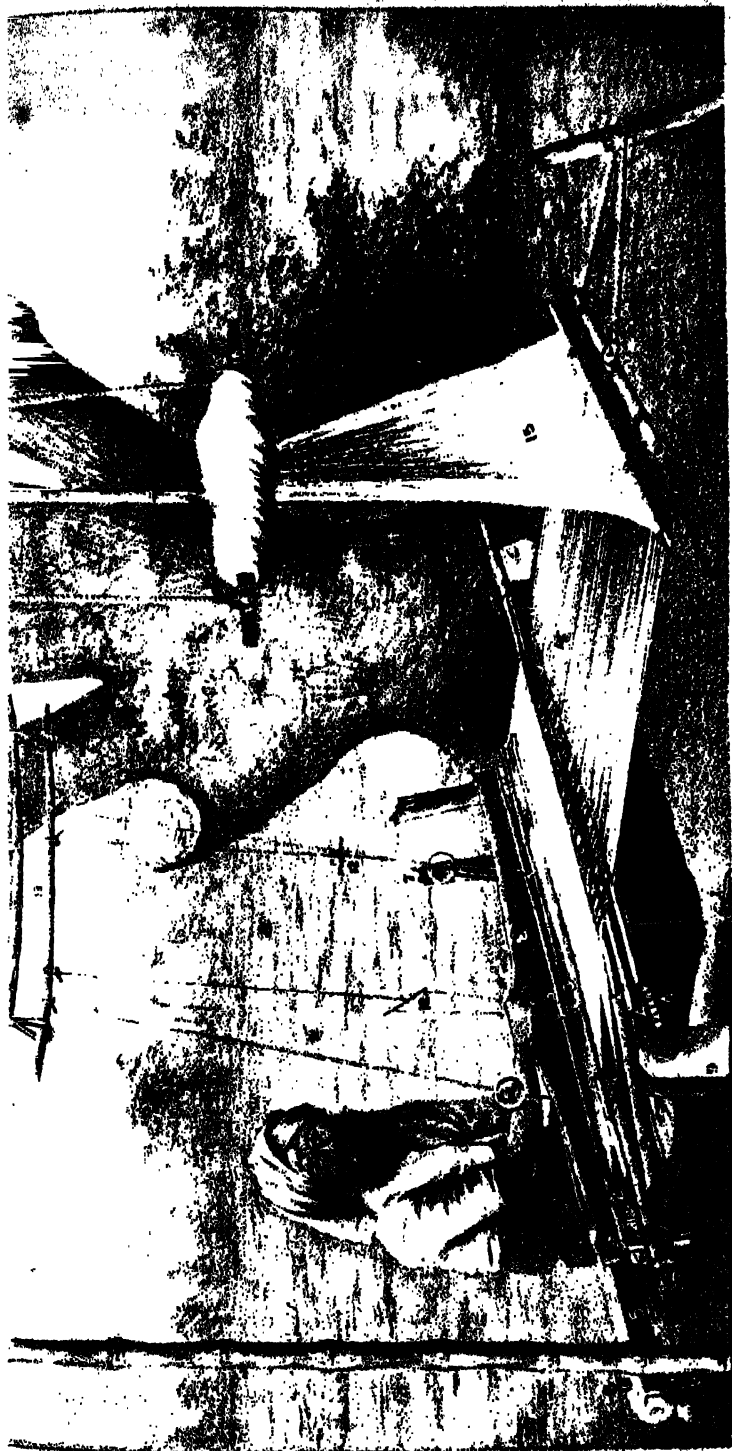

The Country Loom (Kariyah).

1. Hatka.
2. Rikkh (comb).
3. Ras (headlee).
4. Ser.

5. Chauspat (roller).
6. Jibhala.
7. Bamodari.
8. Markhat.

9. Kaniti.
10. Agela.
11. Jorbandha.
- 12, 13. Nachni (beddle-leavers).

13. Kar (upper beam).
14. Pü (woof).
15. Sir-dre.
16. Tungui.

अत्रावन *atrāwan* north of the Ganges generally and in Shahabad, and तरावन *tarāwan* elsewhere south of the Ganges. Another set of three reeds also used is called भञ्जनी *bhanjni* in Champāran, North Tirhut, Gaya, and South Munger, and the two sets together are called in North-East Tirhut अत्रावन भञ्ज *atrāwan bhānj*. In Patna and the south-east the reeds are also called सर *sar*.

- (7) The elastic *bow* which keeps the woven cloth stretched in front of the weaver is पन्निक *pannik* south of the Ganges; north of the Ganges it is पन्निक *pannikh*, and also पन्नी *panni* in East Tirhut.
- (8) The wooden *roller* behind which the weaver sits, and on which the cloth is wound up as fast as it is made, is in the north-west, in West Shahabad, and in South Munger लपेटन *lapetan*; elsewhere it is चौपत *chaupat*.
- (9) This is supported by *posts* called खूँटा *khūnta*; also the right and left ones have different names, viz. the right-hand one, which passes through the roller and prevents it turning round, is जिभेला *jibhela* everywhere, in North-East Tirhut also जिहला *jihla*, and in South-East Tirhut also जिहेला *jihela*. In South Bhagalpur it is गाली खूँटा *gāli khūnta*. The left-hand one, against which the roller rests, is बँधेला *banghela* north of the Ganges everywhere. Also, in East Tirhut, as also to the west and Gaya, it is बँवारी *banwāri* or बँवरिया *banwariya*, in Shahabad it is also पछेला *pachhela*, and in South-West Tirhut कँधेला *kāndhela*. In South-East Tirhut it is also called बमैला *bamaila*. In South Bhagalpur it is simply खुँटा *khutta*.
- (10) The *wool* is supported at the end opposite the weaver by a piece of wood called खरकौट *kharkaut* to the west and खरकौटी *kharkauti* to the east or खरकूटी *kharkūti* in South Bhagalpur, which is held up by pillars called कनेली *kanaili* to the north and west, खूँटा *khūnta* in East Tirhut, थूम *thūm* in Patna, थुम्भी *thumbhi* in Gaya, and थुम्भा *thumbha* in the east, and also खरकौ खूँटा *kharko khūnta* in South Bhagalpur.

- (11) The woof is held tight by a string, which is fastened to its end and passes round a peg at the extreme end of the loom and back again up to the weaver, where it is fastened within his reach to another peg. He is thus able to slacken the woof as necessary. The first peg is called अगेला के खूंटा *agela ke khūnta*, or in Tirhut सरकौनी के खूंटी *sarkauni ke khūnti*; the second peg is called डोरबन्धा के खूंटा *dorbandha ke khūnta*, or in South Bhagalpur कनकिली *kankilli*.
- (12) The *treadle*, which the weaver moves with his foot, is पौसर *paunsār* or पौसर *pausār* generally, and in East Tirhut पसर *pasār*. The knob on this, held between the weaver's toes, is पौसान *pautān*.
- (13) The *upper levers*, to which the heddles are attached, are नचनी *nachni* generally. In East Tirhut they are लोचनी *lochni*, and in South Munger लचनी *lachni*.
- (14) These levers are fastened to an *upper beam*, which has various names, viz. अबेर *abher* to the west, भितभेरा *bhitbhera* in Saran and Champāran, धचाना *dhachāna* in South-West Tirhut, धचान *dhachān* or अकासी *akāsi* in North-East Tirhut, उपरकर *uparkar* in South-East Tirhut, करबार *karbār* in Gaya, and कर *kar* in Patna and South Munger.

364. The loose end of the woof (पार *pāi*) is called सिरारा *sirāra*, and it is wound up on लङ्गनी *langni*, which is hung up out of the way.

CHAPTER VI.—THE SALTPETRE MANUFACTURER.

365. He is called नोयान *noyān*. The round vat in which he dissolves the saltpetre from the saline earth is कोठी *kothi* north of the Ganges, and south of it अहरी *ahri*. The mother liquid thus produced flows out through a drain called पनार *panār* in Tirhut and to the east, and पौनार *paunār* to the west; also in Saran मोहान *mohān*, and in South-West Shahabad परनौहा *parnauha*. It flows into an earthen vessel fixed in the ground, called नदहा *nadha*, नाद *nād*, or नादा *nāda*, also परचा *parcha* in Tirhut and towards the west, and गर्नी *garni* in South-East Tirhut.

366. The mother liquid is called रस *ras*, or in South-West Shahabad अग्रस *agras*. After the saltpetre has been deposited, the

fuse liquid from which salt can be educed is called पचाही *pachhāri*, in South-West Shahabad काही *kāhi*. In Saran काही *kāhi* means the liquor from which salt is educed, and पचाही *pachhāri* the refuse which thrown away.

367. Over the round vat are placed bamboo rafters, which are called कोरटे *koratē* to the west, कोरो *koro* in North-East Tirhut, and पतवतन *patwatan* in South-East Tirhut. These are supported on bricks, अंता *anta*, and over them is spread straw, called चाजा *chhāja*, चिह्नी *chitti*, or खर *khar*.

368. The mother liquor is boiled in a large iron pan called कराह *rah*, or (to the east) तौला *taula*. When made of earth it is called कुंडा *kunda*, or in Saran खोर *khōr*. The fireplace is called चूल्हा *chūlha*. The pot for cooling the boiled liquid is हँडिया *hanriya*, or to the east तौला *taula*.

369. The iron curved spud by which the saline earth is scraped from the ground or wall is खुरपा *khurpa*, and the mattock for digging is डारा *phahura* to the west, कोदार *kodār* in Tirhut, and कुदारी *kudāri* in Saran. The basket for carrying the saline earth is टोकरी *tokeri*, and that for carrying the saltpetre चैडी *chhainti*

370. In South-West Shahabad—

- (a) जरुवा खोरा *jarua sora* is saltpetre prepared by boiling ;
- (b) आबी खोरा *abi sora* is saltpetre prepared by evaporation by the sun's rays ; and
- (c) कलमी खोरा *kalmi sora* is refined saltpetre.

CHAPTER VII.—A DISTILLERY OF COUNTRY-LIQUOR.

371. भडोदार *bhatthidār* or अहकार *adhkar* is a distiller. In Saran he is also called रंकी *rānki*. कलाल *kalāl* is a Muhammadan who sells country-wine ; कलवार *kahōār* is a Hindu who does this. कलाल *kalāl* and रंकी *rānki* are caste names. When a man of another caste sells liquor, either on his own account or as a servant, he is called गद्दीवान *addiwān*. भडो *bhatthi* is a distillery. कलाली *kalālī* or गद्दी *gaddi* is a place where country-spirits are sold.

372. The still is called भडो *bhatthi*, and consists of the following parts:—

- (1) देग *deg* or जेग *deg*, the boiler.—This has a baked earthen cover called अहकार *adhkar*, or in Saran अहकार *adhkar*.

- (2) Over this is inverted a wide-mouthed globular copper vessel; this is called ताम्बी *tāmmi*, or in Saran तामिया *tamiya*. It serves as a condensing-vessel. The spirit rises into it, and over its outside surface runs continually a supply of cold water.
- (3) The water reservoir is नाद *nād*. The water flows from this through a pipe called पौनली *paunalli*, or in South Bhagalpur पन्नाली *pannāli*, and in Saran also डोंगा *dhonga*, on to the top of the condensing-vessel.
- (4) The spirit thus condensed flows out through a pipe called मधनारी *madhnari*.
- (5) The spirit is collected in an earthen jar called टांक *tānk* or मटुका *matuka*, and in this it is carried to the place of sale.
- (6) The refuse left in the boiler is रस *ras*; also, in Gaya, बकस *baksa*, and in South Bhagalpur also गौरा *gora*.
- (7) साजन *sājan* or चाबन *chhāban* is water used for diluting spirit, so as to increase the quantity for sale.
- (8) The liquid for distillation is made as follows. Liquid (रस *ras*) and sweet preparations (मीठा *mītha*) are mixed and buried in the ground. This mixture is called कसांजी *kasānji*. When it is ripe महूच *mahua* is poured into it. This act of mixing is called भरती *bharti*. When the mixture is sufficiently fermented for distillation it is called बोहार *bojhāi*. The constituents of the रस *ras* and of the मीठा *mītha* vary, and are not detailed here.
- (9) Earthen cups for drinking country-spirit are चुक्कर *chukkar*, गुक्की *gukki*, or पितावा *pitāua*.
- (10) Pots for keeping the spirit in the shop are called माट *māt*, कोरेना *koarena*, or in Shahabad कोरेना *kaurena* and बर्याम *buiyām*. In Saran another name is करारा *karāra*.

373. Ordinary weak country-spirit is दोकानी *dokāni*, and also in Saran खसिया *khasiya*; the next strongest (when made of गूर *gūr* only) is कन्दी *kandī* or (when made of other materials) दोबारा *dobāra*; the next strongest is सौंघी *saumphī*, or in South-East Tirhut सेबारा *sebāra*; and the strongest of all, महारदार *mahardār*.

SUBDIVISION VIII.

APPLIANCES USED BY MISCELLANEOUS VILLAGE
TRADERS AND PROFESSIONALS.

CHAPTER I.—THE PALM-JUICE SELLER.

374. The palm-juice seller is पासी *pāsi*.

375. In climbing up the palm-tree he uses a heel-rope, which ties his feet close together. At the same time he has a stout rope passing round the tree, and his body. He leans back against this rope, and presses the soles of his feet, thus tied together, against the tree. He then climbs up the tree by a series of hitches or jerks of his back and his feet alternately. The heel-rope is called मकरी *makri*, or to the west पकुसी *pakusi*. In Shahabad it is पकसी *paksi*, and in Tirhut and Patna पंदिवा *phandiya*. The body-rope is generally दंडुवाँस *danrwāns*. To the east it is also रसा *rassa*, and in South Munger बरन्ना *bārta*.

376. The longish earthen pot in which the juice is collected is called लबनी *labni*, or to the east उरुह *urharh*. Round its neck is tied a string, called to the west अरुवन *arwan* and to the east फनी *phanni* or फन्की *phanki*, or in South-East Tirhut रौना *rauna*. This string is hooked on to a hook, अंकुरा *ankura*, or in Saran अंकुरा *ankurha*, in Shahabad अंकुसी *ankusi*, and in South Bhagalpur अंकोरा *ankora*, which is tied to the man's waist by a rope, लुहार *lewār*, or in Saran अरुवक *arkas*, in Champaran दंडा *dānra*, and in South Bhagalpur पेटार *petār*.

377. The sickle used for cutting the palm-tree is हंसुली *hansuli* to the west and हंसुवा *hansua* to the east. It is sharpened on a piece of wood called लौठा *lautha*, and also, to the east सोडा *sonta*, or पसुवठ *pasuath* in South Bhagalpur, and बलेठा *balēthā* in South Munger.

378. A हथौना *hathauna* or तरकही *tarhātti*, or in Saran लबना *labna*, is a large longish earthen pot for holding toddy (ताड़ी *tāri*). In South Bhagalpur तौला *taula* or कुंडा *kunda* is an ordinary vessel for holding toddy. नापा *nāpa*, or in Saran नपही *naphi*, is a small earthen pot used for measuring it, and जोरवा *zorwa*, बररिया *barariya*, and गोलुवाँ *golwān* are in South Bhagalpur earthen vessels in which toddy is sold.

379. A toddy palm-tree is तार or ताड़ *tār*, and the juice is तारी *tāri*. There are two kinds of this tree—the female one, which bears fruit and is called फलतार *phaltār*, or in South Bhagalpur फाला *phalla*, and the male one, which produces hairy flowers and is

called बल्लनार *baltār* or झुल्लनार *phulltār*, or in North-East Tirhut झुल्लनारी *phuldo*, and in Saran बहिरा *baliha*. A खंगरा *khangra*, खंगरा *khagra*, or खंगरी *khagri* is a young palm-tree. A कोही *koḥi* (North-East Tirhut) or a बहिरा *bahira* (South-East Tirhut), बंजी सिखवा *bānji siswa* or अनाथु *anāthu* (South-West Tirhut), is a palm-tree which does not produce juice; a बसन्ती *basanti* is a tree which produces juice in spring, and जेथुवा *jethua*, or in Saran साब *sāb*, one which does so in summer, while गौर *ghaud* is one which does so all the year round. In the east गौर *ghaur* is a tree which produces juice in the rainy season.

380. To cut a palm-tree for the juice is चेष चह्वेव *chhewab*.

CHAPTER II.—THE BIRD-CATCHER.

381. The bird-catcher or मिरसिकार *mirsikār*, or in Shahabad बहेलिया *baheliya*, uses a number of नल *nal* or नर *nar*, which are long shafts of bamboo tied together like a fishing rod, of which the top one is called कम्पा *kampa*, or in South Bhagalpur खोंचा *khoncha*. On this last is applied bird-lime (लासा *lāsa*), and the bird-catcher cautiously approaches the bird, concealing himself behind a टट्टी *tatti* or screen of leaves and branches. When the bird is within distance it is struck with the limed कम्पा *kampa*, and thus caught. The चोंगा *chonga* is the bamboo tube for keeping the bird-lime.

382. The फाँद *phānd* or फाँदा *phānda* and चोगोड़ा *chaugora* are two kinds of nooses. बटियारी *batiyari* is a net used in the day-time, and चानर *chātar*, one used at night for catching birds.

CHAPTER III.—THE BARBER.

383. The barber is चंजाम *hajām*, ठाकुर *thākur*, नाई *nāi*, नाच *nāu*, or नौचा *nauca*. In North East Tirhut he is also नहेरि *naheri*, and in Saran sometimes ओस्ता *osta*. He has his लोखर *lokhar* or किरमत्त *kismat*, किरमत्त *kisbat*, or किरमत्त *kisbat*, which is his instrument-bag. Also he has a चामौटा *chamauta* or चमौटी *chamauti*, or piece of thick leather used as a strop, a मोचना *mochna* or tweezers, and a छुरा *chhūra* or चरुरा *astūra*, or to the east छुर *khūr*, or razor. His nail-parers are नहरनी *naharni*, but in Champāran they are नहरन *nahrān*, and लहरनी *laharni* in East

Tirhut. His whetstone is *सिला silla* or *सिल्ली silli*. *कैंची kainchi* is his scissors, *कटोरी katori* his brass cup for water, *दर्पण darpan* his looking-glass, and *लुंगी lungi* the cloth which he spreads in front of the person he is shaving, and on which the hairs fall.

CHAPTER IV.—THE COUNTRY SURGEON.

384. The country surgeon is *जर्राह jarrāh*, *जराह jarāh*, or *हजाम hajām*.

385. Among his instruments are *जमूरा jamūra*, a tooth-extractor, *चोभा chobha* or *नखार nastar*, a lancet for the arm, and *थुनका thunka*, a lancet for the head.

386. For circumcision (*सुन्नत sunnat* or *खतना khatna*) he has *जन्नी jantri*, *घोड़ी ghori*, or in South Bhagalpur *चूँटा chūntā*, which are nippers of bamboo, and *सलार salāi*, which is a bamboo needle for holding up the foreskin.

CHAPTER V.—THE FARRIER.

387. The farrier or *नालबन्द nālband* has the following appliances.

388. A *मेखारी mekhāri* or *किसबत kisbat*, which is the bag in which his tools are carried, a *छुरी chhūri* or curved knife, a *सुमतरास sumtarās* or large curved knife, a *जम्बूर jambūr* or pincers, a *रेत ret* or file, a *बलखा balkha* or *मार्तौल mārtaul* or small but long hammer, a *दोषाली doāli*, or in South Bhagalpur *बलखा balkha*, which is a leather for holding up the horse's hoof, a *पुजमाल pujmāl* or hair string for tying the ear of a refractory horse, a *हलखा halkha* or iron ring, and a *सुमकट्टी sumkatti* or chisel for cutting the horse's hoof.

CHAPTER VI.—THE WASHERMAN.

389. The *धोबी dhobi* or washerman uses a *पटाथा patha* or *pat*, which is the washing-board, of which the support is in Shahabad *थेहुआ thehua* or *नेवनाथ newnath*. In South-West Tirhut it is

called चौकी *chauki*, and, when made of stone, पथर *pathal*. His iron is रसगिरी *istiri* or (in North-East Tirhut) मिस्तिरी *mistiri*. His ironing cloth is बथन *bethan*, and his starch कलप *kalap* or कलफ *kalaph*.

390. When the article to be washed is too heavy for him to lift up and dash upon the washing-board, he beats it with a mallet, called मुंगरा *mungra* or मुंगरी *mungri*, or (in Saran) दंसन *dānsan*, (in North-East Tirhut) सोंटा *sonta*, and in South-East Tirhut लाठी *lāthi*. In South-West Shahabad it is called कठका *kathka*, and in South Bhagalpur धोबदंग *dhobdāng*. The clothes-line or drying-frame is तनाव *tānav*. His bundle of clothes is बकुचा *bakucha*.

391. The act of beating the clothes is कुन्दी *kundi*, and to beat the clothes is पीटन *pitab*, or धोएल *dhoël* north of the Ganges, बिहारब *bichharab* (in Patna), निहारब *nichharab* (in Gaya), निहारल *nikhharal* (in Shahabad), खोच *khinchab* (in South Bhagalpur), and चॉंटन *chhāntab* or चॉचन *phinchab* (in South Munger and Shahabad).

392. South of the Ganges clothes which are well washed are निमाड़ *nimār*, or in South Bhagalpur गोबर जार *gobar jhār*. In Champāran they are निहार *nikhār*. The half-washing given to new clothes is कम्बो *khamso*, or in South Bhagalpur खाम्बो *khāmso*. In Gaya the washing of a cloth after it has had patterns printed on it is बिहारनी *bichharni*.

393. The honesty of the washerman and his tenderness for the clothes committed to his care are not considered of much account in Bihār, and there are numerous proverbs coined at his expense, e.g. धोबी पर धोबी बसे, तब कपड़ा पर साबुन पड़े *dhobi par dhobi base, tab kapra par sābun pare*,—no soap ever touches clothes unless many washermen live together (when owing to competition they wash well). Again, धोबिक कपड़ा केर किछु नहीं फाड *dhobik kapra ker kichhu nahī phāt*,—nothing belonging to a washerman's father is ever torn by him (i.e. those are the only clothes about which he is careful). It is also a wise precaution, which according to Bihār ideas should universally be adopted, to disbelieve a washerman when he says the clothes are 'nearly' ready. A washerman's donkey is a bye-word, as in the proverb गध्या के नो दोसर गोसैन्या, धोबिया के नो दोसर परोहन, *gadha ken na dosar gosainyān, dhobiya ken na dosar parohan*,—an ass has only one master (a washerman), and the washerman has only one steed (a donkey). Again धोबी नाच दरगजी, ई मोजू बसगरजी *dhobi, nāū, darji, i timu algarji*,—there are three careless people, the washerman, the barber, and the tailor.

SUBDIVISION IX.

TOOLS AND APPLIANCES USED BY COUNTRY ARTIZANS.

CHAPTER I.—THE CARPENTER AND TURNER.

394. The carpenter is बड़न्ही *barhi*, or, in East Bihār optionally कमर *kamār*. In South Bhagalpur he is also called मड़ेया *maraiya*. His workshop is कमरग्यावर *kamarsāyar* or बड़न्ही खाना *barhi khāna*. A proverb about him is ई बरिबक गाम कनेताइ जमिका रवान नठ बरुहा *i buribak gām kamaitāh, janika rukhān na basula*,—this fool (of a carpenter) would serve the village when he has neither chisel nor adze; said of one who undertakes to do a thing without possessing the means. He uses the following tools :—

395. The adze.—बसुला *basūla* or, especially in South and West Bihār and South Bhagalpur, बरुहा *basula*. In South Munger it is बसिला *basila*. A similar tool is टङ्गा *tānga*, टाँगा *tānga*, टाँगी *tāngi*, or टंगारी *tāngāri*. In North and East Bihār it is also called कुहारी *kulhāri*. This is a larger adze, and is used chiefly by sawyers (बरकसिया *arkasiya* or चाराकस *ārākas*) in squaring logs, and by carpenters for rough work or for cutting down trees.

396. The large saw.—चारा *āra*, and south of the Ganges also चररा *arra*. The small saw.—चारी *āri*.

397. The large hammer.—थौरा *hathaura*, or in South Bhagalpur लिहावर *lihāvar*. The small hammer.—थौरी *hathauri*, मारगौल *mārtaul*, and in West Tirhut and south of the Ganges also घन *ghan*. In South Bhagalpur it is called मरिया *maria*.

398. The barma or बरमन *barman* is a revolving awl or drill, worked with a bow and string, and used as a gimlet or centre-bit. The bow used with it is कमानी *kamāni*, or in South-West Shahabad कामानक *kamānak*. The handle round which the string goes is गुल्फी *gulphi* or गुली *gullī*. In South and East Tirhut the word is कुल्फी *kulphi*. In Gaya it is मूठ *mūth*. The cap at the top, on which the palm of the hand rests to press the awl, is टोपी *topi*, पैला *paila*, दबनी *dabni*, or दबौडा *dabauta*. The awl itself is बरमा *barma* or बरमन *barman*. The string is north of the Ganges दोलाही *doḷāhi*, and south of it डोरी *dori* or जोती *joti*, or in South-West Shahabad जैवर *jemwar*.

399. The following are various kinds of *chisels* :—

- (a) The कचक *kachchak* north of the Ganges, and the बतारी *batāri* or बतारी *batāli* south of the Ganges, is broad at the base and narrow at the point. In South Bhagalpur it is called कज्जक *kajjak*.
- (b) The रम्बा *ramba* is a long chisel for making mortice holes.
- (c) The चौरसा *chaurasa* is broad and straight; another name in Gaya and Shahabad is बतारी *batāsi*.
- (d) The रुखान *rukhān* or रुखानी *rukhāni* is like the *kachchak*, but is larger and thicker, and is used for coarse work. It is also a generic term for all chisels.
- (e) A small chisel with a rounded edge for making lines on wood is north of the Ganges गोलक बुरज चाप *golak buruj khāb*. South of the Ganges and in Saran it is गिरन्दा *girda* or गोरन्दार रम्बा *gordār randa*. In South Bhagalpur it is also खोलिया *kholiya*.

400. *Gouges* are गोलक *golak*, गोलक *golakh* (Gaya), गोला रुखानी *gola rukhāni*, or गोरन्दार रुखानी *gordār rukhāni*; other names are गौच *gauch* (South-West Tirhut) and गिरमित *girmit* (? gimlet), North-West Tirhut. A large gouge for heavy work, such as hollowing out rice-mortars, is बँक रुखानी *bānk rukhāni*. A square gouge is कचक रुखानी *kachchak rukhāni*.

401. The common *plane* is रम्बा *randa*, of which the blade is पल्ली *phalli*, or in Shahabad फलसा *phalsa*, and the body कुन्दा *kunda*. The wedge for holding the blade has various names, viz. north of the Ganges खूँटी *khānti*, ठेकी *theki*, or चेखी *chaili*. South of the Ganges it is in Shahabad खूँटी *khunti* or ठेपी *thepi*, and to the east पच्छी *pachchi*, पचरी *pachri*, or पचर *pachchar*. When the blade has a coarse edge for rough work, it is झरना रम्बा *jharna randa*; also दान्त रम्बा *dānt randa* in South-West Shahabad. A plane with a fine blade is सापी रम्बा *sāphi randa*. The दराज *daraj* is a narrow plane for squaring the edges of boards.

402. *Grooving-planes*.—There are—

- (a) The plane for cutting square grooves.—बुरज चाप *buruj khāb*, or (South of the Ganges) बुरज (or बुरज) चाप *buruj* (or *guruj*) *khāp*.
- (b) The गलता *galta* is for cutting round grooves. In West Bihār and South Munger it is also called किरची *kirchi* or किल्ली *khilli*.



TURNER (KHARÁDD) AT WORK.

Photographed by the author in 1907. Published in the "Journal of the Royal Asiatic Society" (London), 1908, p. 100.

- (c) The कारी के रन्दा *jhāri ke randa* or (north of the Ganges) पलान *palāun* is a plane for making grooves for panelling.

403. The following are files :—

- (a) रैती *reti* is the common file.
- (b) The file for sharpening saws is generally कतारा *katra*. Local names are कतरि *katari* in North-West Tirhut, कतरोही *katrohi* in East Tirhut, तेषल *tephal* in Gaya and Shahabad, तेषला *tephalla* in Sāran, and कनासी *kanāsi* in West Shahabad.
- (c) सोहन *sohan*, or in East Tirhut सोहेन *sohen*, is a coarse rasp.
- (d) The चौरसा *chorsa*, or to the west चौरसा *chaurasa*, is a broad file.
- (e) The निमगीरिद *nimgirid* is a half-round polishing file. In South Bhagalpur it is मैगिरी *maigiri*.
- (f) The चौरस रैति *chauras reti*, or in South Bhagalpur चौपचल रैती *chaupahal reti*, is a square file.

404. The square, or gnomon, is बडाम *batām*, गुनियॉ *guniyān*, or चलन्ता बडाम *chalta batām*. The compasses are परन्काळ *parkāl*. A blunt point for drawing lines is खतकच *khatkas*, or in South Bhagalpur कोरन्सुत *korsūt*. Sand-paper is सरेस कना *sares kannā*, सरेस कागज *sares kāgaj*, or सरेस पत्ता *sares pattā*. In South Bhagalpur it is साफी *sāphi*. The pincers for drawing nails are जखूरा *jamhūra*, जमूरा *jamūra*, or सँडुसी *saurṣi*. Glue is सरेस *sares*. पथल *patthal*, पथल *pathal*, or सिल *sil*, is the grindstone. The block on which the man works is ठीचा *thīha*, ठेचा *theha*, or in South Bhagalpur ठिया *thiya*, ठिहा *thiha*, or परन्कडो *parkattho*. In Gaya and Champāran it is called परिचाडा *pariyātha*.

405. The English *auger* is also used, and is called खगगर *augar*, or in Tirhut गिरमिट *girmit* (P = gimlet).

406. A *lathe* is खराद *kharād*, and the man who works it is खरादी *kharādi*, a turner.

CHAPTER II.—THE BLACKSMITH.

407. The blacksmith is लोहार *lohār* generally, and in South-East Tirhut he is also ठाकुर *thakur* or कामार *kamār*. His smithy is कामरसायर *kamarsāyar*. In Sāran it is also लोहसारी *lohsāri*, and in South Bhagalpur it is कामरसारी *kamarsāri* or मरारी *marāri*.

408. His *anvil* is निहार *nihai* or नेहार *nehai*; but in South-East Tirhut it is लेहार *lehai*, and in South Bhagalpur लिहार *lihai*. This is fixed in a block called ठेहा *theha* north of the Ganges, ठीहा *thiha* in Shahabad, and in South Bhagalpur ठिया *thiya*, परगठ *parkath*, or गरियास *gariyas*. In Patna and South Munger it is परेठा *paretha* or परगठ *parhattha*, and in Gaya परिवठा *pariyatha*. In South-West Shahabad it is अंकुठ *ankuth*. A well-known proverb about an anvil is छत्र चीठ नेहारक नाँवा *sunn chot nehāik māntha*,—if the anvil has nothing on it, the blow falls on its head.

409. The *ghanmudhi* is the *swage block* or *perforated anvil* on which iron is placed when being pierced with holes, and बीरी *biri* or बीर *bir* (east generally, Patna, and Gaya) or हाना *hanna* (South Bhagalpur) is the round block of iron placed on this, also pierced with a hole. This latter is also used for making heads of nails, and another name for it is चपनरावन *chaprāwan*, चपनौना *chaprāuna*, or चपनौनी *chaprāuni*.

410. The large *hammer* for welding is गन *ghan*; smaller than this is the हथौर *hathaur* or हथौरा *hathaura*; and smaller still the हथौरी *hathauri* or मरिया *mariya*.

411. The *जम्हूरा* *jamhūra* or जमूरा *jamūra* is a pair of *pincers* or *tongs* round at the tips; other names are गडवा *gahua* (Champaran, West Tirhut, and Patna), सँकुरी *sanrsi* (Shahabad and South Bhagalpur), and बँगुरी *banguri* (South-West Shahabad). Everywhere सँकुरी *sanrsi* is used for a pincer adapted for taking a hot piece of iron out of the fire, tightening nuts, &c. To the west the सुगही *sugahi* is a pair of horn or wooden pincers.

412. The iron *poker* for stirring the fire is north of the Ganges अंकुरा *ankurha*; in Gaya and Shahabad it is अंकुरा *ankura* or अंकुरी *ankuri*; and in South Bhagalpur अँकोरा *ankora* or अँकुरा *ankra*. North of the Ganges, to the west, it is also कुल्लार *kultāra*; while in Patna, Gaya, and South Munger it is कोल्लार *kollāra*.

413. The *cold chisel* is छेनी *chheni*, and the chisel for making holes in iron is टोपन *topan*, with a variant टोपना *topna* in Patna and Gaya; another name is सुम्हा *sumbha* south of the Ganges or सुम्मा *summa* or सुम्मी *summi* north of the Ganges.

414. The fixed *bellows* is भाथी *bhathi*, and also (south of the Ganges) भाँथी *bhanthi*. The hand-bellows is दुबन्थी *dubanthi* when worked with both hands, एकदन्थी *ekhanthi* when worked with one hand, and दुपोथा

supāua in South-West Shahabad. In the south-east it is also कठ भाँधी *kath bhānthī*. The end of the bellows pipe which goes into the fire is मूरा *mūra*, मुरी *mūri*, or मुड़िया *muriya*. In Saran it is अँकुरा *ankurha*; in South Bhagalpur, मुरी *mūri* or साखल *sālak*; in Patna, मोहका *mohkha*; and in South Munger, मोहकी *mohkri*. The pipe itself is फूँक *phūnk*; also north of the Ganges and to the west हूँकी *chhūnchhi* or हुँकी *chhuchchhi*; and in Patna, Gaya, Saran, and East Tirhut चोंगा *chonga*, or in South Tirhut चोंगी *chongi*. The clay pipe over this is आरन *āran* or आरनी *arni*, or in South-East Tirhut आर *ār*. In East Tirhut it is also मदिहम *matiham*, and in South-East Tirhut मेटुम *metum*. The wooden sides of the bellows are तखता *takhta*; also in Patna, Gaya, and South-West Shahabad पटरा *patra*. The leather sides are चमका *chamra*; also चाम *chām* (optionally south of the Ganges) and चाख *khāl* in Champaran, Patna, and Gaya. The valve is पका *pankha* or पकी *pankhi*; also (in Patna) पककी *pankhri*. In South-East Tirhut and Champaran it is गद्दी *gaddi*. The pivot on which the pair of bellows works is कोड़ा *konrha* north of the Ganges; also in North-West Tirhut सुरसग *sursa*. South of the Ganges, to the west, it is धूरी *dhūri*, and अँकुरा *ankura* to the east and also in Shahabad and Champaran. The pillars which support it are खम्भा *khambha* north of the Ganges and खूँटा *khūnta* south of the Ganges and in South-East Tirhut. The upper iron bar is बरेठा *barenra* or बरेठी *barenri* north of the Ganges, and बरेठा *baretha* in Patna and Gaya. In Shahabad it is बेड़िया *benriya*, in South Bhagalpur दन्दा *danda*, and in South-East Tirhut दन्दा *danta*. The lever which works the bellows is छीप *chhip* in the North Gangetic tract, and also दन्दा *danta* in Tirhut; south of the Ganges it is लाठ *lāth* or लाठा *lātha*, and in South-West Shahabad दन्दा *danda*. In South-West Shahabad a small bellows worked by both hands is मेँररुआ भाँधी *menrarua bhānthī*. A well-known saying about the bellows is तुलसी चाख गरीब के हरि सेँ सवाल न जाय, मुसला चाम का फूँक सेँ होय भवस जो जाय *tulasi āh garīb ke hari señ sahal na jāy, muala chām kā phūnk señ loh bhasam ho jāy*,—O Tulsi! God cannot withstand the sigh of a poor man: the blowing of dead leather (in a bellows) reduces iron to ashes.

415. The बरना *barma* is a revolving awl or drill worked with a bow, कमानी *kamāni*, with a leather string, तसमा *tasma*. Sometimes a string is used instead of a bow, and this is called दोबाही *doahī* or जोती *joti*, or in South-West Shahabad जँवर *jemwar*. The iron spike of the awl is north of the Ganges दन्दी *dandī* to the west and पल्ली *phalli* to the east. South of the Ganges we have दँस *dāns* in Shahabad, दन्दी *danti* in Patna and Gaya, and दन्दी *dandī* again in the south-east.

416. The fixed vice is बाँक *bānk* or (in South Bhagalpur and South Munger) बैस *bais* (?=vice), and the hand-vice is हथकल *hath-kal* or (in Patna and Gaya) हाँकल *hānthkal*. The two sides of the vice which grasp the iron are पला *palla*; the screw is मुसरा *musra*, or in North-West Tirhut कबला *kabla*; and the socket for the screw to work in is हुकी *chhuchchhi*, except in Shahabad, where it is चोंगिया *chongiya*, and South Bhagalpur and Champāran, where it is चोंगा *chonga*. The handle for turning the screw is north of the Ganges मुसरा *musra* or चलीनी *chalauni*. The latter name is also current in Shahabad, where in the south-west of the district we also have हथकरा *hathkara* or दंदा *danda*. In South Bhagalpur it is हातुल *hātul* or हत्ता *hattha*, and elsewhere it is हथरा *hathra*. The spring is कामनी *kamāni*.

417. The tap and die for making screws is north of the Ganges बाँदिया *bādiya* or बदीया *badiya*; the latter is the usual form in North-East Tirhut. South of the Ganges, in Gaya and Shahabad, it is बहिया *badiya*, and elsewhere बधिया *badhiya*. In South Bhagalpur it is also called दार *dāi* (die). Of this the female screw is कुटका *kutka*, the tightening screw चुटकी *chutki*, and the nut-maker पेचकस *pechkas*. डिबरी *dhibri*, or in Sāran कबला *kabla*, is the nut of a screw.

418. The common files are रेतौ *reti*, and the round files गोलक *golak* or गोलक *golakh*, and in South Bhagalpur गोल रेतौ *gol reti*. The half-round file is निमगीरिद *nimgirid*, and the triangular file in Sāran तिनपहा *tinphalla*, in Champāran तिरपहा *tirphal*, in Shahabad तिरपहा *tirpahal*, in Tirhut तेषहा *tephal*, in Gaya तेषहा *tepahal*, and elsewhere तिनपहा *tinpahal* or तिरपहा *tirpahla*.

419. The compasses are परकास *parkāl* or कपास *kampās*. The mould is साँचा *sāncha*, and the vessel for cooling hot iron पनिहारा *panihāra* in Champāran, West Tirhut, and Gaya; पनिहंदा *panihanda* or पनहंदा *panhanda* in Shahabad and South-East Tirhut; चाहा *chāha* (also in South Munger), लबेरी *laberi*, लाबर *lābar*, or लबेर *laber* also in South-East Tirhut; नबेर *naber* or नमेर *namer* in North-East Tirhut; and नबेरी *naberi* in Tirhut generally. In South Bhagalpur it is पनचाहा *panchāha*.

CHAPTER III.—THE MASON OR BRICKLAYER.

420. The mason is called राज *rāj*, also राज मिस्तिरी *rāj mistiri* north of the Ganges, and राज मजूर *rāj majūr* in South Bhagalpur and South Munger. In Sāran and Champāran he is also थार *thawat*.

421. He uses the बसुली *basuli*, which is a pointed hammer for cutting bricks. In Shahabad लोह *lorh* is an iron hammer for breaking stones

422. His *trowels* are (1) करनी *karni*, the largest, for mixing mortar; (2) मणहोला *manhola* or (in South-West Shahabad) चबन्दा *adhla*, a smaller one; and चबन्दा *nahla*, or in Tirhut and the west कलम *kalam* or कलमी *kalmi*, the smallest one, for polishing the surface of the mortar.

423. *Mortar* is मसाला *masāla* or (in North-East Tirhut) गच *gach*. when made of brickdust and lime; when made of mud it is गिहावा *gilāwa*, also गरी *garra* (Patna, Champāran, and North-East Tirhut), गारा *gāra* (Saran and the east), कादो *kādo* (South-West Tirhut), and डेर *lei* (South-West Shahabad).

424. The wooden *beater* for consolidating and smoothing plaster is मुंगरी *mungri* or थापी *thāpi*. The रोल *rol* or रौल *raul* (South Munger, Patna, Saran, and Tirhut) is a long stick for smoothing the plaster. Other names are पचन्दा *pahta* or पाटा *pāta*, पैटा *paita*, पैन्दा *paihta* (South Munger), and फरमा *pharma* in Gaya. In Shahabad and South Bhagalpur चिरना *chirna* is a slip of wood used for the same purpose. The *scoop* for making moulding is north of the Ganges and to the east generally गोलाकच *golākas*, and also to the east गोला *gola*. Elsewhere south of the Ganges and in Champāran it is खुरचुनी *khurchuni*.

425. The *plumb* is साइल *sāhul*. The string is सूत *sūt*, and in Champāran and South-East Tirhut also डोरी *dori*; and the small pieces of wood fixed on the string are केंडा *kenra* or कैडा *kainra* in Tirhut, Shahabad, Patna, and Gaya, पत्ती *pattī* in Sāran and Champāran, फिटकिरी *phitkiri* also in Champāran, East Tirhut, and South Munger, फिरकी *phirki* in South-West Shahabad, and फेटकिना *phetkina* in South Bhagalpur.

426. The *square* is गोनिया *goniya*, गुनिया *guniya*, or गुनिचा *guniyān* to the west, also साधनी *sādhni* in Patna, Gaya, and north of the Ganges generally, and रबिल *rabbil* in South-East Tirhut and North Bhagalpur. To the west and in Gaya it is also बटाम *batām*.

427. The *maul-stick* is मिस्तर *mistar* in Patna, the North-West, and South Tirhut. In Tirhut, Gaya, and the west it is मिस्तर *mistar*. In South Bhagalpur it is चीप *chīp*.

428. The whitewashing *brush* is कुंची *kunchi*; in South Muager it is also जरनी *jharni*.

429. The *ladder* is सीढ़ी *sīṛhī*, and the *scaffolding* माँच *mānch* or मचान *machān* to the north of the Ganges. South of the Ganges the latter is पाठ *pāth* generally, or पाठ *pāth* in Shahabad. In Champāran, Patna, and Gaya it is also चाही *chālī*.

430. The नगर or नगाड़ *tagār* (also नगाड़ी *tagāri* in Tirhut) is the pot in which the mortar is mixed. The mortar-pot is नाद *nād* or नाँद *nānd*. The mortar-trough when made of clay is चाँड़ी *hānri*, also कोहा *koha* in East Tirhut, and optionally अचर्रा *athra* south of the Ganges. In South Bhagalpur it is also कहार *karhāi*. When made of wood it is कठरा *kathra* or कठौती *kathauti*.

431. The bricks are ground into powder (सुरखी *surkhi*) by a crusher, डँकी *dhenki* or (in Champāran) लाठ *lāth*. Of this the pestle is मूसर *mūsar* or मुसरा *musra*, or (in South-East Tirhut) सम्राठ *samāth*. The piece of wood on which the bricks are sometimes crushed is ओखरी *okhri* north of the Ganges; south of the Ganges it is ओखला *okhla* in Gaya, उखली *ukhli* in South Munger, भुरियाँ *bhuriyān* in Patna, and कँडिया *kanriya* elsewhere. It is supported by pillars, which are खूँटा *khūnta* or खुटा *khutta* in East Tirhut and south of the Ganges. In the latter tract they are also called खम्बा *khambha*. In West Tirhut and Sāran and Champāran they are जङ्घा *jangha* or खामा *khāma*. The axle on which it works is called अखाता *akhauta* in Patna and Sāran, उखाता *ukhauta* in Gaya, and also अखैला *akhaila* in Patna. In Champāran and North-West Tirhut it is मँजा *mānjha*, in South-West Tirhut किला *killa*, and in East Tirhut दन्टा *danta*. Sometimes a hammer is used for breaking the bricks, which is called मुंगरा *mungra* or (in Shahabad) हाथकुटा *hathkutta*, and in Sāran थापी *thāpi*.

432. The large earthen pot for water is घैला *ghaila*, also ठिलिया *thiliya* in Gaya and गगरी *gagri* north of the Ganges. The smaller pot is हाँड़ी *hānri* or हँडिया *hanriya*, also कोहा *khoha* in East Tirhut. South of the Ganges the pot with a spout for pouring water on the plaster is बधना *badhna*. In South Tirhut it is बधन *badhan*, and in South Bhagalpur जहारी *jhāri*. North of the Ganges generally करवा *karwa* or कँडिया *kantiya* is used, and in East Tirhut also फुचकी *phuchki*.

CHAPTER IV.—THE GRAIN-PARCHER.

433. The grain-parcher is कानू *kānu* or काँदू *kāndu*, with a variant काँदून *kāndūn* in Champāran, Patna, and Gaya. In Champāran (optionally) and in South-West Shahabad he is called गोंर *gonr*, and north of the Ganges and to the south-east he is also known as भरभुँजा *bharbhūnja*. Parched grain is भुँजा *bhūnja*, or in Shahabad भुँजना *bhunjna*. When it bursts in the parching it is called लावा *lāwa* or फुटवा *phutha*.



IN THE EAST AND WESTERN MACHINES (DHENKI).



434. His parching-house is **घोन्सार** *ghonsār* or **घोन्सारी** *ghonsār* to the west, and also to the west of the North Gangetic tract, **भन्सारी** *bhansārī*. In South-West Shahabad it is **भरन्साँय** *bharsāin*. The name **कन्सार** *kansār* or **कनिसार** *kanisār* is current in East Tirhut and to the east of the South Gangetic tract, including Patna and Gaya. In Tirhut it is also **कन्सारी** *kansāri*.

435. The *fireplace* is **चूल्हा** *chūlha* in Tirhut and to the east of the South Gangetic tract, including Patna and Gaya; also **भार** *bhār* generally, and **भन्सार** *bhansār* north of the Ganges and in Gaya, and **घोन्सार** *ghonsār* in Sāran. In South-West Shahabad it is **भरन्साँय** *bharsāin*.

436. The place in front of the stove, on which the grain falls, is **परुई** *parūi* in Shahabad and **परुआ** *parūā* in South Munger. In Patna and South-East Tirhut it is **पौर** *paur*; in Gaya, South Bhagalpur, and North-West Tirhut **पौरी** *paurī*; and in Sāran and Champāran **पारी** *pāri*. Another name more or less current north of the Ganges is **चौतरा** *chautra*.

437. The earthen pot in which the grain is parched is **खापड़** *khāpar* or **खपड़ा** *khapra* when it is large with a wide mouth, and **खपड़ी** *khapri* when it is smaller. The latter is also called north of the Ganges **कुडा** *kūda* or **कूड़ा** *kūra*, to the west, and **तौला** *taula* to the east.

438. The iron *spoon* for taking out the hot sand is **कलकुल** *kalchhul* in Sāran and Champāran and South Munger, and **कलकुला** *kalchhula* in Patna and Gaya. In Shahabad it is **कलुह** *kaluchh* or (in the south-west) **कलुस** *kalus*. In South-East Tirhut it is **सरहिया** *sarahiya*. In South-East Bihār it is called **डब्बू** *dabbu*. When made of earth with a bamboo handle it is called **धकनी** *dhakni* north of the Ganges and in South Munger, or **सरवा** *sarwa* in North-East Tirhut.

439. The flat wood *stirrer* is called **दबिला** *dabila* to the west. In North Tirhut it is **दबिया** *dabiya*, and in South-East Tirhut **दाब** *dāb*, and in Gaya **कुरूर** *kurūr*. A kind of broom made of four or five reeds tied together is **झारु** *jhāru* (Patna and Gaya), **भुंजनाठी** *bhunjnāthi* or **बोहनी** *borhni* to the south-east, **बरनी** *barhni* to the east generally, **सरना** *larna* or **लारुनि** *lārani* in North-East Tirhut, **छिपनी** *chhipni* in South-East Tirhut, and **चलौनी** *chalauni* north of the Ganges.

440. The *sieve* is **चलनी** *chalni* generally, but **चलना** *chalna* in South-West Shahabad and **चालनि** *chālani* in East Tirhut. To the west it is also **झरना** *jharna*, and also in South-East Tirhut **रूप** *sūp*.

441. The *poker* is खोरना *khorna* or खोरनी *khorni* north of the Ganges and in South Bhagalpur and South Munger; elsewhere south of the Ganges it is खोड़ना *khorna* or खोड़नी *khorni*. In South-East Tirhut and Champāran it is खोरनाठी *khornāthi*.

442. The *basket* for the grain is north of the Ganges दौरा *daura* or दौरी *dauri*. South of the Ganges we have बटरी *batri* in Patna, मौनी *mauni* or मौनिषा *mauniya* in Gaya and South Munger, भौंकी *bhaunki* in Shahabad, and दलिया *daliya* in Champāran and South Bhagalpur. In Champāran and Gaya the सतघरना *satgharwa*, and in South Munger the चाँड़ *chānr*, is an earthen vessel with seven or more divisions for various kinds of grain, and in South-East Tirhut a बैठकी *baithki* is a similar one with four divisions, and चन्ना *chhanna* one with six. कोहा *koha* or कंटिया *kantiya* in North-East and South-West Tirhut, and करना *karwa* in Champāran, are earthen pots for grain, and कठरा *kathra* in Patna and Gaya, or कठौती *kathauti* elsewhere south of the Ganges, is a wooden pan.

443. The *grindstone* is जाँता *jānta* or (in South-West Shahabad) जाँत *jānt*. Its axle is किला *killa* or (in South-East Tirhut) कौल *kil*, and it is made to revolve by a handle, which is हथरा or हथड़ा *hathra* generally, and जूषा *jūa* to the west, also हाथर in South-East Tirhut.

444. The *wages* in grain paid to the grain-parcher is भार *bhār*, or in South Bhagalpur भारो *bhāro*, as in the proverb जौ जरि नेल, भार जा बाबल जौ *jau jari gel, bhār la bānhal chhi*,—the grain-parcher has burnt my barley and has tied me up for his fee (adding insult to injury). The quantity of grain parched at one time is घानी *ghāni*.

CHAPTER V.—THE BAKER.

445. The baker is generally नानगार *nānbāi*, with a local variant ननगार *nanbāi* in Shahabad. In Gaya he is नानगपज *nānpaj*. He is also called रोटीवाला *rotiwāla*. He is proverbially a rude fellow, and नानगार के खिन्ना *nānbāi ke khinga* is popularly used to mean a stout rude fellow.

446. He uses an *oven*, तनूर *tanūr* or तँदूर *tandūr*.

447. His *roasting-spit* is south of the Ganges सौंख *sinkh*, and elsewhere सौख *sikh*. In North-East Tirhut it is also सौंख *sinkh*. This is fixed on supports, which are खिन्ना *khichha* to the west of the North Gangetic tract and in Patna, and कवाब दानी *kawāb dāni* in South-East

Tirhut, Shahabad, and South Bhagalpur. In Gaya they are चक्क चक्का *chakkas*.

448. The *boiling-pot* is देगची or डेगची *degchi*. South of the Ganges and to the west it is also called पतीली *patili* when made of earthenware.

449. The *cup* is रिकारी *rikābi*, the *saucer* रिकारी *rikābi* or कटोरा *katora*, and the *wooden spoon* दोर *doī*, and also in East Tirhut चमच *chamach* or (to the west) चम्मच *chammach*.

450. The large wooden *stirrer* is called कफचा *kaphcha* in North Bihār, दोषा *doā* in North-East Tirhut, and डोंगा *donga* in South Tirhut. In Patna it is दाभा *dābha*, and elsewhere south of the Ganges डबू *dabbu* when made of iron, or कफगीर *kaphgir* (west generally) when made of wood.

451. The *cushion* by which he places the cake on the side of the oven is रफीदा *raphīda*, or in North-East Tirhut गद्दी *gaddi*. The हशतगना *hushtagna* is an iron *bar* hooked at the end, and the अररा *arra* an iron bar flattened at the end. They are used in taking cakes out of the oven. The one is held in one hand, and the other in the other. The two together are called जोड़ी *jori*, or in Champāran कन्सी *kansi*.

452. The *instrument for making ornamental marks* on pastry is north of the Ganges साँचा *sāncha*; south of the Ganges it is चोकन *chokan* in Shahabad, चोकनी *chokni* in Patna, and elsewhere चोका *choka*.

453. The खुरचनी *khurachni* is an implement for cleaning vessels.

CHAPTER VI.—THE CONFECTIONER.

454. The confectioner is हलुवार *haluāi* in North, and हलुवारा *haluāi* in South Bihār. His *fireplace* is चूल्हा *chūlha*, and also in Champāran and South Munger भट्ठी *bhatthi*, of which the stoke-hole is मुँह *munh*, and also in Gaya and South-West Shahabad दुवार *duār*.

455. His open *cauldron* is कड़ाही *karāhi* generally, also कड़ुवार *karhāi* or तावा *tāwa* in Gaya. Of this the handles are डन्डी *danti*, कड़ा *kara*, or कन्ना *kanna*, with a variant कड़िया *kariya* in South Munger.

456. The *skimmer* is जरना *jharna* in Patna, the north-west, and East Tirhut, चनाउता *chanauta* generally north of the Ganges, पाँना *pauna* in the north-west, Tirhut, and south of the Ganges. In Patna it is

also पौनिया *pauniya*, in South Bhagalpur चट्टी *chatti*, and in Gaya, South Munger, and Sāran झंझरा *jhanjhra*. The large stirrer is केँचोचा *keoncha*, and the small stirrer चोखनी *chholni*. In Champāran and North Tirhut it is also खुरपी *khurpi*, and in South Bhagalpur खुरचनी *khurchani*.

457. The wooden rolling-pin is बेलना *belna*, which is worked on a paste-board. This latter is called चकला *chakla* when it is round, and चौकी *chauki* or पट्टरा *patra* when it is oblong. Other names are तखना *takhta* (North-East Tirhut), पिन्धिया *pirhiya* (Gaya and South Bhagalpur), and पीड़ा *pirha* (Gaya and South Munger). The pestle for beating the dough is दाबा *dāba*, (South-West Shahabad) दापी *dāpi*, or (North-East Tirhut) दाब *dāb*. Other names are गुरदम *gurdam* or मुसद *musad* (Champāran), डपटन *daptan* (Patna), and मुंगरा *mungra* (South Bhagalpur).

458. The spoon is कल्लहुल *katchhul* or in North-East Tirhut कचह *karuch*. The brass ladle with a wooden handle for removing the sugar from one vessel to another is डब्बू *dabbu*.

459. The wooden platter for sweets is गिरदा *girda* north of the Ganges and in Shahabad, खोनचा *khoncha* north of the Ganges and in Gaya and South Munger, खानचा *khāncha* in South Bhagalpur, and खौचा *khāncha* or डगरना *dagarna* in Patna and Gaya.

460. The brass salver is थारी *thāri* generally, with local variants थरिया *thariya* in Shahabad and East Tirhut and थाल *thāl* in Champāran and East Tirhut. In Sāran and Tirhut it is also called चौपा *chhipa*. The deep brass pan is परात *parāt*.

461. The sweetmeats are exposed on stands called तरौनी *tarauni*, local variants being तरौना *tarauna* in Champāran and South-East Tirhut and तरैनी *taraini* in Champāran. In South Bhagalpur they are टेखनी *tekhti*.

462. He has also a wooden basin, called कठरा *kathra*, कठवत *kathwat*, or कडौती *kathauti*; a large ladle, डोहरी *dohri*; and a pair of scales, called generally तराजू *tarāju*, तरजूर *tarjuī*, or टेकौरी *tekauri*. It is also टेकौरी *takauri* in Tirhut and the west, and नरजा *narja* in Champāran.

463. बलुषार के दोकान, दादा के फतेहा *haludī ke dokān, dādā ke phateha*, is a well-known proverb. A *phateha* is a feast in honour of the dead, at which sweetmeats are given away for nothing. When a person wants to get a thing for nothing, which he has no right to expect, the proverb, which means 'a confectioner's shop is not my grandfather's funeral feast,' is said to him.

CHAPTER VII.—THE TOBACCO MANUFACTURER.

464. The tobacco-seller is तमाकुवाला *tamāku-wāla*, तमाकुफरोर *tamāku-phārosh*, or तमाकुलवाला *tamākul-bāla*. He uses a crushing-lever, डेंकी *dhenki*, with a peg, दूसर *mūsar*, मुसरा *musra*, or समथ *samāth*, fixed in it. It is supported on pillars, खूंट *khūnta*, खुण्टा *khuntā*, or (in the west) जङ्घा *jangha* or जङ्घिया *janghiya*, by an axis-pin, किला *killā* or अखाता *akhautā*. It falls on a hollow bed called खोचरी *okhri* or खोचली *okhli*, on which the tobacco is placed. When the crushed tobacco is being removed, the beam is supported by a forked stick, which is called टेकनी *tekni*, टेकानी *tekāni*, or (in Shahabad) टेका *theka* or टकवा *thakwa*, or in Sāran टेकवा *thekwa*. In East Tirhut it is called टेकनी *thekni* or अलगनी *alguni*, in Champāran अरगनी *argani*, and in South Bhagalpur डेंगना *thengna* or उचकुन *uchkun*. Sometimes a string, रसी *rassi*, is used for this purpose. An illustration of the similar crushing-lever used in pounding bricks will be found opposite § 431.

465. The fragments of tobacco are collected by a broom, झाड़ू *jhārū* or बड़नी *barhni*, which is also called कूची *kūnchi* or कूचा *kūcha* towards the west and खरहरा *kharhara* in Patna. The tobacco is sprinkled with water from a water-pot, called पनखटा *panhanda*, हँडिया *hanriya*, कड़ाही *karāhi*, पियाला *piyāla*, मटकुरी *matkuri*. In East Tirhut it is called अथरा *athrā*.

466. The balls of manufactured tobacco are generally पिलण्डा *pilunda* or धोंधा *dhōndha*. Other names are लोहिया *lohiya* (Champāran), गोला *gola* (Sāran and the East), लोंदा *londa* (South Munger and North-West Tirhut), लिट्टी *litti* in Patna and South Munger, and पिण्डा *pinda* in Shahabad. टिकरी *tikri* are smaller balls.

467. In a tobacco shop the broad flat metal plates are, north of the Ganges, सेनी *seni*, and south of it खानचा *khāncha* or खोनचा *khoncha*. The tobacco-pots are भौंड़ा *bhānra*, चरवा *charua*, or चरई *charui*. The cloth covering the stand for the vessels is खरवा *kharua*, ज़ांप *jhāmp*, or परदा *parda*, and the board on which the tobacco is mixed is पट्टा *patra* or पीड़ा *pirha*. When of stone it is पटिया *patiya*. Instead of पीड़ा *pirha*, पिडिया *pirhiya* or तखता *takhta* may be used.

468. Among the spices used in manufacturing tobacco are जटा मसी *jatu masi*, चड़ीला *chharīla*, सुगन्ध वाला *sugand wāla*, and सुगन्ध कोकिला *sugand kokila*. Plain tobacco is called सादा *sāda*, that which is spiced or scented खंबीरा *khambīra* or खमीरा *khamira*, and a mixture of the two दोरस *doras* or दोरसा *dornsa*.

CHAPTER VIII.—THE PIPE-MAKER.

469. The maker of *gurguris* (*vide post*), who is a कसेरा *kasera* or brazier, uses a kind of *lathe*, which is called खराद *kharād*. Of this खूँटा *khūnta*, or in South Bhagalpur कुन्द *kund*, is the block which holds one end of the stem as it is being turned. In it is fixed an iron spike called गूँज *gūnj*. फरन्ही *pharhi* is a piece of iron which keeps the stem in its place as it is being turned, and बघेली *bagheli*, or in South Bhagalpur बघैला *baghaila*, is a piece of wood through a hole in which the stem is passed during the operation.

470. The workman uses the *revolving awl*, बरन्मा *barma*, moved by a bow, कामानी *kamāni*, of which the string is तसन्मा *tasma*, डोरी *dori*, or जोती *joti*; a broad chisel, चौरन्वा *chaurva*, and a narrow gouge, नहरन्नी *naharni*, or in South Bhagalpur नेहनी *nehni*; an *adze*, बसुला *basula*; a small saw, आरी *āri*; a knife, छुरी *chhūri*; and files, रेतनी *reti*.

471. The maker of hubble-bubbles (नरियरन्वाला *nariyarwāla*) uses a रेतनी *reti* (of which the point is हूर *hūr*), आरी *āri*, बरन्मा *barma*, and गज *gaj*.

472. The pipe (हुक्का *hukka*) is of various kinds—

- (1) The नरियर *nariyar* or नरियाल *nariyal*, which is the ordinary country hubble-bubble, in which the mouth is applied to the cocconut itself. It is smoked principally by Hindus. Of this the stem bearing the bowl for burning the tobacco is बोता *bota* or गद्दा *gatta*. The short smoking-stem sometimes applied to the cocconut, to save the hands from being blackened, is निगाळी *nigāli* or नर *nar*. The bowl is चिल्लम *chillam* or चिल्लन *chilam*. In South Bhagalpur पोंगी *pongi* is a temporary pipe made of the leaf of a tree. In South-West Shahabad दम्मी *dammi* is a wooden pipe used by travellers, and दमदमाचा *damdamācha* a pipe used by women.

473. (2) The other kinds stand on the ground, and are more or less similar to each other in shape. The general name is गुरगुरी *gurguri* when the smoking stem is joined to a tube rising from the brass bowl, and गगगुवा *gargava* when it issues directly from the brass bowl. They are generally made of metal or earth. Another name is फरन्ही *pharsi*. The tube arrangement for carrying the

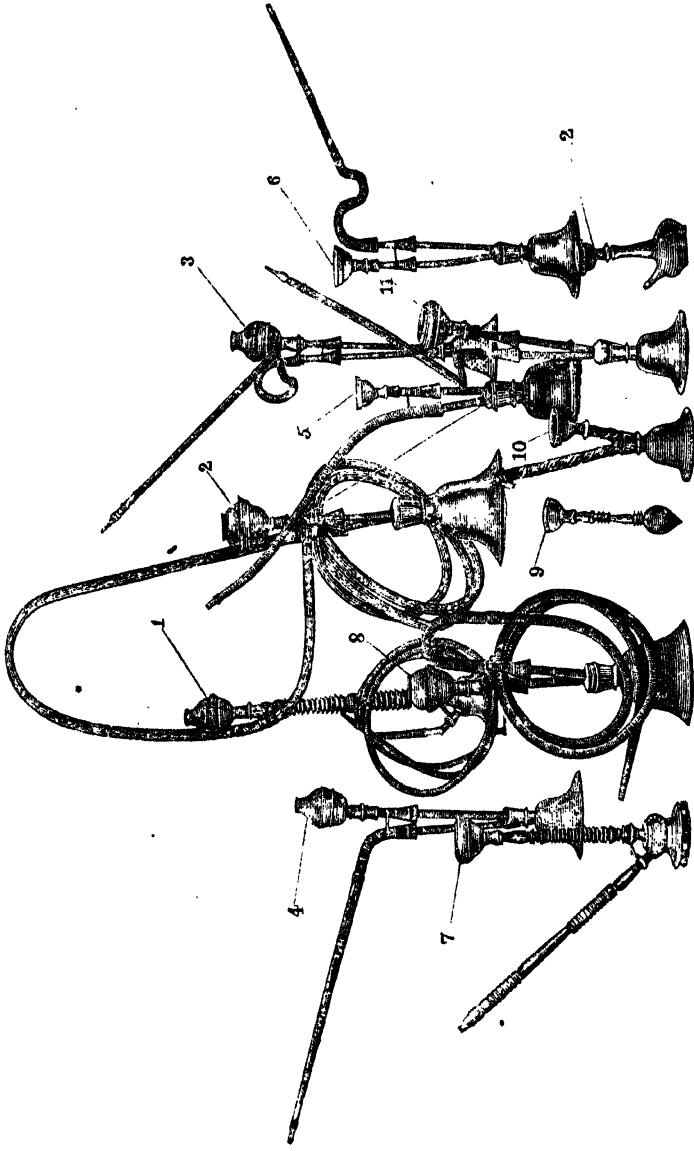

A collection of pipes.

- | | | |
|-------------------------------|----------------------------|-------------------------------------|
| 1. <i>Fenchdār gargara.</i> | 5. <i>Simple chaugāni.</i> | 9. <i>Hubble-bubble or nariyar.</i> |
| 2. <i>Satak or penchawān.</i> | 6. <i>Arhūi khāmā.</i> | 10. <i>Tharhiya.</i> |
| 3. <i>Jilebiya kulphidār.</i> | 7. <i>Simple gargara.</i> | 11. <i>Kekuniār.</i> |
| 4. <i>Kulphidār chaugāni.</i> | 8. <i>Phatak pench.</i> | 12. <i>Gauraiya.</i> |

bowl is the same in principle as in the cocoanut kind. The difference is in the smoking-stems (नेचा *naicha*).

Of these there are—

- (a) कुलफ़ीदार *kulphīdār*, that with joints (कुलफ़ी *kulphi*), allowing the mouth-piece to be moved in any direction. A कोऊनीदार कुलफ़ी *kochanīdār kulphi* is a joint like an elbow, and a जिलेबिया कुलफ़ी *jilebiya kulphi* is a twisted joint.
- (b) अदाद खन्दा *arhāi khamha*, that with two large bends and one small one.
- (c) डेरु खन्दा *derh khamha*, that with two bends.
- (d) ठहिया *tharhiya* or ठहिया *thariya*, with a short straight stem—used only by poor Masalmāns.
- (e) चाोगानी *chaugāni*, the simplest kind—used by the poor.
- (f) गौरैया *gauraiya*, a simple kind, made of pottery.
- (g) लटक *latak*, which bends downwards.
- (h) चहलेदार *chhalledār*, ornamented with gold or silver rings (चहला *chhalla*).
- (i) सटक *satak*, पेचवान *pechwān*, पेचदार *penchdār*, or फतह पेच *phatah pench*, are various kinds with the long, snake-like, flexible tube.

CHAPTER IX.—THE PIPE-STEM MAKER.

474. The pipe-stem maker (नेचाबन्द *naichāband* or नेचाबन *naichāban*) uses an *awl*, गज *gaj* or (in Patna) सौंख *sīnkh*; a *polishing-knife*, हुरी *chhūri*; a pair of *scissors*, कैची *kainchi* or मेकराज *mekraj*; a *saw*, आरी *ari*; and a pair of *tweezers*, मोचना *mochna*. He also uses तरन्दा *tarla* or reed, and चीन *chīn* (*Panicum miliaceum*), a superior kind which comes from Sylhet.

475. For making the longest snake-like stems, पेचवान *pechwān*, a board (तखता *takhta*), a string (डोरी *dori*), and a mould (कालिब *kālib*), are also used. The embroidered work on a pipe-stem is called in South Bhagalpur पानन्दार *pāndār* or मोरसा *morassa*. The silk work on it is सरासर *sarāsar* or भरावट *bharāvat*, the flowered silk work on it बुडी *būḍi*, the silver work on it अलफ़ी *alphi*, and the ornamental cloth work, उल्लि चीन *ulli chīn*.

CHAPTER X.—THE COTTON-CARDER.

476. The cotton-carder is धुनिचाँ *dhuniyān*. For a description of him and his instruments, see § 334 and ff.

477. In addition may be mentioned the पटका *patka*, which is an instrument for teasing cotton. It is also called गज *gaj* in Tirhut, Shahabad, Gaya, and South Bhagalpur, and साटी *sāti* in Champāran and Shahabad. The फटका *phatka* or फटकी *phatki* is a simple bow used by village women for carding cotton.

478. A lion once met a cotton-carder in the forest, and seeing his carding-bow, mistook him for a hunter. To avoid being killed, the lion addressed him चाये घटुही कान्हे बान, कहाँ चले दिह्नी दुलन्तान *hātke dhanuhi kānhe bān. kahān chalc Dilli Sultān*,—with bow in hand and arrow on shoulder, where is the emperor of Delhi going? The cotton-carder was equally frightened, but at length mustered courage to reply बन में रहना बन में खाना बड़े के बात बड़े पहचाना *ban men rahna, ban men khāna, bare ke bāt bare pahchāna*,—although he live and eat in the forest, only a gentleman can recognise a gentleman. These sayings have passed into proverbs, the meaning of which is obvious.

CHAPTER XI.—THE SHOE-MAKER.

479. The shoe-maker is मोची *mochi* or मोँची *monchi* in cities, and चमार *chamār* in the country. Among his tools are—

480. The thick iron *pounder* for joining the edges of two pieces of leather which have been previously smeared with paste, which is लोहिया *lohiya* north of the Ganges generally, also लहाँगा *lahaunga* to the west of that tract, and पिटना *pitna* in North-East Tirhut. In Patna, Gaya, and South-West Shahabad it is लोहङ्गा *lohanga*, and in the rest of Shahabad and in South Bhagalpur it is लोहोंगा *lehonga* or टिपना *tipna*. In South Munger it is सिंगठा *singtha*. The paste used is लेर *lei*, or to the south-east लर *lai*. In South-East Tirhut it is खरी *khari*. लसम *lasam* is a similar paste made of pounded boiled rice.

481. The *knife* for scraping the surface of the leather is in North-West Bihār रँपी *rāmpi* or रापी *rāpi*. In Tirhut, the west, and South-East Bihār it is also खुरपी *khurpi*. In Gaya it is खुरपा *khurpa*, and in Patna रम्पा *rampa*.

482. The large *awl* is सुतारी *sutāri*, with a variant सुताली *sutāli* in Gaya. To the east it is also लोखर *lokhar*, in Champāran लांखर

lākhhar, and in South-East Tirhut चार *ār*. The awl with a hook at the end for sewing is कटरनी *katarni*. In South Bhagalpur it is डकना *takna*, and in South Munger टिपुनी *tipuni*. The medium-sized awl is मँभोला *manjhola* or मँभोली *manjholi*.

483. The *horn* for grease is सिङ्गा *singa*; south of the Ganges, it is also सिङ्ग *singh*.

484. The *last* is फरना *pharma* or (north of the Ganges and the South-East) कलबूत *kalbūt*; south of the Ganges it is also, in Gaya, काँलबूद *kālbūd*, and कलबूद *kalbūd* elsewhere.

485. The *wedges* of wood or leather fastened to the last to make it fit are परन्तहा *partaha* (also in South Munger), or परन्ताहा *partāha* in Shahabad, and पची *pachchi* in the south-west of the same district. In South Munger they are कपन्हेरी *kapchheri*.

486. The *chisel* for paring the edges of the sole is खुरपी *khurpi*. The sort of wooden chisel for smoothing the surface of the leather is बँग *benga* to the east, बेङ्गा *beūnga* north of the Ganges, or बेचोंग *beonga* or बेचोंगी *beongi* elsewhere south of it. In South Bhagalpur it is पेलन *pelan*.

487. A wooden *block* for beating the leather is हॉमर *hāmmar* in South Munger and Gaya and घामँड़ *ghāmanr* in South-West Shahabad. The *block* on which the leather is out is पिहिचा *pirhiya*, or in South Bhagalpur सिहा *silla*, and in Saran पिरन्ही *pirhi*.

CHAPTER XII.—THE BLANKET-WEAVER.

488. The blanket-weaver is गड़ेरी *gareri* south of the Ganges and भँडिहर *bhenrihar* north of the Ganges; also in East Tirhut मड़ड़ *marar*.

489. He uses a simple *loom*. The stick on which the blanket is wound as it is woven is ओखर *oknar* south of the Ganges. North of the Ganges it is सिँजोय *sinjoy*, also सिँजो *sinjo* in Tirhut and कमन्हर *kamhar* in Champāran. The supports for this beam are खुँटी *khutti*, खूँटी *khūnti*, or (in Gaya and East Tirhut) खूँटा *khūntā*. In South-East Tirhut they are also गाली *gāli* and गल्ली *galli* or गलियारी *galiyāri* in Champāran. In Shahabad the left support is called बरनी *barni*, and the right hand one गाली *gāli*. In the same district the support furthest in front of him is धूरा *dhūra*, and in Champāran धूर *dhūi*.

490. The *beam* to which the web is fastened at the opposite end from the weaver is ओचारी *ohāri*. बँ *ben* or बँव *beno* is a wooden imple-

ment which is passed between the thread of the web to drive tight each thread of the woof. In South-East Tirhut it is also called **बथा** *hatha*.

491. The *movable sticks* placed at intervals to separate the threads of the web are **तगधरी** *tagdhari* in Tirhut and Sāran and **बैलठ** *bailat* elsewhere, except **बैलठ** *bailath* in Shahabad and **बरत** *barat* in Champāran.

492. The *heddles*, or implement for alternately raising and depressing the threads of the web, are **चपनी** *chapni*; also in South-West Tirhut **फडी** *phatthi*.

493. The wooden *scraper* for removing knots or excrescences from the thread is **खिखोरना** *khikhorna* or **खिखोरनी** *khikhorni* north of the Ganges, also **खिधोरना** *khidhorna* in Champāran. In Patna it is **खिलोरना** *khilorna*, and elsewhere south of the Ganges **खिलोरना** *khilorna*.

494. The thick iron *needle* is **सूया** *sūa*, or in South Munger **सूज** *sūj*. The *shuttle* is **सरगाँ** *sargān* in South Munger and north of the Ganges, and **सेरङ्ग** *serang* or **सेरङ्गा** *seranga* south of it.

495. In Sāran and South-West Tirhut the **भाँड़ी** *bhānri* is a thick bamboo which is placed between the two threads of the warp. In Champāran it is **सासन** *sāsāt*, in South-East Tirhut **साँसर** *sānsar*, elsewhere south of the Ganges **साँसन** *sānsat*, and elsewhere **चोंगा** *chonga*.

CHAPTER XIII.—THE FANCY SILK OR FRINGE-MAKER.

496. This man is called **पटवा** *patwa* or **पटहेरा** *pathera*. In Sāran he is called **पटहेरी** *patheri*.

497. He uses the **कतना** *katra* or **कतला** *katla*, a piece of wood with four holes, in which four threads are fixed for winding.

498. The *wooden reel* furnished with a handle is **पटनी** *batni* generally. The *small wooden reel* is **अंटी** *anti* or **चरक** *charakh*. An optional local name is **गडी** *gatti* in South-West Shahabad. **गोली** *goli*, or in Tirhut and South Munger **पेचक** *pechak*, is a ball of thread. The *winding-stick* is **तोली** *toli* in Patna, **बेलन** *belan* in Shahabad, and **लताँ** *latain* in North-West Bihār.

499. His *scissors* are **कैची** *kainchi*. The *coarse needle* for smoothing roughnesses in thread is **सलार** *salāi*, also **टकुवा** *takua* in East Tirhut, and **टेकुवा** *tekua* in Champāran. The *ivory smoother* is **मठार** *mathār*,

or in Sāran सठरन्मा *matharna*. The large *darning-needle* is सूषा *sūa*. The fine needle is सूरि *sūi*, also नमन्मुहिषा *nammuhiya*.

500. The iron *hook* with a ring which goes round the toe is अँकुरा or अँकुडा *ankura*, also अँकुषा *ankusa* and अँकुषी *ankusi* in Gaya and North-East Tirhut. This hook is supported on a stand called थूनु *thānu* in Patna, थौना *thauna* in Gaya, थला *thalla* in South-West Shahabad, थौना *dhauna* in the rest of the district, and थम *tham* to the east generally.

501. The *drum* off which the thread is wound is परेता *pareta*, परन्ता *parta*, or परन्ती *parti* in North-West Bihār. The bamboo frame on which the thread is wound is नटन्वा *natwa* or लटन्वा *latwa*. In Patna it is नटार *natāi*, and in Gaya and the South-East नेटन्वा *netwa*.

CHAPTER XIV.—THE EMBROIDERER.

502. The embroiderer is जग्दोज *jarđoj* or (south of the Ganges) कारन्चोबी बाला *kārchobiwāla*, and he makes embroidery (कारन्चोबी *kārchobi*) on the कारन्चोब *kārchob* or embroidery-frame, on which the work is stretched. This frame is rectangular; and of the parallel pairs of sides, one pair is called (in Patna) समसेर *samsēr* or (in Gaya and the west) समसेरक *samsērak*, and the other तीली *tīli* in Patna, फरद *pharad* in Gaya and Sāran, and पट्टी *patti* in Shahabad.

503. The small *needle* is सूरि *sūi*, and the sewing-awl सुतेमान *sutemān* north of the Ganges, सुतन्वान *sutwān* in Gaya and Shahabad, सूषा *sūa* or बरि सूरि *bari sūi* in Patna, Gaya, and South Munger.

CHAPTER XV.—THE DYER.

504. The *dyer* is रंगरेज *rangrej*, in opposition to the रंगषाज *angšāj* or painter. In North-West Bihār he is called रंगरेजी *rangreji*.*

505. He uses a *vat* or pot sunk in the ground for his dyes. This is called north of the Ganges माट *māt*. In Patna it is माँट *mānt*, and to the east माठ *māth*. In Shahabad it is चोंड़ *chhōnr*, and in the south-west of the district कुण्डा *kundu*. In Gaya and East Tirhut it is कुँड़ *kūnr*, and in South Bhagalpur and East Tirhut गोली *goli*.

* This word is often confounded with the word अँगरेजी *Angreji* 'English'; and in jest, or when speaking facetiously, the English in India are called रंगरेज *angrej*, or 'dyers.'

506. His *half-round pot* is अथरा *athra* or नाद *nād* north of the Ganges, in Shahabad, and South Munger. In South-East Tirhut and South Munger it is also called कड़ाही *karāhi*. In Patna and Gaya it is हॉड़ी *hāuri*, and in South Bhagalpur कड़हार *karhāi*.

507. The wooden *filter-frame* on which the cloth is hung like a bag with the dye inside is मँजी *mānji* or मञ्जी *manji* generally. In South-West Tirhut it is मिरन्हा *mirla*, in North-East Tirhut झोरो *jhori*, in Gaya मँजी *mānji*, and in South Bhagalpur चम्मल *chammal*. The string tied to the cloth is कसन *kasān*, and the cloth with the dye inside it in South Munger and Patna फुलगरना *phulgarna*.

508. The *stirring-stick* for mixing the dyes is दण्डी *dandi*, or in South Munger दण्टा *danta*, in South Bhagalpur टेख्ती *tekhti*, and in North-East Tirhut लरना *larna*.

CHAPTER XVI.—THE WOOD-PAINTER.

509. The wood-painter is रँगसाज *rangsāj*, as distinct from the रँगरेज *rangrej* or dyer. He uses two kinds of *paints*—one अस्तर *astar*, which is a paste made up with chalk and gum, and the other रोगन *rogan*, which is made up with resin and oil.

CHAPTER XVII.—THE TIN-MAN.

510. The tin-man (कलेगर *kalaigar*) uses a *bellows*, called भाथी *bhāthi* south of the Ganges and in East Tirhut; elsewhere it is called धौकनी *dhaukni*. Another name current south of the Ganges is एक-दण्डू भाथी *ekhatthu bhāthi*. The two sticks used as handles are north of the Ganges and in South Munger हथी *hatthi* or हथू *hatthū*, and south of it, and also in Tirhut, दण्टा *danta*. In South-East Tirhut they are also हत्था *hattha*. The bamboo pipe is चोंगा *chonga*, also in North-West Tirhut नरौवा *naraua*, in Gaya and Shahabad नराँ *narāün*, and in South Bhagalpur चोंगी *chongi*.

511. The *solder* is रँग *rānga*, and the soldering-iron कैया *kaiya*. He also uses cotton-wool, रुई *rui*, and pincers, सरसि *sarsi* or सँसुसी *sanrsi*. The ठिकड़ा *thikra* or खोरिया *khoriya* is the flat tile for melting the solder.

512. The *tin-cutter* is कैंची *kainchi*, and he also uses the small *hammer*, हथौरी *hathauri*, and the *compasses* परन्कास *parkāl*. The *tin-scraper* is नेहनी *nehni* or लेहनी *lehni*; also खुरचुनी *khurchuni* in South Bhagalpur.

513. The सबरा *sabra*, सबरी *sabri*, or (in South Bhagalpur) बाबल *abal*, is a small kind of *anvil*, made of a bent piece of iron, with one end pointed and stuck in the ground.

CHAPTER XVIII.—THE JEWELLER.

514. The jeweller is सोनार *sonār*, or in Gaya सोनी *soni*. In Champāra and North-West Tirhut he is सोनगढ़ुवा सोनार *songarhua sonār*.

515. Amongst his implements are the *tongs*, which are सँडुन्सा *saurisa* or सँडुन्सी *sanrsi*.

516. The *pincers* have various names. Large pincers are चिमन्टा *chinta* in South-West Tirhut, also सेहूना *sehuna* generally to the west; सोहना *sohna* to the east and in Gaya, and चूँटा *chūnta* in Patna. Smaller ones are चिमन्टी *chinti*, सेहूनी *sehuni*, सोहनी *sohni*, or चूँटी *chūnti*. Another kind is गडुवा *gahua*, which are the large pincers. Nippers are गडुई *gahūi*, or in South Bhagalpur गडुली *gahuli*. The कगन्सुही *kugmuhān* are nippers twisted at the head for holding the crucible in the fire. These may also be called बगसँडुन्सी *bagsanrsi* in North-West Bihār and बगन्सुही *bagmuhān* in Tirhut and Champāra.

517. The जमुरी *jamūra* or जमुरी *jamūri* are *wire drawing-pincers*, and the perforated wire plate is जन्नी *jantri* south of the Ganges, in North-West Bihār, and East Tirhut, जैन्नी *jaintri* north of the Ganges generally, and जतररी *jatri* in Champāra and North-East Tirhut.

518. The iron needle-shaped tool for making links of chains is टेकुली *tekuli* to the north-west, टकुवा *takua* to the east and south-west, टेकुवा *tekua* in Sāraṅ, Patna, and Gaya, and टेकुरी *tekuri* in South Bhagalpur.

519. The *compasses* are परकाल *parkāl* or कम्पास *kampās*, or in South-West Shahabad चलाईकी *chalānki*.

520. The *chisel* with a round knob for embossing circular ornamentation is खलनी *khalni*, or in Tirhut खोलनी *kholni*.

521. The *cold chisel* is चेनी *chheni*, and a smaller variety is कलम *kalam* south of the Ganges.

522. The *cutters* are कैची *kainchi*, and also to the south, except Patna, कतरनी *katarni*.

523. Amongst *hammers* हथौरा or हथौड़ा *hathaura* is the largest. The medium-sized is मरिया or मड़िया *marīya*, with a variant मरेवा *mareva* in North-East Tirhut; in Gaya it is मठरनी *matharni*. The smallest

is गोलमुहँ *golmuhān* or गोलमुहँ *golmuhān*; another name is खोलनरिया *kholmariya* in East Tirhut.

524. The small pointed *anvil* is समदान *samdān*. The curved anvil is एकवार *ekwāi*, or in East Tirhut एकाने *ekābe*.

525. The bell-metal *anvil* sunk with several depressions for making *repoussé* work is कंसला *kansula* in North-West Bihār, कंसला *kansla* in East Tirhut, कंसुला *kānsula* in South Tirhut, कंसला *kānsla* in South-West Bihār, and कसला *kasla* in South Bhagalpur and South Munger.

526. The square-headed *anvil* is निहार *nihāi*, or in Champāran and North-East Tirhut नेहाए *nehaē*, and नहार *nahāi* in South-East Tirhut. In South Bhagalpur it is लिहार *lihāi*.

527. The *anvil blocks* sunk in the ground are चाहा *chāha* in Sāran and South-West Shahabad. In Champāran and West Tirhut they are टेहा *theha*. In Shahabad they are एकठा *ektha*. In Patna, Gaya, and Tirhut they are परकठ *parkath*, and in South-East Tirhut also पिरगिठी *pirgithi*.

528. The *blow-pipe* is बकनार *baknār*, or in Sāran बकनल *baknal*.

529. The hollow *cane for blowing* up the fire is नारी *nari*, with local variants नारी *nāri* in Gaya, लारी *lāri* in North-East Tirhut and South Bhagalpur. In South-East Tirhut it is optionally फुकाठी *phukāthi*. The *fireplace* is अंगैठा *anguītha* north of the Ganges and अणैठा *angetha* south of it. Another name for this last is बोरन्डी *borsi*. The *fan* for blowing up the fire is पन्हा *pankha* or पन्ही *pankhi*; also in South-West Shahabad it is बेनियाँ *beniyān*. In North-East Tirhut भट्टी *bhatti* is the dry powdered earth used for cooling the hot metal.

530. The small clay *crucible* is घड़िया or घरिया *ghariya*. It is made of a mixture of clay and rags called in Shahabad कपन्नीट *kampnūt*, and in Champāran कपन्नीट *kapnūt*.

531. An *ingot* not beaten out is कानी *kāmi*, or in Gaya एकवार *ekwāi*. In Sāran it is थक्का *thakka*, in Champāran and North-West Tirhut चल्की *chhalki*, South-East Tirhut गद्दी *gaddi* or थोक *thak* (also in South Munger), in South Bhagalpur थोक *thauk*, and in Tirhut generally except the north-west चिल्की *chhilki*. A block of silver beaten out flat is चौरसा *chaursa*.

532. The iron *ingot mould* is परगहनी *pargahni* to the west and परगनी *parghani* in Patna and Gaya. In East Tirhut it is डारा *dhāra*, in Sāran कन डारा *kam dhāra*, and in South Bhagalpur नाली *nālī*.

533. The *moulds* of various sizes into which metal is beaten are कठकिरा *katkira* north of the Ganges, कठकिरा *kathkira* south of it to the east, ठसा *thassa* in Saran, and ठप्पा *thappa* in Gaya and Shahabad. In Shahabad similar moulds are बहका *bahka*, लहरिया *laheriya*, गोकुल *gokhlu* (also in South Bhagalpur), and मोतिया *motiya*. To the west रहठनार *rahatwār* is a mould in which round articles are beaten into shape, and गुंजरी *gunjri* is a similar smaller one. In the same tract पगन्ही ठसा *pagri thasa* are milling moulds, such as those in which the edge is given to a rupee. These last are called in South Bhagalpur खीरा बिच्चौ *khira bichchi*, बाँह *bānh*, or पगन्हा *pagra*.

534. *Pattern stamps* for ornaments are ठोंसा *thonsa* in Shahabad, ठसा *thāsa* in Gaya and South Bhagalpur, ठॉस *thāns* in Patna, and चपा *chhāpa* in South-West Shahabad and South Munger.

535. The कटोरी *katori* is a box or cup for holding scraps of silver. In North-East Tirhut it is called डिविया *dibiya*, and in Tirhut and to the east सिमुहा *situha* or रंगेश्वरी *rangeshri*.

536. The *polishing-brush* is बरींही *baraunchhi*. In South-East Tirhut it is also called कुची *kuchhi*. The polishing stone is ओपनी *opni* or पोन *pot*.

537. The *touch-stone* is कचौटी *kasanti*. A *jeweller's wages* is गहार *garhāk*.

CHAPTER XIX.—THE LAPIDARY.

538. The lapidary is बहाक *hakkāk*, or in South Bhagalpur मोहली लोहार *mohli lohār*, and he uses a revolving *grindstone* or सान *sān* or in Shahabad चकर सान *chakar sān*, made of corundum powder and lac. The bow for turning this is कमाना *hamāna* or (to the west) कमानौ *hamāni*. Its props are खूँटा *khunta*, देवाली *dewāli*, or एकठा *ektha*. Its wooden axle is साँखा *sānkha* in Patna and Gaya, लट्टू *lattu* in Shahabad, and कून *kūn* to the east.

539. The agate *burnishers* are घोंटा *ghonta*, and the round ones सिल्ली *silli*; the *pincers*, चूँटी *chūnti* in Tirhut, Patna, Gaya, and the east, चिमन्डा *chimta* in Saran, and सड़नी *sehuni* in Shahabad; the iron *graver* is सलार *salāi*; the *cutters*, केँची *kainchi*; the small *hammer*, चयौरी *hathauri*; the *anvil*, निहार *nihāi*; the *pincers*, सँडनी *sansri*; and the revolving *awl* जिला सान *jilā sān* or खर सान *khar sān*.

CHAPTER XX.—THE SEAL-MAKER.

540. The seal-maker is मोहरकान *moharkan*, and he uses a machine called a चरक *charakh*, of which the principal portion is a revolving awl, बरमा *barma*.

541. The hammer which he uses is मथनी *mathni* or मरिया *mariya*; the stone to which the metal to be engraved is fastened is डेमा *dhema*; and the diamond pen is कलम *kalam*.

CHAPTER XXI.—THE GOLD-WASHER.

542. The gold-washer is called निचरिया *niyariya* or नियारिया *niyāriya* north of the Ganges and in Patna; elsewhere south of the Ganges he is called सनधोषा *sandhoa*, and South Bhagalpur निचार धोषा *niyār dhoa*.

543. He uses the कठरा *kathra* or wooden pan for washing the ashes of jewellers' shops. Another name current in Patna and Gaya is कठौनी *kathauti*. The ashes are निचारा *niyāra* or नेचारा *neāra*, and they are collected by a scraper, खुरपा *khurpa*, and a broom, कूची *kūchi* or मूठा *mūtha*. South of the Ganges the पखुरी *pakhuri* is an iron instrument for collecting the ashes.

544. His sifting-pan is चहान *chattan*, or in Patna and Gaya धकना *dhakna*. In South Bhagalpur it is चौहटा *chauhatta*.

545. His bellows are भाथी *bhāthi*; his blow-pipe, बकनार *baknār*, or in Shahabad बकनल *baknal*; and the earthen pipe of the vessel which remains in the fire, सुसन्वा *suswa* north of the Ganges and सूंसा *sūnsa* south of it. In Saran it is also नरौसा *naraua*.

546. His pincers are सँडुसी *sansri*, or in North-West Tirhut सनसा *sansa*; and the iron stirrer सीक *sīnk* north of the Ganges and सीक *sīnk* south of it. Another name for the latter is सडार *saldāi* in North-West Bihār.

547. The earthen crucible is गरिया or गरिया *ghariya*, also डीब *dīb* in Patna and Gaya and अडा *adda* in South Bhagalpur. These crucibles are of two kinds: the first only destroys the dirt, leaving all the metals behind, and is called बगलौटी *baglauti*. The second destroys all the baser metals left by the first, and leaves only the gold and silver untouched. It is called पुनहर *punhar*.

CHAPTER XXII.—THE BRAZIER.

548. The brazier is उठेरा *thathera*, but in Shahabad he is also called कसेरा *kasera*, which properly means a brass-founder. In North-East Tirhut he is उठेरि *thatheri*. He is famous for his powers of swindling, as in the proverb उठेरि उठेरि नहिँ बदला होय *thatheri thatheri nahin badla hoy*,—braziers don't traffic with each other (for if they did, it would be diamond cut diamond).

549. He uses the गिहार *nihāi* or नेहाय *nehāē*, or *anvil*. In East Tirhut this is also called लेहाय *lehāē*, and in Patna, Gaya, and South-West Shahabad पथल *pathal*. The समन्दान *samdān* is the pointed anvil, which is also called in Gaya and Shahabad एकवार *ekwāi*. The सवरा *sabra* or, in the south-east साबर *sābar*, is an anvil round at the top. The circular anvil for shaping the mouth of a vessel is चौका *chauka* south of the Ganges and बगलभरुवा *bagalbharia* north of it. South of the Ganges the गेरिया *geriya* (Gaya) or दुगोड़ी *dugori* (west) is a sort of wooden anvil or block. The गोली सवरी *goli sabri* is a kind of anvil for pushing up any indentations. In South Bhagalpur it is called गोलसाबर *golsābar*. The खरने *kharice*, or in Shahabad दबठा *dabtha*, is a kind of anvil on which hollow vessels (गगरा *gagra*) are hammered out. It stands on the two-legged दुगोड़ी *dugori*, also called खराट *kharāt*.

550. The *cutters* are कैची *kainchi*, also कान *kāt* in Gaya and North Tirhut.

551. The *stirrers* are—(a) for stirring solder, कैया *kaiya* south of the Ganges and सरा *sarāi* north of it; also लोपन *lopan* in East Tirhut: (b) the iron stirrer for mixing up the flux, पन्देनी *pandeni* north of the Ganges and Gaya, पेनेनी *peneni* in Shahabad, and पनकाठी *pankāthi* (of wood) in South Bhagalpur.

552. The *pincers* are सन्सी *sansi* or सँइसी *sanrsi*, also गडवा *gahua*; the *file* रेतो *reti*, and the *hammers* हथौरा *hathaura* or हथौरी *hathauri*, also मथना *mathna* north of the Ganges and to the west, मरिया *mariya* in East Tirhut, and घन *ghan* in North-East Tirhut.

553. The *vessel for holding the flux*, सोहागा *sohāga* or पापन *pāēn*, is कठोरी *katori*. In South Bhagalpur it is पनवाला *panwāla*.

554. The *bellows* are भाथी *bhāthi*; the *crucible*, चड़िया or धरिया *ghariya*; the *tongs*, सन्सी *sansi*; and the perforated *cover for the crucible*, ओहार *ohār* north of the Ganges, South Munger, and South-West Shahabad; also जहंप *jhāmp* in South-East Tirhut and South

Munger, **झाँपन** *jhāmpan* or **झाँपना** *jhāmpna* in Patna and Gaya, **चिपौना** *chhipauna* elsewhere in Shahabad, and **करन्धार** *karhāi* or **सुन्दन** *mundan* to the east.

555. The *mallet* is **मुंगरी** *mungri*. The *scales* are **तराजू** *tarāju* or **तरजूई** *tarjūi*. The *polisher* is **चोल्नी** *chholni* or **लेहनी** *lehni*. In South Munger it is also **नेहनी** *nehni*.

CHAPTER XXIII.—THE BRASS FOUNDER.

556. He is **कसेरा** *kasera*, and in Gaya also **तम्हेड़ा** *tamhera*.

557. He uses *moulds* of various kinds, called **साँचा** *sāncha*, or in Shahabad **कमठरना** *kamatharna*. His *lathe* is **खराद** *kharād*, or in Shahabad and South-East Biḥār **कुन्द** *kund*. His large *pincers* are **सैंडसा** *sanrsa* or **सनसा** *sansā*. His *crucible* **घरिया** *ghariya*, of which the mouth is **मुँह** *munh*. His broad chisel is **चौरसा** *chaurisa* or **चौरसी** *chaursi*, also **लेहनी** *lehni* in Shahabad and **चेनी** *chheni* in the south-west of the same district.

CHAPTER XXIV.—THE BRASS BANGLE-MAKER.

558. The brass (**काँसा** *kānsa*) bangle-maker (**ठठेरी** *thatheri* or **ठठेरा** *thatherar*) makes **बाँधी** *bānhi*, which are brass bangles worn by the lower classes. To the east they are called **बतिसी** *batisi*, and in South Bhagalpur **बस्ती** *basti*. When a number of these are worn, those at each end are called **बन** *ban* or (South-East Tirhut) **कचरुकी** *kachrukhi* and (Sāran) **कतरी** *katri*. Of these the one highest up the arm is called **अगुआ** *agua* or **अगेला** *agela*, and that nearest the hand, **पच्छुआ** *pachhua* or **पच्छेला** *pachhela*.

559. He uses the following implements. Variants of the names already given in other chapters will not be repeated here:—

560. **नेहाय** *nehay*, the anvil; **हथौरी** *hathauri*, the hammer; **सैंडभी** *sanrsi*, the pincers; **रेती** *reti*, the file; **चेनी** *chheni*, the cold chisel; **भाथी** *bhāthi*, the bellows; **घरिया** *ghariya*, the crucible; and **डाढ़ा** *dhāra* or **साँचा** *sāncha*, the mould, in which **कामी** *kāmi* is the orifice through which the molten alloy is poured.

CHAPTER XXV.—GLASS-MAKER AND GLASS BANGLE-MAKER.

561. These are the **सीसा धरेवाला** *sisā dharewāla* or glass-manufacturer; the **मनिहार** *manihār*, who makes glass bangles; and the **सुरिहार**

or बुड़ियार *churihār* or बुड़िया *churiya*, who makes the embossed ornaments on glass bangles.

562. Their *furnace* is called मट्टी *bhatthi*, of which the opening through which the melted glass is removed is बारा *bāra* north of the Ganges, मोहरा *mohra* in Shahabad, and elsewhere दरवाजा *darwāja*. This is closed by a cover called अलवारी *alvāri* north of the Ganges and in South Munger, ओलवारी *olvāri* in South-West Shahabad, दपौना *thapauna* in Shahabad, and elsewhere भपना *jhapna*.

563. The earthen *crucible* is ठिकर *thikkar* or ठिकरा *thikra* generally, also कड़ाही *karāhi* in South-East Tirhut, and डिवरा *dibra* in Patna and Shahabad.

564. The *spoon* for putting the glass into the crucible is करन्हुल *karchhul*. The iron *hook* for taking out the glass is अंकुरी *ankuri* or अंकुरा *ankura* in Patna and the west, अकुरा *akura* in South-East Tirhut, हथ अकुरी *hath akuri* in South Tirhut, हथ अकुरी *hath ukri* in South Bhagalpur, and धरन्नी अकुरी *dharni akuri* in Champāran. The instrument for turning the glass in the crucible is अकुरा *akura* generally, and कलन्हुला *kalehhula* to the west.

565. The *stone* on which the ring is shaped is पत्थर *patthar* or पत्थल *patthal* north of the Ganges, and पथरी *pathri* south of it. The *mould* with a handle for shaping the bangle is कांलबून *kālbūt* north of the Ganges, and कलबुद *kalbul* or सँचा *sāncha* south of it. The handle of this is सरकण्डी *sarkandi*.

566. The long iron *poker* on which the glass is melted is सलाग *salāg*; the flat iron instrument for shaping the ring is माला *māla*; and the instrument for widening the ring to the required size बेधवार *bedhwār* in North-West Bihār, बधवारी *badhwāri* in Patna and South Tirhut, and बधरना *badharna* south of the Ganges. The छोटी बेधवारी *chhoti bedhwāri*, &c., or छोटी अकुरी *chhoti akuri*, is the instrument for taking the ring off the mould. In South Bhagalpur it is घरन्नी *gharanni*.

567. *Other instruments* used by the glass bangle-maker are ठिकन्ठी *tikhthi*, which are bamboo slips for holding the bangles in the fire; पन्नी *panni*, leaves of solder; फोकाठी *phokāthi* (Gaya and South Bhagalpur), फौफौ *phonphi* (West Tirhut and South-West Shahabad), or नरी *nari* (Patna, South Munger, Tirhut, and rest of Shahabad), which is the pipe for blowing up the fire; the अंगेठा *angethā* or अंगेठी *angethi*, which is the fireplace; and चून्टा *chūnta* (Shahabad), चुन्टा *chunta* (Tirhut, Gaya, and South Munger), चुन्टी *chūnti* (South Bhagalpur), or चिमन्टा *chimta* (generally), which is the pincers.

568. In Shahabad a famous maker of glass bangle ornaments was one *Samman Churiya*. It is said that when boys he and a king were pupils in the same school, and each promised that on his marriage he would show the other his wife. Samman married first, and did so. When, however, the king married, he refused to carry out the agreement and show his wife to Samman. The latter thereupon disguised himself as a female bangle-maker, and, gaining admission to the female apartments, sold some ornaments to the queen in the presence of the king, who praised the workmanship, saying the bangles were like ivory ones. Next day the king began to boast of his high character, and how *he* would never allow his wife to be seen by an outside man, when he was interrupted by Samman reciting the following verse, which showed the other how he had been made a fool of:—*समन चुरिया ऊ गढ़ेँ षौँ हस्ती के दन्त, बाँह पकड़ि रस लेत हँ, बैठे देखँ कन* *Samman Churiya ū garhen jyoñ hasti ke dant, bānh pakari ras let hain, baithe dekhen kant*,—Samman the bangle-embosser makes bangles like ivory. He held her by the arm, and had the pleasure (of seeing her) while her husband was sitting by.

569. The stamp for making embossed ornaments on the bangle is *साँचा sānchā* (Tirhut and the south-east), *करैली कटना karaili katna* (Champāran), *ठप्पा thappa* (South-West Shahabad), and *चापा chhāpa* (Tirhut and elsewhere in Shahabad). In Champāran and South-West Tirhut *तोगर togar* is an instrument for embossing.

CHAPTER XXVI.—THE LAC BANGLE-MAKER.

570. The lac (*लाक lākh* or *लाह lāh*) bangle-maker is *लहेरी laheri* or *लहेरा lahera*. He uses a block of wood with a handle, on which the bangles are fitted, which is called *कुन्द kund*; a *साँचा sānchā*, which is a brass mould for embossing ornaments; and a *चुभकी chubhki* (and also to the east *चुभन्ती chubhti*), which is an ivory mould for embossing. His bamboo pipe for blowing the fire is *नारी nāri* or *नरि nari*, also *फुकाठी phukāthi* or *लारी lāri* in South Bhagalpur and *फुकाठी phukāthi* in North-East Tirhut.

571. A bangle, whether of glass or lac, is *चुरी chūri*. The latter variety is also called *लहठी lahthi*. Of these the thickest, or keeper, which prevents the thinner ones slipping over the hand, is *कंगनी kangni*. The end bangles of a set are *बन्द band*, or in South Bhagalpur *लरना larna*, and the intermediate ones *सुरकी surki*, and in South Bhagalpur *पण्डा pahta*.

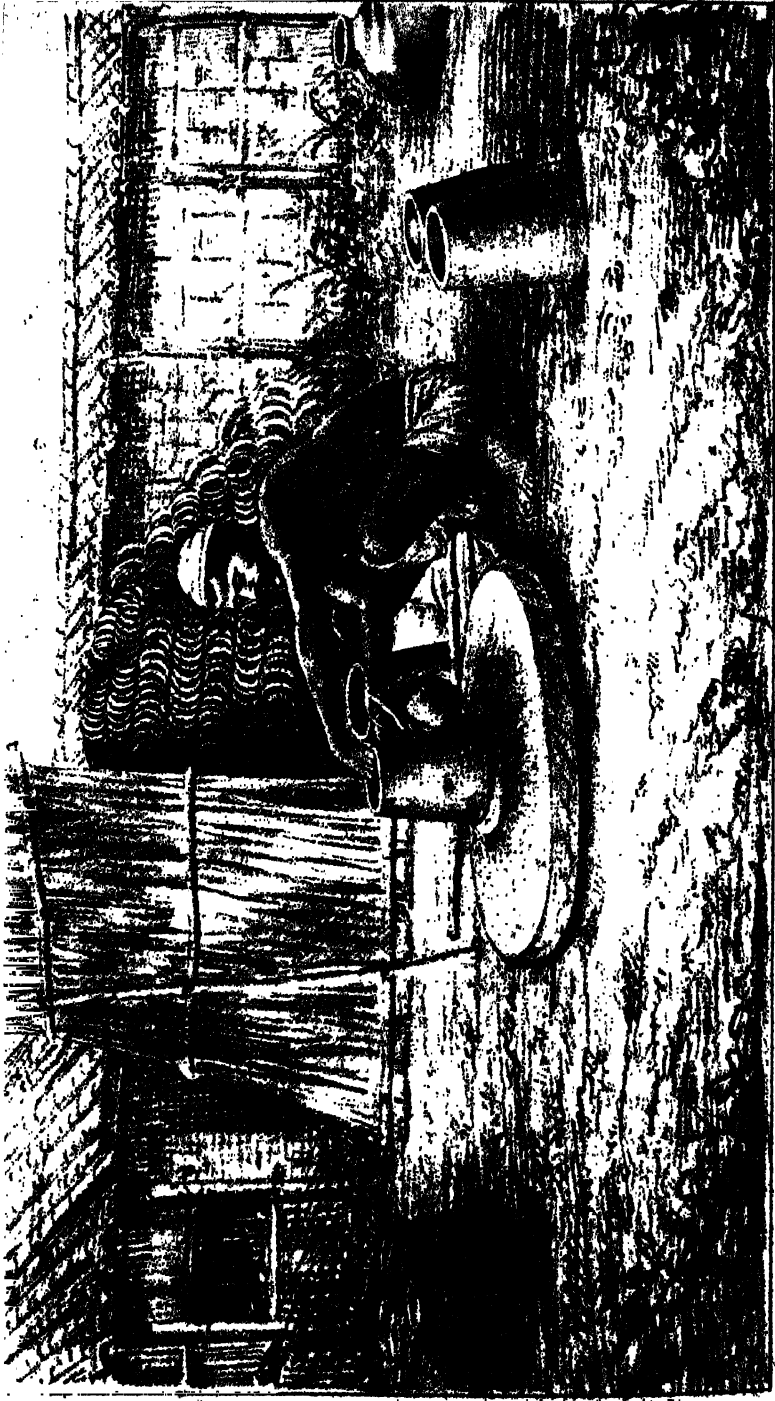

Potter (Kumhar) at work

CHAPTER XXVII.—THE POTTER.

572. The potter is generally called कुम्हार *kumhār* or कुम्हारा *kumhara*; in the east he is also called पण्डित *pandit*, and in Patna and Gaya also परजापत *parjāpat*. In Shahabad he is कुँहार *kunhār*, and in the south-west of the district कोहार *kohār*. Concerning him there is a proverb, निचम सुते कुम्हारा, मटिया नठ ले जाय चोर *nichim sūte kumhara, matiya na le jāy chor*,—the potter sleeps secure, for no one will steal clay. His wife is known as कुम्हैनि *kumhaini* or कुम्हैन *kumhain*, as in the proverb तेली बैल ला कुम्हैनि सति *tehi bail la kumhaini satti*,—for the sake of the oilman's ox, the potter's wife has become *suttee*, i.e., she interests herself in other people's affairs.

573. His *wheel* is चाक *chāk*, which is turned by a stick, चकैठ *chakaith*, or in North-East Tirhut हरि *chhari*, on a peg, which is कीला *kīla* or किला *killa* to the west, and खूँटी *khūnti* or खुट्टी *khutti* to the east. In South Bhagalpur it is, however, सिंहा *silla*.

574. The implement for mixing the clay is लेशुर *lehsur* north of the Ganges and लासुर *lahsur* south of the Ganges generally. In Shahabad it is कटनी *katni*, and in South Bhagalpur पाहा *patta*.

575. The *rammer* for consolidating the clay is पीटन *pītan* when made of wood; when made of earthenware it is पीँड़ *pīnr* north of the Ganges generally and in Shahabad, पिहौर *pirhaur* or पिँदरी *pīnrhuri* in Patna, and पिँदुर *pīnrhur* in Gaya. In South Bhagalpur it is पिनोरी *pīnāri*. The clay is smoothed with an instrument called मिलौना *mīlauna* north of the Ganges and in South Munger, and also मजनी *majni* in South-East Tirhut and South Bhagalpur.

576. The *moulds* for shaping vessels are अथरी *athri* generally. Other names are कठथरी *kathathri* in Patna and करथरी *karthari* in South Bhagalpur. The pots when ready are severed from the wheel by a string called चैवन *chhevan*; also चौनी *chhāuni* in Patna and चैवनी *chhewni* to the east. In South Bhagalpur it is चैवनी *chhevni*. Another name is कमठी *kamthi* in North-West Tirhut. The सचा *sancha* or सँचा *sāncha* is a mould used in making tiles.

577. The *kiln* is आया *āva*.

578. The *clay-pit* has many names, viz. चूषाँ *chūān* (South-West Tirhut), खँहार *khanrār* (Patna), मटिखान *matikhān* (West Tirhut, Gaya, and Shahabad), मठखना *matkhana* (South-West Shahabad and Tirhut), मठखभा *matkhabha* (South Bhagalpur), मठकोर *matkor* (Patna and South

Munger), and मटियार *matiyār* (South-East Tirhut). Other names are कोहङ्गर *kohanrgar* in Sāran and मटखम *matkham* in North-West Tirhut.

579. The earthen pot in which the water which the potter uses while making the vessel is kept is called चकवर *chakwar* in the north-west; also अथवानी *athwāni* in North-West Tirhut, हथवानी *hathwāni* in Gaya and South-East Tirhut, and कदेठ *kadaith* in South Munger. In South Bhagalpur it is चकोड़ी *chakori* or हथपानी *hathpāni*.

CHAPTER XXVIII.—THE FIREWORK-MAKER.

580. The firework-maker is आतसबाज *ātasbāj* or आतसबाज *atashbāj*. In Shahabad and South Bhagalpur he is रवांसवाला *rawāṣwāla*. In South Bhagalpur गोंड़ी *gonri* is the name of a caste whose employment is to make fireworks.

581. He uses a *grindstone*, which is चक्की *chakki* to the west and in South Bhagalpur, and जाँता *jānta* in Tirhut and to the east; also in East Tirhut चकरी *chakri*. In South-West Shahabad it is सिल *sil*.

582. His *ramrod* for ramming the powder is कलबुद् *kalbul* generally, with a variant कलाबूत *kalābūt* in South-West Shahabad. In the rest of Shahabad it is सुम्बा *sumba*, and in South-East Tirhut optionally सुम्हा *sumha* when made of iron. In Sāran it is गज *gaj*. The wooden roller used in making a Roman candle is खोलकड़ा *kholakra*, and in South Bhagalpur also खोलनी *kholni*.

583. His *saw* is आरी *āri*; his *knife*, छुरी *chhūri*. A flat heavy one is बाँकी *bānki* in Sāran and Champāran, बाँक *bānk* in Shahabad, दाब *dāb* in Tirhut, and दबिया *dabiya* also in the north-east of the same district. His *awl* is बरन्ना *barma*, and his *file* is रेतो *reti*.

584. His wooden *platter* is कठरा *kathra* to the west, अथरा *athra* in Tirhut, Gaya, and South-West Shahabad, कठौती *kathauti* or कठौत *kathaut* in Patna, Gaya, and East Tirhut, and कठवार *karhāi* in South Bhagalpur.

585. Among the fireworks which he makes are—

- (a) The hand *Catherine wheel*, चरकी *charkhi*, and that which is mounted on a pole, चक्कर *chakkar*, राधे चक्कर *rādhe chakkar* (South-East Tirhut), or चकरबाज *chakarbān* (Shahabad).

Of these, the pipes in which the powder is placed are **नाल** *nāl*, or to the east **लाल** *lāl* or **लाला** *lāla*, and in South Munger **नाला** *nalla*. The pipe in which the axle works is also called **नाल** *nāl*, &c., as above; also **पुष्पी** *pulli* in South-West Shahabad, **कुलूपी** *kulphi* in South Bhagalpur, and in South-East Tirhut **दनियाली** *daniyāli*. The axle itself is **मकरी** *makri* or **कुचुकी** *chhuchhki* north of the Ganges generally, and also **फोंफी** *phonphi* to the west. The spokes and rim of the wheel are **ढाँचा** *dhāncha* to the west or **धन्चरी** *dhanchri* in Sāran, **उट** *thāt* in Tirhut, **मड़री** *marri* in South Munger, and **मँडुरा** *menrra* in South Bhagalpur.

- (b) There are various kinds of *bombs*: amongst them are **सुचम्पा** *bhuchampa* or **सुचम्पा** *bhuchappa* (north of the Ganges) or **सुहँ चम्पा** *bhuin champa* (south of it), **अनार** *anār* (generally), **कुलिहिया** *kulhiya* (north of the Ganges) or **लौकी** *lauki* (east generally), **बमगोला** *bamgola* (generally) or **गोला** *gola* (Champāran and North-East Tirhut), **तड़ाका** *turāka* (south of the Ganges), **नास पाल** *nās pāl* (generally), **दाँतुषा** *dāntua* and **तोरन्ना** *torna* (Shahabad). A long kind of bomb is north of the Ganges **चहका** *chahka*.
- (c) The *balloon* is **पेटारा** *petāra* south of the Ganges, and **पेटाहा** *petārha* or **गोबारा** *gobāra* north of the Ganges, to the west. In North-East Tirhut it is **उरन्ता पेटाहा** *urtā petārha*, and in South-East Tirhut **उरन पेटाहा** *uran petārha*.
- (d) The *rocket* is **हवाई** *hawāi* or **असन्मान तारा** *asmān tāra*; also **खड़ी** *chhari* in North-West Tirhut. In South-West Shahabad, Sāran, and Champāran **बान** *bān*, and in North-East Tirhut **जङ्गी बान** *jangi bān*, is a species of rocket.
- (e) The *Roman candle* is **महन्ताबी** *mahtābi* generally, also **दस्ती** *dasti* north of the Ganges and **गल्लर** *gallar* in Shahabad and East Tirhut.
- (f) *Other fireworks* are **महन्ताब** *mahtāb*, **खजूर** *khajūr*, **किला** *kilā* (a miniature fort, of which the bastions are **बुरन्जी** *burji*), **गञ्ज सितारा** *ganj sitāra*, **कदम गाह** *kadam gāchh*, **चादर पड़ाकेदार** *chādar parākedār*, **सादा चादर** *sāda chādar*, **चादर** *chādar* or (East Tirhut) **सासन के टट्टी** *sausan ke tatti*, **चाँद चरन्धी** *chānd charkhi*, **पटेबाज** *patebāj*, **किरिन** *kirin* or

(North-East Tirhut) किरिन चक्कर *kirin chakkar*, कुकुन्दर *chhuchhundar* (West Tirhut and South-West Shahabad), जलेबी *jalebi* (South-West Shahabad), मुरुरा *murra* or मुरुरा चा *murra* (South-West Shahabad and Gaya), चन्दर कला *chandard kala* (South West Shahabad), पड़का *parāka* or (South-West Shahabad) पटाखा *patākha* (Chinese crackers), मूड़ा *mūrha*, दीपक *dīpak*, जूही *jūhi*, रसंपाल *raspāl* (Sāran and Champāran), अरदाना *ardāna* (East Tirhut), देव *deb* or देव *deo* (a flying monster), नटबाज *nathāj* or लरत देव *larat deb* (fighting monsters), कैत बान *kait bān* (a round rocket), फारसी गोला *phārsī gola*, टट्टी लीलू फर *tatti līlu phar* (south of the Ganges), घन चक्कर *ghan chakkar* (south of the Ganges), मोर चक्कर *mor chakkar* (south of the Ganges), मोर बाज *mor bāj* (south of the Ganges), पंचरखी *pancharkhi* (Shahabad), चौताना *chautāna* (Shahabad), हजार बौन *hajār bin* (Shahabad), चौघड़ा *chaughara* (Shahabad), हुलुक *huluk* (Shahabad), and बतसा *butāsa* (Patna), which is also called अंगारी *angāri* in Shahabad. In South Bhagalpur लौकी *lauki* and पडुका *paduka* have been noted.

CHAPTER XXIX.—THE BOOKBINDER.

586. The bookbinder is in North-West Bihār दफन्दरी *daphdari*, and in East Tirhut दफतरी *daphtari*. In South-East Tirhut he is also called कागजी *kāgji*. South of the Ganges he is जिलदबन्द *jildband*, or in Shahabad जिलदगर *jildgar*.

587. His screw-press is सिकका *sikanja*. Another kind of press is मकरी *makri*. The wooden boards for putting between the books in the screwpress are लखना *takhta* or (in Patna and South Bhagalpur) लखनी *takhti*. In Shahabad and North-East Tirhut they are पटरी *patri*; in South-East Tirhut, पिदिहा *pirhiya*; and in South-East and North-West Tirhut, निष्करदा *nishkarda*.

588. The paper-cutter is कतरनी *katarni*, or (in Champāran) पाढ़ *pārḥ* or बाढ़ *bārḥ*. The scissors are कैची *kainchi*, or in North Bihār also मेकराज *mekrāj*.

589. The iron mallet is हथौरी *hathauri* or मारतौल *mārtaul*, and the awl सूआ *sūa* north of the Ganges generally and in Shahabad and South Bhagalpur, सुराखी *surākhi* in Patna, सुलाखी *sulākhi* in Gaya,



A Native Rope Walk.

री *sutāri* north of the Ganges, and टेकुषा *tekua* optionally in South-
Tirhut. The *needle* is सूरे *sūē*.

590. The *embossing-wheel*, which is an instrument with a small
living wheel for embossing the binding, is फिरकी *phirki* in
North-West Bihār and South-East Tirhut, चक्की *chakki* in Tirhut
Patna, चक्कर *chakkar* in Gaya and South Bhagalpur, and
चक्का *chakka* in Shahabad. Other dies for embossing are फूल *phul*
(optionally in Champāran and Tirhut) ठप्पा *thappa*; also झालर *jhālar*,
जौरा *janjira*, and दोसूती *dosūti*.

591. The *cutter* for paring edges is झामा *jhāma* north of the
Ganges and Patna, and सोहन *sohan* elsewhere. A file for the same
purpose is रेतौ *retī*.

592. The wooden *tool for smoothing the binding* is सलेस *sales*
(corruption of English 'slice'). It is also called तिल्ली *tilli* or तीली *tīli*,
and in East Tirhut कमची *kamchī*.

593. The *leather-scraper* is खुरपी *khurpi*, also north of the
Ganges चिल्लीनी *chhīlīnī*. पत्थर *patthar* is the flat stone on which the
leather is scraped.

CHAPTER XXX.—THE ROPE-TWISTER.

594. The rope-twister is कज्जर *kanjar* in North-West Bihār and
Gaya, and चाँद *chāin* in West Tirhut. In Shahabad and Gaya he is
रबन्दा *rasbanta*. The art of rope-twisting is बटनार *batnāi*.

595. His rope-twisting implement is called घिरनी *ghirni* or घिरनी
īnāi, also घड़ी *ghari* in South-West Tirhut. Of this the भौरकली
aunrkali is a flat stone with a hook, to which the rope is fastened as
it is being twisted; sometimes a peg, खूँटी *khūnti*, is used for this purpose.
The board or bamboo fixed in the ground and perforated with holes, by
which the strands, लार *lar*, pass is called गड़ाड़ी *garāri* north of the
Ganges, गरारी *garāri* in Patna, घररी *gharri* in Gaya, and घिरनी *ghirni* in
Shahabad. The strands are fixed to the ends of pegs, बेलन *belan*, which
revolve in these holes.

596. The string used to move the machine is घिरना *ghirna*.

597. When cables and thick ropes are made, an instrument called
(north of the Ganges) हत्था चरक *hatthā charak* and (south of the Ganges)
मूथा *mūtha* is used. This is a grooved block, in the grooves of which
the strands are fixed to secure uniformity in the twisting. A man holds
it in his hands, and carries it forward as the strands are twisted.

598. A simpler kind of machine is called चरख *charakh* or चरन्ही *charkhi*. It consists of only a bent wooden handle, डण्डी *dandi*, and a perforated board. The strands are fastened at one end to the handle, and the other ends are twisted by hand.

CHAPTER XXXI.—THE WEAVER'S BRUSH-MAKER.

599. The weaver's brush-maker is called कुँचबन्धवा *kunchbandhwa*. The brush is called कुँची *kunchi*, कुँच *kunch*, &c. (See Chapter on Weaving.)

600. He uses the साँचा *sāncha*, which are two moulds for keeping the brush in order while it is being prepared. He beats the brush with a ठोकना *thokna*; and he has a flat piece of wood called पटरी *patri* for keeping the bristles in order.

CHAPTER XXXII.—THE BOW-MAKER.

601. A bow is कामान *kamān*, or in North-East Tirhut कामठा *kamtha*, and its maker is कामनगर *kamangar*. He has no special implements.

CHAPTER XXXIII.—THE WEAPON-CLEANER.

602. The सिक्किनगर *sikilgar* or arms-cleaner uses a रन्दा *randu*, or in North-East Tirhut जाम *jhām*, which is a kind of plane for cleaning off rust; a गुल्ली *gulli*, a piece of hard stone for a similar purpose; कुरन *kurun*, a kind of stone powder. He also uses a सिंघौटा *singhautu* or polishing-horn, a मसकली *maskali* or iron instrument, and गद्दी *gaddi* or thick cloth, both used for varnishing.

DIVISION II.

DOMESTIC APPLIANCES AND UTENSILS.

SUBDIVISION I.

APPLIANCES USED IN THE PREPARATION OF FOOD.

CHAPTER I.—SIEVES.

603. The winnowing-sieve is *सूप* *sūp* or *कोलसूप* *kolsūp*. The latter is also used for sifting grains of various sizes. It is made of bamboo. The former is used for winnowing only, and is woven of bamboo. They are both oblong in shape, and have a low wall round the sides, called in East Tirhut *मड़रा* *marra*. Other names are *कोनिया* *konīya* (North-East Tirhut) and *डगरा* *dayra* (see § 47) in Gaya, Champāran, and North-West Tirhut.

604. The *चालनी* *chalni*, or (North-East Tirhut) *चालनि* *chālani*, is a woven sieve for sifting bran from flour, as in the proverb concerning an extravagant man, *कोन पुरुषक भेलऊँ गाय, चालनि ले दुहावे जाय* *kon akhak bhelāhuñ gāy, chālani lai duhāve jāy*,—of what man have I come the cow: he has brought a sieve into which to milk me. In Bihar, *चालनि ठूसल रूप केँ, जनिका सहसर गोट ह्वे* *chālani tūsal sūp keñ, ka sahasar got chhed*,—the sieve, which had a thousand holes, used at the winnowing-basket, *i.e.* the pot called the kettle black.

605. The *चिलवन* *chilvan*, or in Sāran, Patna, and Gaya *चिलौज* *chilauj* or *चिलौद* *chilaund*, and in South Munger *चिलौन* *chilaun*, is a kind of sieve used for catching fish, and also (according to Crooke) in the North-Western Provinces for straining sugar-cane juice. Other names are *आरसी* *ārsi* or *जङ्घा* *jangha*, both used in South Bhagalpur, the latter in North-East Tirhut and the former in Sāran.

606. The *चालना* *chalna* is a sieve for cleaning grain. Other names are *झरना* *jharna* south of the Ganges, *तरछी* *tarchhi* in Champāran and *गुरचालना* *gurchalna* (North-East Tirhut).

607. The *आँगी* *āngi* or *आँगिया* *āngiya* is a cloth-bottomed sieve for sifting fine flour. It is called *हॉगी* *hāngi* in Gaya and *कपरघूर*

kapardhūr optionally north of the Ganges. In Azamgarh, in the North-Western Provinces, चाँची *āngī* is a leather sieve with very fine holes.

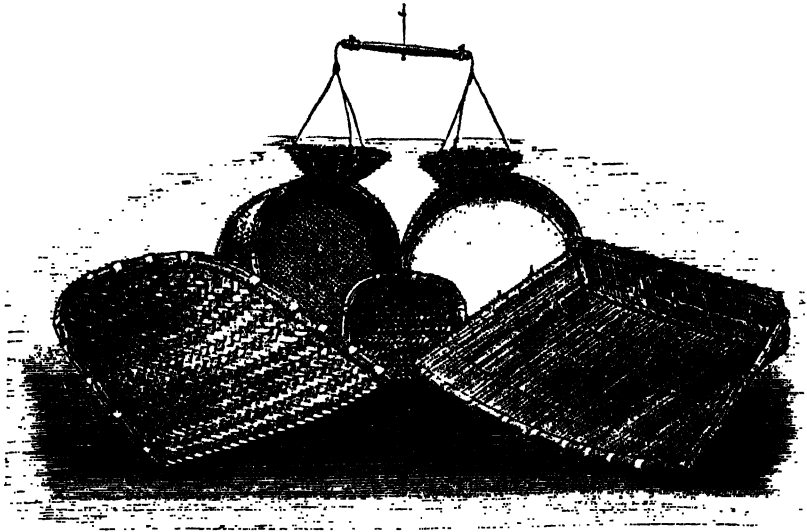

	Tarāju.	
Chalni.	Supuli.	Āngī.
Kolsūp.	—	Sūp.

CHAPTER II.—THE PEDAL FOR HUSKING GRAIN.

608. The whole apparatus, and also the movable *beam*, is called दूँकी *dhenki* or (in Shahabad) देँका *dhenka* or देका *dheka* and (in Saran) देँकुल *dhenkul*.

609. The *pillars* on which the beam rests are जङ्घा *jangha* in North and East Biḥār, जाँघा *jāngha* in Shahabad, and जँघिया *janghiya* in North-West Tirhut. In Tirhut and the west they are खूँटा *khūnta*, in Patna and Gaya खुँटा *khunta*, and in South Bhagalpur and South Munger खुँटा *khutta*. In South-West Shahabad they are called खम्भा *khambha*.

610. The *peg* in the beam which crushes the rice is मूसर *mūsar* to the south and west, and मुसरा *musra* in Tirhut, Patna, Shahabad, and South Bhagalpur. In Saran another name is पहरा *pahara*. In South Munger, Patna, and Gaya it is समठ *samāth* or समँठ *samānth*, and समौचा *samaua* is the iron ferule round its tip.

611. The *axle* is generally अखौत *akhaut* or अखौता *akhauta*, local names being मँजा *mānjha* in Champāran and North-East Tirhut, बेलनी *belni* in North-West Tirhut, and डण्डा *danda* also in North-East Tirhut. In Patna it is रनकी *ranki*, in South Bhagalpur अस्कलार *askalāi*, and in South-West Shahabad सारा *sāra*.

612. The *hollow wooden bed* in which the rice is crushed is ओखरी *okhri* north of the Ganges, or as a local variant ओखर *okhar* in North-East Tirhut and the north-west. ओखरी *okhri* and सुन्दो *bhundo* occur also in South Bhagalpur, and अखरी *akhri* in South Munger. In South-West Shahabad it is काँड़ी *kāuri*, in the rest of the district भुरिया *bhuriya*, in Gaya सुँओखरी *bhuiñokhri*, and in Patna भुँडकी *bhunrki* or घुण्डी *ghundi*. The stick used for stirring the grain while it is being pounded is in Gaya and South Bhagalpur ठेकरा *thekra*.

613. The *hand-rail* which the workman grasps is अस्थम *astham* north of the Ganges and थमनी *thamni* or अलगनी *algani* in South Bhagalpur. It is टँगनी *tangni* in Patna and South Munger, also अड़ानी *arāni* in South Munger, and हथी *hatthi* in Gaya. In Shahabad a rope (रस्सी *rassi*) is used.

614. The *pedal* or place where the worker rests his foot is पौदर *paudar* in Patna and Shahabad, पक्कर *pachhahar* or पकाड़ *pachhār* in Sāran and Champāran, पुक्करा *puchhra* in North-East Tirhut, पकौरा *pachhaura* in South-West Shahabad, पकुआ *pachhua* in South Munger, पुक्किया *puchhiya* in South Bhagalpur, पौंही *ponchhi* in Gaya, and लतमरा *latmara* in North-West Tirhut. The pit into which this is depressed is in Gaya गोरपौरी *gorpauri*, and in South Bhagalpur गतो *gatto*.

615. This implement is practically the same as the lever for breaking bricks, for an illustration of which see § 431.

CHAPTER III.—THE PESTLE AND MORTAR USED FOR HUSKING GRAIN.

616. The *mortar* is ओखरी *okhri* generally, local variants being ओखर *okhar* in North-East Tirhut and Shahabad, ओखरा *okhra* in South-West Shahabad, and ओखली *okhli* in Gaya. In Patna an optional name is कुरन्दन *kurdan*, and in Sāran धनकुट्टी *dhankutti*.

617. The *pestle* is मूसर *mūsar* to the west and समाठ *samāth* to the east. In Patna both words are used.

618. The iron *ferule* at the bottom of the pestle to prevent it splitting is *साम sam*, or in Patna, Gaya, and the south-east *समीचा samaua*, and in Saran optionally *समियाँ samiyāñ*.

CHAPTER IV.—THE HAND GRINDING-MILL.

619. This is known as *जाँत jānt*, *जाँतवा jantwa*, or *जाँता jānta*. This is worked by two women. The smaller kind, used for breaking pulses and worked by one person, is *चकरी chakri* generally, or *चकी chakki* to the west. North of the Ganges *चकुला chakula* is a medium-sized one.

620. The *upper stone* is *उपरौटा uprauta*, and the *lower stone* *तरौटा tarauta*, and also south of the Ganges *तलौटा talauta*.

621. The *handle* of the large variety is *हाथड़ hāthar* in South-East Tirhut, and elsewhere *थयग्रा* or *थयगड़ा hathra*. In Shahabad it is *जूषा jā*. That of the smaller variety is *खूँटी khūñṭi*. The *axle* is *किला killa* or (in South-East Tirhut) *कील kil*; and the *feeding channel*, *मुँच munh* generally; also *गाली gālī* in Shahabad, Gaya, and South Bhagalpur, *गल्ली gullī* in Saran and North-East Tirhut, *गलौसी galāusi* in Champāran, *खौरख khoñichh* or *गलियारी galiyāri* in North-West Tirhut, *गत्तो gatto* in South Bhagalpur, and *घड़िया ghariya* in South-West Tirhut.

622. The *handful of grain* poured into the mill is *भौँक bhūñk*, local variants being *भौँका bhūñka* in Saran, Patna, and South-East Tirhut, and *भौँका bhūñka* in South-East Bihar. In South Bhagalpur it is also *लपो lappo*.

623. The *wooden seat* on which the woman sits is *पीड़ा pīṛha*. A local variant is *पीड़ी pīṛhi* or (East) *पिड़िया pīṛhiya*. A similar mud seat is *बैसनी bāisni*, or in Champāran *बैठनी baithni*, and in South-East Tirhut *बैसन bāisan*. In South Munger it is *बैसका bāiska*, and in South Bhagalpur *बैसको bāisko*.

624. To roughen the stone with a chisel is north of the Ganges *टाँगव tāngab* or *टूँगव tūngab* to the west and *कूटव kūṭab* to the east. South of the Ganges, to the west, it is *कूटल जारव kūṭal jārb*, and to the east *कूटाग्रव kūṭāḡrab* or *कूटिदेव kūṭideb*. The man who does this is called *जतकुटा jantkutta*. He uses a chisel, *चेनी chheni*, and a hammer, *थपुआ thapua* or *थपौरी hathāuri*.

625. The act or profession of grinding corn is *पिसान pisān*, *पिसव्यन pisवान*, or in Champāran *पिसना pisna*, and in Gaya *पिसार pisār*,



MILL-STONE FOR PESTLE AND MORTAR FLOUR-MILL
PULSES (Chakri) (Okhri) (Jant)

Litho by Harn. Chandra. Ghosal, Student, Govt. School of Art, Calcutta

Printed by P. D. Das, Nehru Govt. School of Art, Calcutta

and its wages पिषार *pisāi*. A well-known proverb is जाइसी पटना जोड़ा एक जाँत, *jāichhi patna jora ek jānt*,—‘I go to Patna for a pair of mill-stones,’ something like a Newcastle-man going to London to look for coals.

CHAPTER V.—THE GRINDSTONE FOR SPICES.

626. This is सिलानव *silcat* or सिलौट *silaut*, and in Saran सिलावट *silāvat*; also in Patna, Gaya, and South-East Tirhut सील *sīl*. To the south-east it is also पाटी *pāti*.

627. The *stone roller* used with it is लोहा *lorha* to the west and लोही *lorhi* to the east. In Patna another name is बहा *batta*.

CHAPTER VI.—THE ROLLER FOR MAKING PASTE.

628. The *rolling-pin* is बेलना *belna*; also बेलन *belan* in Patna.

629. The *pasteboard* is चौकी *chauki* to the west and चकला *chakla* to the east. In South-East Tirhut another name is चकोला *chakola*, in Gaya चौकला *chaukla*, and in North-East Tirhut चक *chak* or चाक *chāk*.

630. The dry flour sprinkled on the board to prevent the paste sticking is परगन *parthan* generally, with local variants परगनी *parthani* to the west and पलेथन *palethan* in Patna and South Munger. In South-East Tirhut it is optionally called माड़ा *māra*.

SUBDIVISION II.

DOMESTIC FURNITURE.

CHAPTER I.—STOOLS.

631. Stools made of bamboo or reeds are मोड़ा *monrha* when large, and मोदिहा *monrhiya* when small.

632. When made with a woven twine seat, a wooden framework, and four legs, they are called मचिहा *machiya*. Another name is मचोला *machola*, current in Champāran.

633. When it has three legs, it is called तिपार *tipāi* north of the Ganges, and तेषार *tepāi* or तेषर *tepai* south of it. In Shahabad a three-legged stool is called मेच *mench*.

634. A wooden stool is, according to size, चौड़ा *pirha* (large), पीढ़ी *pirhi* or पिढ़ि *pirhi* (smaller), and पिढ़िया *pirhiya* (smallest).

635. The wooden platform for sitting, sleeping, or bathing is, when large, तखतपोष *takhatpos*, and when small पट्टरा *patra*. चौकी *chauki* is used for both large and small kinds.

CHAPTER II.—THE BED AND COT.

636. A *bed* or *cot* is खाट *khāt*, खटिया *khatiya*, or पलङ्ग *palang*. When an ordinary bed, it is specially called चारंग्पा *chārpāi* or चरंग्पा *charpāi*, and when a cot, खटोला *khatola* or खटोली *khatoli*; also in South-East Tirhut खटुला *khatula*. Another name is पलंगिया *palangiya* or पलंगरी *palangri* in Shahabad and South Munger; another name is सजेसा *sajesa* or सेजिया *sejiya*, which is used principally in poetry.

637. The *pillow* is तकिया *takiya* or तकेसा *takea*, also गेरसा *gerua* in East Tirhut and सिहानी or सिहानी *sirhāni* in Tirhut and the west. The *bolster* is बासीस *bāsis*, बलिहा *balista*, or (in South-West Shahabad) बिलहा *bilasta*. The side bolsters are बगली तकिया *bagli takiya*, and the heavy thick bolster for resting the back against is मसनद *masnad* or गौ तकिया *gau takiya*. The *bed clothes* are बिहाखोन *bichhāon*, बिहौना *bichhauna*, or गेटम *getam*. The *mattress* or its equivalent is तोसक *tosak*. In Tirhut ओहाखोन *ochhāön* or ओहौना *ochhauna* are the bed clothes over the body. A patchwork quilt, &c., worn by the poorer orders is गेंदड़ा *gendra*, (also in Champaran and to the east) खेंदड़ा *khendhra*, or सोजनी *sojni* in South Bhagalpur, Patna, and Gaya, खेंदरा *khendra* or सुजनी *sujni* in Saran and West Tirhut, लेंदरा *lendra* in Shahabad, and गुदड़ा *gudra* or लेवा *lewa* to the west generally. In South Bhagalpur it is भोथरा *bhothra*. See also § 731.

638. The *legs* of the bed are पौसा *paua*, पाया *pāya*, or पावा *pāva*. The side pieces are पाटी *pāti* or पट्टी *pattī* generally, also पासी *pāsi* in Tirhut and South Bhagalpur. The end pieces are चूर *chūr* or चूल *chūl*. The head of the bed is सिहाना *sirhāna* or सिहानी *sirhāni* north of the Ganges, also मुरथारी *murthāri* in North Tirhut and सिरमा *sirma* in North-East Tirhut. South of the Ganges it is सिरहाना *sirhāna* (Shahabad also सिरहान *sirhān*) or मुरथारी *murthāri*, also सिरवाँसी *sirwānsi* in South Bhagalpur. The foot of the bed is गोरथारी *gorthāri* or गोरथरिया *gorthariya*. In Shahabad it is गोटार *gortār*, and in Saran गुन्थारी *gunthāri*; also गोटारी *gotāri* north of the Ganges generally and in South-West Shahabad, पथौनी *pathauni* in South-East

पथाना *pathāna* in North-East Tirhut. South of the Ganges we find optionally पैताना *patāna* in Shahabad and Patna, पौताना *pautāna* (also in South Munger) or पोथानी *pothāni* in Gaya, and पौथाना *pauthāna* in South Munger.

639. The *network* at the bottom is विनावट *bināwat* or विनाद *bināi*, or in East Tirhut घोरार *ghorāi*. In Patna and Gaya it is बीनन *bīnan* or विनौट *binaut*, in Shahabad विनाव *bināw*, and घोरन *ghoran* in South Bhagalpur and South Munger. When this is made of one string, the bed is said to be एकबधिया *ekbadhiya*; of two strings, दोबधिया *dobadhiya*; of four strings, चौबधिया *chaubadhiya* (west); and of six strings, छबधिया *chhabadhiya*. In South Bhagalpur the words एकगोटिया *ekgotiya*, दुगोटिया *dugotiya*, चरगोटिया *chargotiya*, and छगोटिया *chhagotiya* are used. In South Munger they are एकजोरिया *ekjoriya*, &c. The strings at the bottom by which the netting can be tightened at pleasure are ओरन्चन *orchan* or ओरन्द्वानी *ordawāni* in Tirhut and the west. In Sāran and Patna they are ओरन्चन *orchan* or ओद्वारन *odwān*. In the east they are अरँच *arānch*. Other local names are ओनन्चन *onchan* in South-West Shahabad, ओदारन *odān* in Gaya, अद्वारन *ardwān* to the east, ओदान *odān* in South Munger, and बाध *bād* or गतान *gatān* in North-East Tirhut. The thick rope at the foot to which the netting is tied is सिध्वानी *sidhwāni* in the north-west; also मँही *māhi* in Champāran. In South-East Tirhut it is अजन्वारन *ajwān*. In Patna it is मारँ *mān*, in Gaya मेथार *meār*, in South Munger मारन *mān*, and in South Bhagalpur बान *bān* or मैन *main*. Elsewhere it is also called ओरन्द्वानी *ordawāni*. The string tied to the side as the netting is being made is बरुआ *barua* in the north-west and south. In Tirhut and the east generally it is ओजा *ojha*, or in South Bhagalpur also जमौआ *jamaua*. When the netting is finished this string becomes useless, and villagers believe that if it be thrown across the door of a house the members of that house will quarrel amongst themselves. The सोग *soy* or सोक *sok* are the large spaces in the netting along the frame of the bed.

CHAPTER III.—THE WEIGHING-SCALES.

640. The *large fixed scales* are रातल *rātal*, local variants being रातुल *rātul* in Shahabad and रातन *rātan* in North-East Tirhut. In South Bhagalpur they are काँटा *kānta*, which elsewhere means the small scales. Another name in the same place is मन्काँटा *mankānta*. The small scales are तराजू *tarāju*, local variants being तरजू *tarjū*

in the north-west, तरजू *tarju* in East Tirhut and South Munger, and तरजूषा *tarjūa* in South Bhagalpur. Other names are काँटा *kānta* and टकौरी *takauri* in the west and Patna and Gaya, and परिधानी *pariyāni* in Patna and Gaya, which principally refer to goldsmith's scales. In South Bhagalpur तूल *tūl* is a weaver's scale for weighing thread or cotton.

641. The *pans* of the scale are पखरा or (in Patna and Gaya) पखड़ा *pakha*. In South Bhagalpur they are also called डलनी *dalni* or पला *pulla*.

642. The *strings* of the scale are called तन्नी *tanni* (except in the east), a local variant being तानी *tāni* in Gaya. In the east they are जोती *joti* or (in South Munger) जोता *jota*. In Patna optional names are डोरी *dori* and बाधा *bādha*.

643. The *weights* are बटखरा *batkhara* or बाट *bāt*. The *make-weight* put into one scale to make the balance true is पसंगा *pasangha*, local variants being (East Tirhut) पासंघ *pāsangh* and (Patna, Gaya, and South Bhagalpur) पसंगा *pasanga*. In Patna and Gaya and South Munger it is also called धारा *dhāra*.

644. The *beam* of the scales is दंडी *dandi*. In the south-east the beam of a jeweller's scale is नित्ती *nitti* or नित्ती *nikti*. The *indicator* is सूर *sūi*.

645. A *false balance* is नेवत *newat* or नेवता *newta* to the west and in Gaya. In East Tirhut it is लेवत *lewat*, and in Champāran नवता *navta*. In South-West Shahabad it is जीयत *jiyat* or जीता *jita*, and so also in Gaya and South Munger. In Patna and Gaya it is झुकता *jhukta*, and in South Bhagalpur जोती *joti*.

CHAPTER IV.—NETS.

646. A small fisherman's net is जाळ *jāl* or जाळी *jālī*, and a महाजाळ *mahājāl* is one of a larger size. North of the Ganges and in Shahabad a कुरैल *kurail* is a net fixed in the water with six sticks and worked by one man. In South Bhagalpur it is खरैल *kharail*. A similar net with three sticks is बिसारी *bisāri* north of the Ganges and in South Munger; also बिसरी *bisri* in Champāran, and बिसार *bisār* in Champāran, Gaya, and South-East Tirhut. In North-East Tirhut, however, it is called खनसारी *khansāri*, and in South Bhagalpur चौंधा *chaundha*. A casting-net is फेंकैल *phekail* in Patna, Gaya, and Saran, खेप *khep* to the west, and घुमाँचा जाळ *ghumaua jāl* in Tirhut and South Munger; also

in North-East Tirhut बडियार *khapiyār*. In South Bhagalpur it is फेका *pheka*. The iron or earthen sink-balls attached to it are बडिवन *bativan* and बडवन *batwan* to the west, and पौड़ी *pauri* in North-West Tirhut. In South Bhagalpur they are भौटिया *bhontiya*. A net attached to two poles and worked by two fishermen is डौड़ी *donri* in Patna, Gaya, and the west, and डौड़ *donr* in Champāran. Other fishing-nets are घनैली *ghanaili* and पसर *pasra* to the west, and गिरगिरा *girgira*, a small variety, used in Gaya and the south-east. In the same district and in Champāran ओका *oka* is a bag dragged through the water for catching fish. In Champāran and North-East Tirhut टापू *tāpi*, in Shahabad टाप *tāp*, and in South Bhagalpur अरन्सी *arsi*, is a kind of bamboo fish-net, and गौज *gānj* or गौजी *gānji* is a horn-shaped basket for catching fish. The man who works the last is called गजवाह *gajwāh*. In this connection may be mentioned a fish-trap used in Gaya called चिलौंद *chilaund* (see, however, § 605). Fish caught in this are kept in a pit, called आपा *āpa*. A kind of pit used for catching fish is called in Gaya फरका *pharka*. A net for catching birds is घनी *ghani* north of the Ganges; also फान *phān* or फानी *phāni* in Champāran and Tirhut, and फाँदा *phānda* in Shahabad. South of the Ganges the बडियारी *baliyāri* is a net used in the daytime, and चतर *chātar* one used at night for catching birds.

647. North of the Ganges the ओला *jhola* or ओली *jholi* is a net used by cartmen for feeding bullocks. To the west it is ओरी *jhori*, and elsewhere south of the Ganges जला *jalla*. जाला *jāla* is a net for carrying grass. A local variant is जला *jalla* in Sāran and South Munger. In South Bhagalpur it is कपार *kapāi*.

648. To the west (including Patna and Gaya), and in Tirhut, सिकार *sikhar* is a net for hanging up pots, &c., in a house. Other names are सौका *sinka* (Patna and Gaya), सीका *sika* (Sāran, Champāran, and the east generally), and सीक *sik* also in North-West and South-East Tirhut. खौजी *khāuji* in North-East Tirhut is a net for holding fruit.

649. The stick or rope for hanging up clothes is अरगनी *argeni* in Sāran, Champāran, Patna, and North-East Tirhut, अरगनी *argani* in Shahabad and Tirhut, अरगनी *asgani* in Tirhut (optionally), Shahabad, Patna, and Gaya, and रेगनी *regni* in Shahabad. Other names are टंगना *tangna* in Patna, Gaya, and South Munger, टंगनी *tangni* or दौनी *dauni* in Patna and South Bhagalpur, and जियता *jiyata* in

Shahabad. A frame used for the same purpose is डडरी *thatri* to the west and चडरी *chhatri* in North-West Tirhut.

650. A cord net for carrying goods on the head is जखखरी *jalkhari* in West Tirhut and to the north-west, and जाली *jāli* in Shahabad, South Munger, and Tirhut. In the south-east it is जाला *jalla*.

651. The net used by bearers with the sling pole (बहंगी *bahangi* or, in North-East Tirhut, बहिंगा *bahinga*) is generally सिकखर *sikhar*, but सीका *sika* in the south-east, सिक्का *sikka* in Gaya, and सीक *sik* (optionally) in North-West and South-East Tirhut.

CHAPTER V.—THE PAD USED FOR SUPPORTING WATER-POTS &c., ON A WOMAN'S HEAD.

652. This is बिडा *bittha*, बीडा *bitha*, or बीडो *bittho* to the west and in West Tirhut. In Patna, Gaya, and the south-east it is नेडो *netho* or नेडुचा *nethua*. Another name is गेंडुचा *genrua* to the west and in Gaya and South Munger, गेंडुली *genruli* in Patna and Gaya, and गेंडुड़ी *genruri* in Tirhut. Another name (only noted north of the Ganges) is बिंरिया *binriya* in Champāran, बिंररी *binrri* (a small kind) in Sāran, बीरो *binro* in East Tirhut, and बिंरुचा *binrua* in Tirhut generally; yet another name is लजुरी *lajuri* in South-West Shahabad.

CHAPTER VI.—THE STICK.

653. The ordinary long stick is लाठी *lāthi* (also लठ *lath* in Patna). Other names are लौर *laur* (north of the Ganges) or लाउर *lāur* to the west, and सडका *satka* north of the Ganges. The butt end of this is हूरा *hūra* north of the Ganges and in Patna, डरुरा *hurra* in Shahabad and the south-east, हुत्ता *huttha* in Gaya, and गोचा *goa* in South Munger optionally.

654. सोंटा *sonta* or सोटा *sota* is a stout short stick. It is also called डखा *danta*, and in Champāran डडौका *datauka*. A thin stick is चडी *chhari*, and to the west, including Patna and Gaya, गोजी *goji*. Other names are खकन *chhakan* in Champāran and North-West Tirhut and चकनी *chhakni* in South Bhagalpur. A thick walking-stick is दँग *dāng*, and also, to the west, लबदा *labda*, and a similar one, used principally by old or lame men, is ठेंगुनी *thenghuni*. This last is also called ठेंगुरी *thegunri* in Champāran and West Tirhut, ठेंग *theng* or ठेंगुनी *thenguni* in Shahabad, and ठेंगा *thenga* in the south-west of the

same district. In South Bhagalpur it is ठेंगनी *thengni*, and elsewhere ठेंगी *thengi*. बेसाखी *besākhi* is a crutch. In Shahabad पटकन *patkan* is a walking-stick. A piece of split bamboo used as a stick is फट्टा *phattha*, फट्टी *phatthi*, or फराठी *pharāthi*. It is also called बँसफट्टा *bansphatta* or बँसफँटा *bansphenta* in Patna and Gaya, and बत्ती *batti* in the south-east. A heavy stick is बोंग *bong*, or to the north-west बजर बोंग *bajar bong*.

655. The following Hindi lines in praise of the stick are very popular in Shahabad, a district famous for its club-men :—

लाठी ऐसी चीज है सदा रखिये सङ्ग ।
 नदी नार अगाह जल तहाँ बचाओ अङ्ग ॥
 तहाँ बचाओ अङ्ग भपट कुत्तो को नार ।
 दुरजन दावागीर उस को मसक भार ॥
 कह गिरधर कवि राय लिख भेजिये पातौ ।
 कमर लिये तरवार हाथ में लिये लाठी ॥

*Lāthi aisi chij hai sada rākhiye sang,
 Nadi nār agāh jal tahān bachāo ang.
 Tahān bachāo ang jhapat kutto ko mār,
 Durjan dāwāgīr us ko masak jhār.
 Kah Girdhar kabi rāy likh bhejiye pāti,
 Kamar liye tarwār, hāth men liye lāthi.*

A stick is the kind of thing you should always have with you :

If the water in a river is too deep, you can save yourself by it.

You can also at once save yourself by hitting dogs with it.

And if you meet a wicked enemy you can dust (*lit. trans.*) his head with it.

Saith Girdhar, the prince of poets, write a letter

Telling him to wear a sword in his belt, but to carry a club in his hand.

CHAPTER VII.—BOXES.

656. North of the Ganges सतुख *sanukh* or (in Sāran and South Munger) सन्दुख *sandukh* is an ordinary box. South of the Ganges it is सन्दूक *sandūk*, and in Patna and Shahabad सनुक *sanūk*. A small box is कान्तोर *kantor* or बाकस *bākas* (box). South of the Ganges it is सँदुकची *sandukchi* or सतुकची *sanukchi*, the latter chiefly in Shahabad and the extreme east. पौता *pauta* or पौती *pauti*, or (in South

Bhagalpur) **पौंती** *paunti*, is a little box made of bamboo slips, and **मोना** *mona* (Champāran) or **मौंती** *maunni* are similar ones made of straw or of bamboo slips.

657. **पेटाहा** *petārha* or **पेटाही** *petārhi*, and also south of the Ganges **पेटारा** *petāra* or **पेटारी** *petāri*, is a light travelling box or basket for clothes, &c., carried by a man on a sling bamboo, as in the proverb **थाकल बारद केँ पेटार भारी** *thākal barad keñ petār bhāri*,—for a tired bullock even a basket is too heavy. Other names are **सखारी** *sakhāri* in South-East Tirhut and **भाँपी** *jhāmpi* south of the Ganges and in Champāran. The sling bamboo is called **बहंगी** *bahangi*, or in North-East Tirhut **बहिंगा** *bahinga*; also **सुरला** *suila* in Champāran and North-West Tirhut, and **सिकपटार** *sikpatāi* in East Tirhut.

658. The **डिबिया** *dibiya* is a small box for jewelry or other valuables. In Patna and Gaya it is **डिबा** *dibba*, and in Saran also **डीबा** *dāba*.

659. The **चुनौटी** *chunauti* is a box for carrying the lime (चुन *chūn* or चुन्ना *chunna*) used with betel. In Champāran and North-West Tirhut it is called **चुन्हा** *chunha*.

660. The box in two parts for holding betel, &c., is **पनबहा** *panbatta* or **बेलहरा** *belahra*. Local names are **पनौटी** *panauti* (Shahabad), **पनबही** *panbatti* (Champāran and South-East Tirhut), **बेलहरी** *belahri* (Patna and Gaya), and **बिरहरा** *birhara* (Champāran and East Tirhut).

661. The box in which the **अबन** *abtan*, or cosmetic which is rubbed on the bride at a wedding, is kept is **डोकी** *doki* in Shahabad, and **सोगिला** *sogila* or **सनसोगिला** *sansogila* in the south-east. Elsewhere it is **माला** *māla*, &c. See below.

662. The box used by women for carrying red lead is **सिंधोरा** *sindhora* when large, and **कीया** *kiya* when small. The box in which they carry the vermilion which they put on the parting of their hair is **इंगरौटी** *ingrauti* or **कियाुरी** *kiyauri*. It is also **हिंगोरी** *hingori* in North-East Tirhut and **सपरी** *sapri* in South-East Tirhut.

663. A **माला** *māla*, **मलवा** *malua*, or **मलिया** *maliya* is a box for holding oil. It is also called **माली** *māli* in North-East Tirhut, **तेलहन्दा** *telhanda* in Patna and Gaya, and **तेलहन्दा** *telhānra* in Shahabad.

CHAPTER VIII.—METAL VESSELS USED IN COOKING AND ORDINARY DOMESTIC PURPOSES.

664. The vessels ordinarily used by Hindus are as follow:—

तसन्ना *tasla* or तसन्नावा *taslawā*, made of brass (पीतर *pītar*), a round vessel used for boiling rice. About two *ser*s of rice can be cooked in it.*

665. तसन्ही *tashi*, a similar vessel of smaller size. In Shahabad it is called नौही *tauhi*.

666. बटुवा *batua* or बटु *battu*, a vessel made of alloy (फूल *phūl*, कसन्कुट *kaskut*, or (Gaya) भरिथ *bharith*). This is used for cooking rice, and about a *ser* of rice can be cooked in it. It is comparatively higher and narrower than the तसन्ना *tasla*.

667. बटलोही *batlohi* or (north of the Ganges) बटुली *batuli*, a smaller similar vessel, used for cooking pulse or meat.

668. पतिली *patili* of copper (तांबा *tāmba*) or alloy. It has a narrow flat mouth, and is used for boiling meat.

669. हण्डा *handā*, हाँडा *hānda* (Patna and the south-east), खरखण्डा *kharkhanda* (Gaya), or खँखरहरा *khankhrahra* (Champāran and North Tirhut), is a very large copper vessel for boiling rice. When used by mendicants (फकीर *phakīr*) it is called by them टोकना *tokna*.

670. तामी *tāmi* or तमिया *tamiya* is south of the Ganges a large brass vessel, broad at the bottom, for cooking pulse at marriages, &c.

671. कड़ाह *karāh*. This (to the north-west and in Gaya) is a large iron pan capable of boiling as much as twenty *ser*s of rice.

672. बरगुना *barguna*. This (in North-West Bihār) is a small brass vessel with an erect rim for boiling rice, pulse, &c.

673. कराही *karāhi* or कड़ाही *karāhi*, and to the east and in Champāran लोहिया *lohiya*, an iron or brass broad shallow pan with handles (करा or कड़ा *kara*), generally used for cooking vegetables.

* About this vessel there is a story. Once upon a time all the people of Bhojpur, in Shahabad, were robbers. When a traveller passed through one of these villages, they used to seize his cooking-pot, saying “सवन्ना तोर की मोर *tasla tor ki mor*,”—“Is the pot mine or yours?” If the traveller replied “मोर मोर *mor*,” “mine,” they would set upon him and beat him and rob him of the vessel by force. If he said “तोर तोर *tor*,” “yours,” they used, on his own admission, to take it from him and let him go peaceably. Thus, in any way, they plundered him. Hence the saying सवन्ना तोर की मोर *tasla tor ki mor* has passed into a proverb, of which the application is easy to see.

674. बरगुना *baguna*, an iron or brass cooking-pot with straight edges and a handle.

675. तमहेड़ी *tamheri*, a round copper vessel.

676. तवा *tawa*, तावा *tāwa*, or (Patna and Gaya) तार *tāi*, an iron griddle plate.

677. कटोरा *katōra* to the south and north-east, कचोरा *kachora* in Sāran and Champāran, डुबा *dubbha* in Sāran and Champāran, बाडी *bāṭi* in Tirhut, and मेंहिवाडी *menhibāṭi* in South-East Tirhut, is a vessel used for eating from, with a projection at the bottom on which it stands.

678. The तस्तरी *tastari* (north of the Ganges and in Gaya, Patna, and South Munger), छिपुली *chhipuli* to the east and in Patna, जाम *jām* in Patna, Gaya, and the south-east, and कस्तरी *kastari* in Shahabad, is like the कटोरा *katora*, except that it is flat-bottomed, and has no stand.

679. In the south-east the झरका *jharka* is a deep pan for eating; the कचन पूरी *kanchan pūri*, a shallow one; and the अग्रैल *agrail*, one with the edges straight and short.

680. The थारी *thāri* or थरिया *thariya*, also चोपा *chhipa*, and (in Patna and Gaya) खोरी *khori*, is a flat pan from which food is eaten. The मलंगिया थारी *malangiya thāri* has straight sides, and the मिरजापुरी *mirjāpuri* has curved ones.

681. परात *parāt*, a large flat pan like the थारी *thāri*, except that its sides curve gradually up to the top.

682. ठाँठी *thānṭhi* or टाँठी *tānṭhi* is a dish like the थारी *thāri*, but made of bell-metal (काँसा *kānsa*).

683. दबू *dabū*, a brass or iron spoon, of which the bowl is deep and broad, principally used at marriages.

684. कलहुल *kalchhul* or करहुल *karchhul* is a spoon. कलहा *kalchha* in South-West Shahabad means an iron spoon, and कलही *kalchhi* in Sāran, Patna, and Gaya a brass or iron one.

685. North of the Ganges and in Shahabad चनौटा *chhanauta* or झरना *jharna*, and in Patna, Gaya, and the south भँझरा *ghanjhra*, is a cullender or iron sieve with a handle. In North-West Tirhut it is also called सनौटा *sanauta*, and in North-East Tirhut झँझ *jhānjh*.

686. पौना *pauna* or (South-East Tirhut) पौनिया *pauniya* is an iron cullender or straining-ladle.

687. The लोटा *lota* is used for drawing water and drinking.

688. The गेरुआ *gerua* or हथहर *hathhar* north of the Ganges, Patna, Gaya, and Shahabad, also सोबरना *sobarna* in North-East Tirhut, and झारी *jhāri* in Champāran, Patna, Gaya, and to the south-east, is a kind of *lota* with a spout (टोंटी *tonti*). It is generally made of a white alloy (फूस *phūs*). The माधब सिङ्गी *mādhav singhi* (North-East Tirhut) is a kind of drinking-vessel invented by Mādhav Singh, a former Mahārāj of Durbhanga. It is shaped like a globe surmounted by a funnel. The globe has a spout, and the whole stands on a pedestal.

689. तमहा *tamha* north of the Ganges, and झारी *jhāri* south of it, is a similar vessel made of red alloy (कसकुट *kaskut*). Both the last two are used for drinking.

690. अबखोरा *abkhora* or अमखोरा *amkhora* is a drinking-vessel, the sides of which are broader towards the mouth, and it is provided with a stand (गोड़िया *goriya*) at the bottom. It is also called खोरा *khora*. In Gaya डुब्बा *dubbha* is a large cup, and in South Bhagalpur लोटकी *lotki*.

691. गिलास *gilās* (glass), similar to the last except that the sides are straight or only slightly curved. It sometimes has no stand, and is flat-bottomed. It is, in fact, modelled closely on the lines of a European peg-tumbler, but is of metal.

692. बट्टा *batta* (Patna, Gaya, and North-East Tirhut), a kind of large metal cup. बाटी *bāti* is a small one.

693. गगगा *gagra*, or (in Champāran and Tirhut) तमघैल *tamghail* or तमघैला *tamghaila*, (in Gaya) बसनी *basni*, and (in Champāran, Patna, and to the south-east) कलसै *kalsi*,—a copper or brass vessel used for drawing water from a well.

694. डोल *dol* or कूंड *kūnṛ*, an iron vessel for drawing water from a well.

695. लौहरा *lonhra* or लौहरी *lonhri*, a small iron pan. In the south-west also used for drawing water from a well, like डोल *dol*. North of the Ganges it is also called लोहिया *lohiya*.

696. चोँद *chhounṛ* or मदका *matuka*, a copper or brass vessel for storing water in.

697. The सुराही *surāhi* or सोराही *sorāhi* is used for keeping water. जलधरी *jaldhari* (North-East Tirhut) is a water-pot.

698. **अपघ्ताया** *aphtāba* or **अपघ्ताया** *aphtāya*, a water-ewer used for washing.

699. **चिलिमची** *chilimchi* north of the Ganges, **चिलिफची** *chiliphchi* in North-West Tirhut, **चिलमची** *chilamchi* south of the Ganges, and **सिलफची** *silaphchi* amongst Muhammadans, used for washing.

700. **सरणपोष** *sarpos*, **डकना** *dhakna*, or **डपना** *dhapna*, a cover for other vessels.

701. **मलिया** *maliya* or (Gaya) **मलिया** *malhiya*, a small cup for holding oil. Sometimes it is made of wood.

702. **दीवट** *diyāt* or **दीवट** *dīvat* or **चिरकन्दान** *chirakdān* (north of the Ganges), **बरदगान** *baradwān* (Gaya), and **चिरागन्दान** *chirāgdān* (Shahabad and South Munger), is a lamp-stand. In North-East Tirhut it is **दीथडि** *dīathi*, and in South Bhagalpur **द्विपग्रा** *dīpra* or **द्विपग्रा** *dīpāhra*.

703. **चिमन्टा** *chimta* or **चिजँटा** *siūntha*, also **चूँटा** *chānta*, a pair of small tongs used for arranging the fire or turning over cakes on the griddle.

704. **सँरुसी** *sarṣi*, or (to the east) **बावन्ही** *bāwli*, or in South-East Tirhut **बगुली** *baguli*, tongs used for removing the pot (**बहुली** *batuli*, &c.), from the fire.

705. **खोरना** *khorna* or **खोरनी** *khorni*, also **सरार** *sarāi* (North-West Tirhut). **उटकन** *utkan* (Patna, Gaya, and South Munger), **एकठा** *ektha* (Champāran), and **लोपन** *lopan* (East Tirhut), is an iron or wooden poker. **पिहकर** *pihkar* (Shahabad) is a wooden poker.

706. **राम जिस्ता** *imām jista* or (to the south-west) **हावन दस्ता** *hāwan dasta*, or (South-West Shahabad) **निमदस्ता** *nimdasta*, or (South Bhagalpur) **हमाम दिस्ता** *hamām dista*,—a pestle and mortar for grinding spices, &c.

707. **पिकन्दान** *piikdān* or **पिकदानी** *piikdāni*, also to the west and south **उगदन्दान** *ugaldān*, (in Patna and Gaya) optionally **चिरमिची** *chirmichchi*, and (in South Bhagalpur) **पिरगन्दान** *pirigdān*, a spittoon. To the east and in Patna it is also **पिरिकन्दान** *pirikdān*.

708. **पनन्दान** *pandān* or **पनबहा** *panbatta*,—for keeping betel.

709. **लेवा** *lewa*, or in Patna and Shahabad **लेवन** *lewan*, and in the south-west of the district **लेव** *leo*, is ashes plastered on the cooking-pot to save it from fire.

710. The handful of straw, &c., used for cleaning metal vessels is लूँडा *lūnra* or लुण्डा *lunda*. In South-East Tirhut it is optionally नूँडा *nūnra*. In South Bhagalpur it is नूँरो *nūro*, and in South Munger लुण्डा *nunda*.

711. Musalmāns generally use the following vessels :—

पतीला *patīla*, a large copper vessel for cooking rice.

पतीली *patīli*, देगन्ची *degchi*, or डेगन्ची *degchi*, a similar vessel smaller in size.

देग *deg* or डेग *deg*, a somewhat larger pot for boiling.

बधन्ना *badhna*, the same as the Hindu लोटा *lota*, but with a spout.

बधनी *badhni*, a similar vessel of smaller size.

कटोरा *katora*, similar to the Hindu vessel, but made of copper.

पियाली *piyāli*, a cup.

पियाला *piyāla*, similar to the last, but larger.

रिकाबी *rikābi*, a saucer.

तबाक *tabāk*, जिब्बा *jibbha* in Champāran, or तबाख *tabākh* south of the Ganges, a broad flat washing-vessel.

चिमन्डा *chimta*, &c., the same as used by Hindus.

सरपोस *sarpos*, धकन्ना *dhakna*, or धपन्ना *dhapna*, cover for other vessels.

चिलिमन्ची *chilimchi*, &c., the same as for Hindus.

अफन्ताबा *aphtāba*, the same as for Hindus.

तसत *tasat* or (when smaller) तसन्तरी *tastari*, a broad flat dish.

सेनी *seni* or (in South-East Tirhut) सैन *sain*, a broad shallow tray.

गगग्रा *gagra*, &c., as for Hindus.

लगन *layan*, a large vessel for storing water.

कराची *karāhi*, &c., the same as for Hindus:

भरन्ना *jharna*, हनौटा *chhanauta*, &c., as for Hindus.

पनबट्टा *panbatta*, &c., as for Hindus. The हसुनन्दान *husundān* or (Gaya) कुत्ता *kutta* or कुत्ती *kutti* is similar, and contains additional compartments for lime.

बासन्दान *khāsān*, for keeping *pān* or betel, with a cover.

The **खिलबट्टी** *khilbatti* is used for keeping ready rolled up betel leaves, with the nut and lime inside ready for use (**खिल्ली** *khilli*).

पिकन्दान *pikdān*, &c., as for Hindus.

सोराही *sorahi*, &c., as for Hindus.

Lamp-stands, viz., **फनील सोज** *phatīl soj*, and in Saran also **पटील सोज** *patīl soj*, of brass; **चिरागन्दान** *chirāgdān*, of wood; **दीवट** *dīwat*, &c. (see Hindu articles) of iron; and **बदवान** *badwān*, of bamboo slips.

तावा *tāwa*, &c., as for Hindus.

दस पनाह *dast panāh* or **दस पना** *das pana*, tongs.

सिंखचा *sinkhcha* or **सीख** *sīkh*; also north of the Ganges **गज गज** *gaj*, a spit.

डब्बू *dabbu*, as amongst Hindus.

CHAPTER IX.—EARTHEN VESSELS.

712. The number of these is very large, and varies in each district. The following list does not profess to be exhaustive. It is in alphabetical order.

713. When a new earthen vessel is taken into use, it must first be used by a member of the family and not by one of the servants of the house; otherwise it is considered impure. This is considered as a dedication of the article to family use. To dedicate an article thus is **उदाहब** *urāhab*, or in South Bhagalpur **उदाग्रब** *urhāēb*, and in Saran **उदाओल** *urāōl* or **आवासल** *āwāsāl*.

अरहाया *arhaiya*, a vessel containing two and a half *sers*. In North-East Tirhut it is made of brass.

अथरा *athra*, a pan for making dough. **अथरी** *athri* is a smaller one used (in Gaya) for holding water, washing clothes, and roasting poppy-flower cakes.

अधकर *adhkar* (east), a vessel used in distilling.

अबखोरा *abkhora*, a drinking-vessel.

कंटिया *kantiya* or **कटिया** *katiya*, a little vessel with a long neck. Cows are milked into it.

कत्ती *katti* (Patna, Gaya, and Saran), or **गत्ती** *gatti* (Shahabad), a round potsherd used by boys in playing.

कपट्टी *kapti*, a kind of cup.

कररी *kararī* (South Munger), a water-vessel with a spout.

करन्ना *karna* (Sārau), an earthen vessel in which milk is boiled, also (North-West Tirhut) used for holding curds.

करन्वा *karwa* (West Bihar and South Bhagalpur), a water-vessel with a spout.

करहिया *karahiya*, for boiling milk = कराही *karāhi*.

कराही *karāhi* (north of Ganges) an earthen pan in which clarified butter (घ्यू *ghyu*) is cooked or milk boiled.

कलन्सा *kalsa*, कलन्सी *kalsi* = a घैला *ghaila*, especially when ornamented with lime and colours at weddings, &c.

कसन्तरा *kastara* (south-east), a saucer for holding curds.

कसन्तरी *kastari* (south-east) = तसन्तरी *tastari*, q.v.

कूँड़ *kūnr* (west and Patna), a large vessel for holding grain and food.

कूँड़ा *kūnra* (north of Ganges), an earthen vessel in which sweetmeats or balls of rice mixed with sugar (कसर *kasār*) are given to daughters when going to their father-in-law's house. In South Bhagalpur it is कुण्डा *kunda*.

कुहिया *kurhiya* (South Bhagalpur), a small vessel for milk.

कुण्डा *kunda* (Champanan, Shahabad, and South Bhagalpur), a large flat jar. See also कूँड़ा *kūnra*.

कोहा *koha* or पतुकी *patuki*, a small round wide-mouthed vessel for curds, or for cooking. कोहिया *kohiya* (Gaya) is a smaller variety.

खपन्डा *khapra*, tiles.

खपन्डी, खपन्री *khapri*, or (North-East Tirhut) खापरि *khāpari*, an earthen griddle for making bread or parching grain. When used for parching grain it is made by breaking off the top of a घैला *ghaila*, but that used as a griddle is specially made by the potter. In South Bhagalpur it is also called चहिया *chariya*.

खपन्तौड़ी *khaprauri* (Gaya and West Tirhut), a pot for removing the afterbirth, &c., when a child is born.

खलन्ची *khatchi* (Shahabad), a little platter.

खापरि *khāpari*. See खपन्डी *khapri*.

खावा *khāwa* (South Munger), an earthen cooking-vessel.

खीकी *khikhi* (Tirhut), a vessel for holding oil.

खुम *khūm* (Patna), a large flat jar.

खोर *khōr*, खोरा *khōra* (Tirhut, Patna, and the south-east), a long round earthen vessel used by saltpetre-makers (नोनिया *noniya*) for holding the mother liquor; also (to the east and in Gaya) a large jar used for various purposes.

गगरी *gagri*, a vessel used for drawing water.

गत्ती *gatti*,—see कत्ती *katti*.

गमला *gamla*, a flower-pot.

गुड़की *gurki*, a drinking-vessel, especially for drinking spirits.

घड़ा *ghara*,—see घैला *ghaila*.

घरिल *gharil*,—see घैला *ghaila*.

घरिया *ghariya* (Shahabad), a drinking-vessel.

घुची *ghuchchi* (Sāran), a little dish with a narrow neck.

घुरिली *ghurili*, a little vessel with a narrow neck.

घैला *ghaila*, घैली *ghaili*, घड़ा *ghara*, or घरिल *gharil*, a vessel for holding or drawing water. (See बसनी *basni*, दाबा *dāba*.)

चट्टी *chatti* (Patna and Gaya), an earthen cooking-dish.

चढ़िया *chariya*,—see क्षपड़ी *khapri*.

चरवा *charua*, चरई *charui* (south of Ganges), a vessel for holding grain or for cooking = चेरवा *cherua*.

चिकनी हाँड़ी *chikni hāri*, a vessel for cooking vegetables, pulse, &c. After using it for several months it becomes polished and durable owing to the oil and butter cooked in it.

चिराक *chirāk* (South Tirhut and the west), चिराग *chirāg*, a lamp-saucer.

चिलम *chilam*, the bowl of a pipe.

चुकड़ी *chukri* (south-east), a drinking-vessel.

चुकनी *chukni* (Gaya), a small earthen jar.

चुकड़, चुकर *chukkar*, a vessel with straight sides and a very short neck, used for drinking.

चुका *chukka*, a drinking-vessel.

चेरवा *cherua*, चेरई *cherui* (north of the Ganges and east), an earthen cooking-dish or for holding grain = चरवा *charua*.

चौंपी *chaumpi* (Patna and Gaya), an earthen vessel in which milk is boiled.

बनान *chhanān* (Tirhut, Patna, and Gaya), a vessel with cloth at the top for straining toddy.

बौह *chhonrh* (to the west), a large earthen jar.

बौही *chhonrhi* (north-west), a vessel for keeping water or grain.

जाला *jāla*, a water-jar.

भज्जर *jhajjhar*, a croft for keeping water.

भबन्ही *jhabhi*, an earthen vessel into which cows are milked.

भारी *jhāri*, a vessel with a long spout.

तरिया *tariya* (Champāran and the east), a small oil-pot.

टाड़ *tār*, टाड़ा *tāra* (Gaya), an oil-pot. A smaller variety is टाड़ी *tāri*.

टुँया *tuñiya*, a drinking-vessel.

टूयाँ *tūān*, टूँ *tuñ* (Patna and Gaya and South Munger), a drinking-vessel with a spout.

टेहरा *tehra* (Gaya and South Bhagalpur), a kind of pot for milk.

टौटिया *tontiya*, a tile used as a water-spout at the eave of a house.

डिलिया *thiliya*, a vessel used for drawing water.

डबरी *dabri*,—see डिबरी *dibri*.

डाबा *dāba*, a vessel used for drawing water smaller than a बसनी *basni* and a घैला *ghaila*. In South-East Tirhut, used for boiling milk.

डिबरी *dibri*, and also in Shahabad डबरी *dabri*, same as सनहक *sanhak*, but smaller.

दकना *dhakna* or (east) डाकनि *dhākani*, a cover for other vessels. दकनी *dhakni* is a smaller one.

डिमका *dhimka* (South Bhagalpur), a saucer used as a covering for other vessels.

तरकही *tarkatti*, the vessel in which palm-juice (ताड़ी *tāri*) is collected at the foot of the tree.

तबाक *tabāk* (Patna and Gaya), a little platter (generally of iron).

तसन्तरी *tastari*, a saucer used by Muhammadans. When made of brass, also used by Hindus. Cf. कसन्तरी *kastari*.

तार *tāi* (south of Ganges and Champāran), a griddle for making bread; a kind of shallow pan, with an edge for lifting it up by.

तेलन्हीड़ी *telhāri*, तेलन्हा *telhanda*, a vessel for holding oil.

तेलाय *telāy*, an earthen vessel for cooking oil or clarified butter घू (ghyu).

तौला *taula* (north of Ganges, Gaya, and the south-east), a large earthen dish for cooking.

थपरी *thapri* (Patna and East Tirhut), a vessel for measuring milk.

थाल *thāl*, a platter.

दबन्कन *dabkan* (Gaya), a saucer used as a cover for other vessels.

दवात *dawāt*, an ink-stand.

दहँड़ी *dahenri* or (Patna and Shahabad) दहन्ड़ी *dahri*, for holding tyre (दही *dahi*).

दियरी *diyari* (north of the Ganges and south-west), दियारी *diyāri* (North-East Tirhut), a very small lamp-saucer.

दिउरी *diuri* or दिउली *diuli*, a very small lamp-saucer.

दीप *dip*, a lamp-saucer.

दीया *dīya*, a lamp-saucer.

दीरी *dīri* (south-east and Gaya), a very small lamp-saucer.

देग *deg*, a cauldron.

नदिया *nadiya*, for keeping tyre (दही *dahi*).

नदोद *nadoi* (Gaya), an earthen cooking-vessel.

नरिया *nariya*, a kind of tile (थपड़ा *thapra*).

नाद *nād* or (east) लाद *lād*, a large earthen basin or bowl used as a feeding-trough and for other purposes.

पतिला *patila* (Sāran, Patna, and South Munger) or पतौला *patīla* (Sāran and Gaya), an earthen cooking-vessel.

पतुकी *patuki* (west), a small round wide-mouthed vessel for keeping tyre or for cooking.

पनचोरा *panchora* (south of Ganges), a vessel used in distilling.

परन्हा *parchha* (West Tirhut), a large jar for water.

परार *parāi* (South-West Shahabad), a saucer used as a cover for other vessels.

परिया *pariya* (Patna), a saucer used as a cover for other vessels.

पिठौचा *pitāua* (Patna), a small earthen pan.

पियाला *piyāla*, पेचाला *peāla*, a drinking-cup.

फुच्ची *phuchchi* (South-East Tirhut), a vessel for measuring milk.
 फूरी *phūri* (South Bihar), a saucer used by Musalmāns in feasts of the brotherhood.

बधन्ना *badhna*, a water-vessel with a spout.

बरुका *baruka* (South Tirhut), a drinking-vessel.

बसन्नी *basni*, a vessel for holding or drawing water, smaller than a घैला *ghaila* and larger than a दाबा *dāba*.

बहन्ना *bahna* (Patna and South Munger), a large flat jar.

बिथार *bithār* (Patna), a large dish.

भभन्का *bhabhka*, a vessel used in distilling.

भरुका *bharuka* or भरुकी *bharuki*, a drinking-vessel.

भाँड़ा *bhāura* or भाँड़ *bhāur*, a vessel with a neck for milk or clarified butter (घू *ghyu*).

भुरुका *bhurka*, भुरुकी *bhurki* (in Tirhut), a drinking-cup.

भोजहरौ *bhojahri* (south-east), an earthen dish used by Musalmāns at marriages.

मँगरा *mangra*, the tiles along the ridge of a roof.

मटुका *matka*, and also (south of the Ganges and in Champāran) मटुका *matuka*, an earthen vessel for holding water or grain.

मटुका *matuka* = मटुका *matka*, *q.v.*

मरुतवान *martabān*, मरुतवान *martawān* (south of Ganges), मिरुतवान *mirtawān* (north of Ganges), an earthen vessel with a wide mouth ornamented with lac (लाह *lāh*).

मलुवा *mahwa* (West Tirhut, Shahabad, and South Munger) or मलिया *matiya* (North-West, West Tirhut, Patna, and South Bhagalpur), a vessel for holding oil. It is equally often of wood or metal.

माँट *mānt* (Gaya), a large flat jar.

मिरुतवान *mirtawān* = मरुतवान *martawān*, *q.v.*

मिटिया *mitiya* or मेटिया *metiya*, a round vessel with a short neck for water.

मेटिया *metiya* = मिटिया *mitiya*.

मेठा *meta* (South Bhagalpur and to the west) = मिटिया *mitiya*.

मेढी *meli* (South Bhagalpur), for holding tyre.

मौन *maun*, a vessel for holding date-juice.

रमकरन्वा *ramkarwa* (South-East Tirhut and Champaran), a drinking-vessel.

रकेबी *rakebi* = रेकाबी *rekābi*, *q.v.*

रमचुक्का *ramchukka* (Patna and Gaya), a drinking-vessel.

राइस *rāis* (East Tirhut), a little vessel with a narrow neck, used for holding milk and similar purposes.

रिकाबी *rikābi*, a saucer.

रिकेबी *rikebi* = रेकाबी *rekābi*, *q.v.*

रेकाबी *rekābi* or (Patna and Shahabad) रकेबी *rakebi*, or (south-east), रिकेबी *rikebi*, a saucer.

लबन्ना *labna* (Patna and Champaran), a water-pot in the shape of an ellipsoid.

लबनी *labni*, the vessel in the shape of an ellipsoid, in which palm-juice (ताड़ी *tāri*) is collected from the trees.

लाद *lād* = नाद *nād*, *q.v.*

सनकी *sunki* (South Bhagalpur and Gaya), a saucer used by Musalmans.

सनचक *sanhak*, सनचकी *smhaki*, a broad flat dish used by Musalmans for eating boiled rice.

सरनी *sarbi* (South Bhagalpur), a cup for distributing pulse, &c., from the cooking-pot. Used at marriages.

सुराही *surāhi*,—see सोराही *sorāhi*.

सेफाली *sephāli* (Patna, Gaya, and Shahabad), a flat earthen dish.

सेरहा *serha*, a vessel for drinking spirits.

सोराही *sorāhi* (north of Ganges) or सुराही *surāhi* (south of it), a water-vessel with a long narrow neck.

हँडिया *hanriya*, diminutive of हँड़ी *hānri*, *q.v.*

हँडोला *hanrola*, diminutive of हँड़ी *hānri*, *q.v.*

हथौना *hathauna*, a vessel for collecting date-juice, larger than a लबनी *labni*, used when the juice (ताड़ी *tāri*) flows freely.

हँड़ी *hānri* or हँडिया *hanriya* (small) or हँडोला *hanrola* (small), a vessel for cooking or holding milk, tyre, &c.

CHAPTER X.—WOODEN VESSELS.

714. The कठौत *kathaut* or कठौती *kathauti* is a large wooden dish for kneading flour. It is also called कठरा *kathra* south of the Ganges and to the west, तगाड़ी *tagāri* in Tirhut and Champāran. डगरा *dagra* in Champāran and Gaya is a large flat dish made of wood. The उलन्दी *uldi* in the west, कठुली *kathuli* in Shahabad and South-East Tirhut, कठोली *katholi* in North-East and South-West Tirhut, and कठन्नी *kathli* or अड़िया *arhiya* in Shahabad, is a small wooden dish for scraps. In Patna, Gaya, and the south-east it is पैला *paila*.

715. The कसकौल *kaskaul* (Patna), कित्ता *kista* (Gaya and the south-east), and कवण्डल *kamwandal* (generally), is a wooden cup carried by mendicants. In the north-west नरियरी *nariyari* is an oval one. तूमा *tuma*, तुम्मा *tumma*, or तुम्बा *tumba*, is the mendicant's gourd.

716. सेवन्ती *sevti* or (North-East Tirhut) सौथी *sauthi* is a wooden platter used by sailors.

717. डोकन्नी *dokni* (Sāran and Champāran) and डकन्ना *dhakna* (North Tirhut) are small wooden dishes.

718. The डोई *doi* or (south of the Ganges) डोआ *doa*, or (South-West Shahabad) डोकी *doki* or (south-east) डोउआ *doiü*, is a wooden ladle used by Muhammadans in cooking pulse. The corresponding word amongst Hindus is, in North-East Tirhut, दाबि *dābi*, and in Champāran दाबा *dāba*. घटन्ना *ghatna* in Gaya is a machine for stirring pottage as it is being cooked.

CHAPTER XI.—LEATHER VESSELS.

719. South of the Ganges the मलन्वा *malwa* is used for holding oil. In Champāran it is मलिया *maliya*. कुप्पा *kuppa* or कुप्पी *kuppi* is for holding oil or clarified butter (घू *ghyu*). नदोई *nadoi* is used in Gaya for the same purpose. In North-East Tirhut धोकड़ा *dhokra* is a sack used for the same purpose, as in the proverb गूड़क चोट धोकड़े पुहु जाग *gūrak chot dhokreñ punu jān*,—it's only the vessel that knows the pain (or weight) of the molasses, i.e., only he who suffers, knows the pain. गेल्हा *gelha* is a similar smaller vessel.

गेल्हा *gelha* or (in South-East Tirhut) चमन्डी *chamri* is also a vessel for carrying molasses.

720. मोट *mot* or मोटि *moti* is the large leather bucket for drawing water from a well. डोल *dol* is the smaller one. मसक *masak* is the leather water-skin borne by water-carriers. दस्ती कुप्पा *dasti kuppā* is the small leather bag used by torch-bearers (मसालन्धी *masālchi*) for carrying oil.

CHAPTER XII.—LEAF-PLATTERS.

721. The दोना *dona* is a small round leaf-platter. In Patna, Gaya, and the north-west it is also called खोना *khona*, and in Shahabad खदोना *khadona*. The पत्तल *pattal* is a broader and flatter kind, and is also used as a kind of basket at Hindu marriages when a number of guests are to be fed. It is also called पत्तरी *patri* in Shahabad, पत्ता *patta* in South Bhagalpur, and पत्तरौरी *patrauri* or पत्तमारा *panmāra* in Champāran and North-West Tirhut.

CHAPTER XIII.—STANDS FOR VESSELS.

722. These are made of mud or brick, and known as घिरन्सिड़ी *ghirsirhi* in the north-west, east, and Patna, घिसिरी *ghisiri* in Sāran, घिरन्सिड़ी *ghirsindi* in Patna and Gaya, घिरन्सिर *ghirsir* in Patna and Shahabad, and घिरन्सन्दी *ghirsandi* in South Munger. Other names are घैलन्सारी *ghaisāri* in South-East Tirhut, घलन्सारी *ghalsāri* in South Bhagalpur, घलन्थरी *ghalthari* in North-West Tirhut, घड़ींची *gharaunchi* (South-West Shahabad), and चौतन्ना *chautra* or ओटा *ota* (Champāran).

SUBDIVISION III.

CLOTHES AND ORNAMENTS, &c.

CHAPTER I.—CLOTHES.

723. The general terms are कपन्ना *kapra*, चीर *chir*, and लूगा *luga*. The last has local variants, नूगा *nūga* (South-East Tirhut) and लूगा *luga*, हुन्गा *nunga*, or नूंगा *nūnga* south of the Ganges. Other names, current principally to the west, are पहरावा *pahrāwa*, बस्तर *bastar*, or

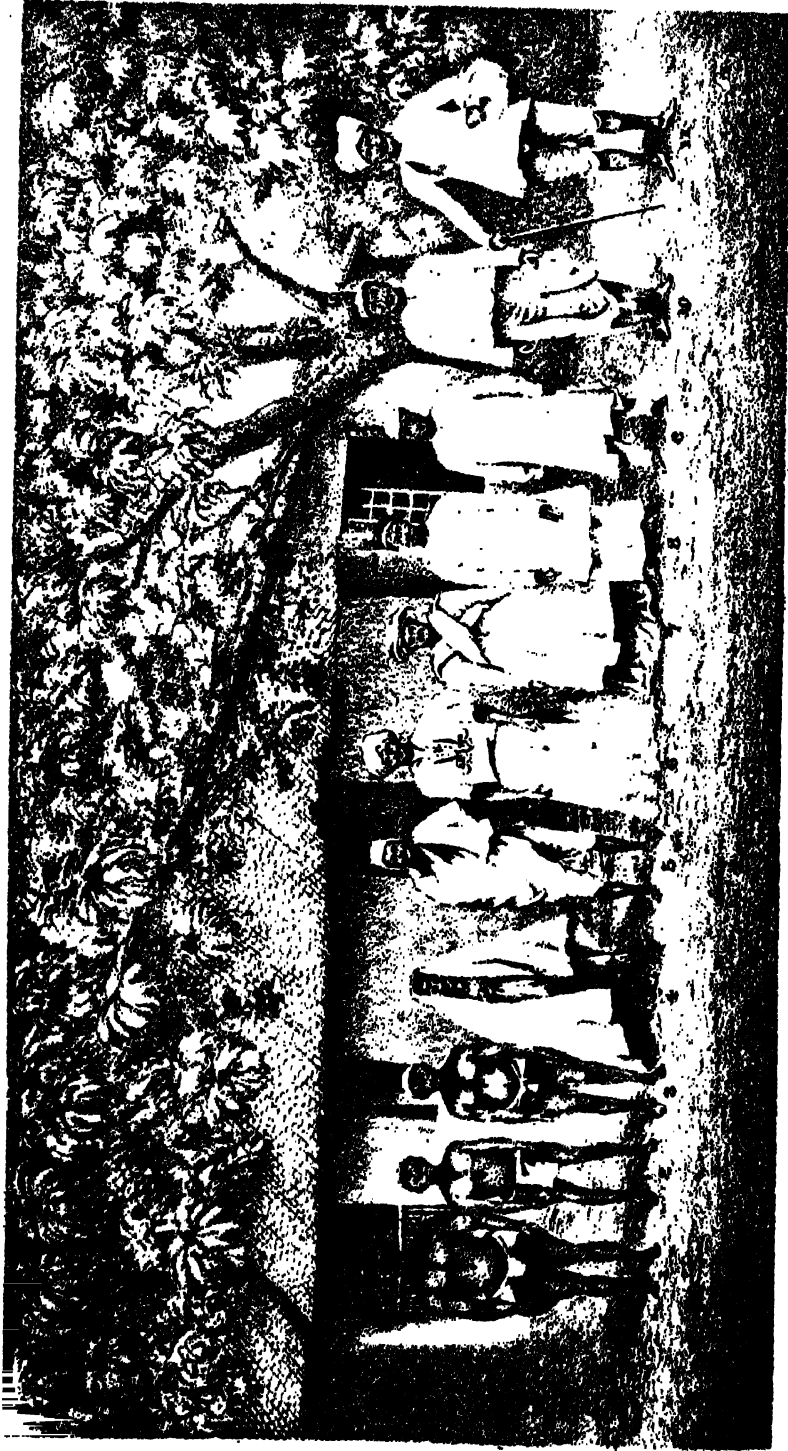

A Bihar Fashion Plate

CLOTHES WORN.

- 1. *Chakr.*
- 2. *Kopli.*
- 3. *Chakr.*
- 4. *Chakr.*
- 5. *Kanjappa; dhoti, dhoti.*
- 6. *Chakr.*
- 7. *Chakr.*
- 8. *Chakr.*
- 9. *Chakr.*

कपडा कला *kapra latta*. A suit of clothes is called पाँचो टुक कपडा *pāncho tūk kapra*, and consists of a turban, loin-cloth, jacket, sheet, and bathing-cloth.

724. Amongst men's clothes are—

The turban.—पाग *pāg*, पगिया *pagiya*, पगड्डी or पगरी *pagri* is a piece of cloth woven for the purpose. The inner portion of the made-up turban (बूत के पगड्डी *būt ke pagri*) worn by the more respectable people is called फेंटा *phenta*. सुरेठा *muretha* is a piece of ordinary cloth, or even a garment, such as the गमन्हा *gamchha*, चद्दर *chaddar*, or दोपटा *dopatta*, worn round the head. चीरा *chīra* is a checked turban. A piece of cloth wound under the chin and over the head is डाठा *dhātha*; also गलौधी *galaudhi* in Patna and East Tirhut, गलमोहा *galmochha* in Tirhut and to the east and (optionally) south of the Ganges, and गलजिन *galjin* in North-West Tirhut and Gaya.

725. The cap is टोपी *topi* or ताखी *tākhi*. The round cap covering the ears worn by Brāhmans is मुण्डा *mundu* in Saran and North Tirhut, कासीवाल *kāsīwāl* in South Tirhut, ताज *tāj* in North-East Tirhut, Patna, and the west, and बभनौ *babhnaū* in Shahabad and South-East Tirhut. दोपलिया *dopaliya* is a long cap made of two pieces, and the चरन्पलिया *charpaliya* or चौगोशिया *chaugoshiya* is round and made of four pieces. The कनटोप *kantop*, कनभप्पा *kanjhappa* (both of these also to the west and in Patna), and कानदार टोपी *kāndār topi* (all north of the Ganges), is a piece of cloth worn loose over the head. South of the Ganges it is कुल्ही *kulhi* or कनभप्पो *kanjhappo* (Patna and South Munger), कनभप्पी *kanjhappi* (Gaya), and कनकोपा *kanjhopa* (South Bhagalpur). कुल्हिया *kulhiya* in Gaya is a boy's cap. घोंघा *ghongha* in Gaya is a wide umbrella-shaped hat of *tāl* leaves, worn in rainy weather.

726. *The loin-cloth.*—This is धोती *dhoti*. North of the Ganges and in Shahabad it is also called मरदानी *mardāni*, and in Shahabad, Patna, and Gaya लुङ्गी *lungi*. The small loin-cloth is लंगोटा *langota* or लंगोटी *langoti*; also in Patna लङ्गोट *langot*. Other names are कोपिन *kopin*, in Champaran कोपीन *kopin*, and in the south-east नंगोट *nangot* or नंगोटा *nangota*. कप्पा *kappa* (east) is a small cloth worn round the waist by the poor. The भगवा *bhagwa*, or in Saran भगई *bhagai* and North-East Tirhut धरिया *dhariya*, is a small *dhoti* principally* worn by

* It is not always worn by boys. Compare the proverb चोरक भगवा डाई *chorak bhagwa dāi*,—burn a thief's loin-cloth, i.e., disgrace him as much as

boys. The बिसन्डी *bisti*, or in Gaya बिकुटी *bichhuti*, is the scrap worn by poor boys. The small tight cloth worn by wrestlers, and also the usual cloth tightened up to allow of free play of the limbs in violent exercise, is काहा *kāchha* or कचा *kachchha*. Other names are चरणा *charna* (Champāran, Patna, Gaya, and the east), चिट *chit* (Patna), समाली *samāli* (Gaya and the south-west), भरकच or भडकच *bharkachh** (North-East Tirhut), and भडकाच *bharkāchh* (South-East Tirhut). तहमद *tahmad*, or in Shahabad तहबन्द *tahband*, and in Champāran तही *tahi*, is a loin-cloth worn by Musalmān mendicants (*fakīrs*). The tag of the loin-cloth tucked in behind is पिहुचा *pichhua* or पहुचा *pachhua* to the west. To the east it is डँका *dhenka* or डँकुचा *dhenkua*. The loose end which hangs down in front is खूंट *khūnt*, सॉची *sānchi* (North Tirhut), and पुच *puchchh* (South-East Tirhut). In South Bhagalpur it is कौची *konchi*. The knot in the loin-cloth for holding money, &c., is फाँड़ *phānr*, फाँड़ा *phānra*, or फषा *phanda*. They are also called चेंड *chent* or डेंड *tent* towards the west, and पेंच *pench* in North-West Tirhut. Other local names are हरिड़ा *harira* (North-East Tirhut), पेड़चा *airha* or मूदी *mūri* (both South-East Tirhut).

727. *The drawers.*—These are पैजामा *paijāma*, also south of the Ganges रजार *ijār* and किसकट *khiskat* (apparently a corruption of the Persian خشک *khīshṭak*). In South Bhagalpur they are also called तमान *tamān*, and in North-West Tirhut सुरवाल *surwāl* (a corruption of the Persian شلوار *shalwār*). According to the Kānūni Islām, the *ijār* and *surwāl* are not so wide as the *paijāma*. Tight drawers are चुड़िदार *churidār*, also चुस *chust* to the west and in South Bhagalpur. If loose at the ankles, they are मोहरिदार *mohridār*; also खल्लेदार *khalledār* in Patna and to the west, बरकाबर *burkābar* in Gaya, and पेंचेदार *painchedār* elsewhere. If loose, with pieces let in along the thigh, they are कलिदार *kalidār*. जंघिया *janghiya* are tight-fitting short drawers, such as those worn by wrestlers.

728. *The jacket.*—This is मिरजारी *mirjārī* and also खुटिया अंगरका *khutiya angarkha*.

729. *The coat.*—This is अंगा *anga*, अंगरका *angarkha*, or चपकन *chapkan*. Those worn by Hindus open on the right breast, and those by Musalmans on the left. It is tied at the neck by a string, खुडी

* Compare Manbodh's Haribans, which is a Maithil poem. कदमक तरु चढ़ि मरुकाच कारि *kadamak taru charhi bharkachh mārī*,—(Krishna) mounted the *kadam*-tree and tightened his loin-cloth.

ghundi or घुंडी *ghūnri*, and also to the east and south सुण्डी *bhundi* or घुंडी *bhūnri*, and in South Bhagalpur सुण्डो *bhundo*, which runs in a hem, तुकमा *tukma*, or (in Patna and Gaya) गाली *gāli*. The अचकन *achkan* is a long loose coat buttoning right down the front. The काबा *kāba* or (south of the Ganges) कबा *kaba* is an outer coat open at the chest and sleeves. The निमासीन *nimāstīn* (also called नीमा *nīma* south of the Ganges) is a jacket the sleeves of which reach only to the elbows, while the शलुका *shaluka* and सदरी *sadari* leave the arms bare.

730. *The sheet.*—This is चदर *chādar* or चादर *chādar*. This is of various kinds, viz. the दोहर *dohar* is a doubled sheet hemmed all round. The गिलेफ *gileph*, सलगा *salga*, or खोल *khol*, is similar, but is not hemmed all round, and is generally made of coarse cloth (मोटिया *motiya*). The एकपट्टा *ekpatta* or एकलार *eklāi* is a sheet made of one breadth of cloth. डेहपट्टा *derhpattu* or डेहपट्टी *derhpatti* is a sheet whose whole breadth is made up by sewing together two cloths, of which the breadth of one is half that of the other. The दोपट्टा *dopta* or दोपट्टा *dopatta* is a sheet whose breadth is made up by sewing together two cloths of equal breadth. उतनी *utni* to the east is an outer garment. To the west it is used (a) for the string tied round a corpse's neck, and (b) for the mourning garments worn for ten days by the करन्ता *karta*, or person who lights the funeral pyre.

731. *The stuffed quilt.*—These have various names, according to the amount of cotton-wool in them, viz. लेंचाफ *lehāph* (five or six *seers*); राजार *rajāi*, नेहाली *nehāli*, or (South Bhagalpur) केहाली *kehāli*, all of which hold from one to three *seers*; and the दोलार *dotāi*, सीरक *sirak*, or (in South Bhagalpur) तुरार *turāi* or सीरग *sirag*, which contain less than half a seer. The stuffing of the quilt is भरना *bharṇa* or (to the south) भराव *bharāv* or भराना *bharāna*. Bits of old cotton padding in a quilt are अङ्गा *anga* north of the Ganges. A similar quilt made of patchwork is गुदरा *gudra* or गुदरी *gudri*. When made of rags it is खेंधरा *khendhra*; also optionally in Tirhut, Patna, Gaya, and the east गेंदरा *gendra*, and in Shahabad लेंदरा *lendra* or लेंदरा *ledra*. See also § 637.

732. *The long coat* worn by well-to-do people is आबा *āba*. The kind of court dress consisting principally of flounced petticoats is जामा *jama*.

733. *The bathing-cloth*, worn round the loins while bathing and used for drying the body afterwards, is named differently by Hindus

and Musalmāns. The former call it **अंगौछा** *angauchha* or **गमच्छ** *gamchha*, a local variant being **अंगौछा** *angochha* to the west. A smaller kind, or *handkerchief*, is **अंगौची** *angauchhi*, **गमच्छी** *gamchhi* **साफी** *sāphi*, **ताुनी** *tauni* (East Tirhut), or **तिउनी** *tiuni* (North-West Tirhut). The Muhammadans call the bathing-cloth **लुङ्गी** *lungi* or **लुंगी** *lungi*. The **हजुरिया** *hajuriya* is a similar bathing-cloth worn by Hindu mendicants (**बैरागी** *bairāgi*).

734. *The purse.*—This is **थैला** *thaila*, **थैली** *thaili*, **बट्टू** *battu*, **बदवा** *batua*, or **बदुरी** *batui*. The **झोरा** *jhora* is a larger bag. In Gaya and to the west it is also **घोघी** *ghoghi* or **धोकरी** *dhokri*. The **बगुली** *baguli* or **तिलदानि** *tildāni* is a tailor's housewife. **लोखर** *lokhar* is the case in which a barber carries his razors, &c. The last is also called **किसमत** *kismat* north of the Ganges and **किसबत** *kisbat* south of it. The *money-belt* is **डोंडा** *donra* or **डोंदवा** *donrha*.

735. *The shoes.*—These are **जोड़ा** *jora*, **जूता** *jūta* (or **जूता** *jutta*), **जूती** *juti*, or **पनही** *panahi*. **जेरपार** *jerpāi*, **खरपा** *kharpa*, or (south-east) **चटका** *chatka*, are usually the shoes worn by women. The wooden bathing-patten with a peg to go between the toes is **खड़ाचौ** *kharāon*, **खड़ाउन** *kharāūn*, or **खड़ाव** *kharāw* (also to the east **खराम** *kharām* or **खराचोनि** *kharāoni*) or **चपटा** *chaptā*, and the clog held on the feet with strings or straps is **बाधा** *bādha* or **बदवा** *badha*. In Sāran and South-West Shahabad **लतरी** *latrī* are old shoes.

736. The Brahmanical cord is **जनेव** *janev*, **जनेउ** *janeu*, or (to the south-east) **जनेउवा** *janeūa*. The knots in the cord are **परग्वर** *pargar* or **परगवल** *parwal*. In Tirhut and South Bhagalpur they are also **परगवल** *parbal*. The **सूत सिखा** *sūt sikha* is the projecting part beyond the knot. The length of the cord is measured by handbreadths (**चौचा** *chaua*). A Brahman's cord is 96 handbreadths long, and so also a Rajpūt's, but the knots are different.

737. *The blanket.*—This is **कम्मर** *kammar*, **कम्मल** *kammal*, or **कम्मरा** *kamra*. In South-West Shahabad it is also **राल** *rāl*. A small blanket is **कम्मरी** *kamri* or **कम्मरिया** *kamariya*. In Champaran and the south-east **धूस** *dhūs* or **धुसा** *dhussa* is a thick kind of blanket. **पचहत्ती** *pachhatthī* is a large blanket five cubits long, and **चहत्ती** *chhatthī* or **छहत्ती** *chhatthī* is six cubits long. **घोगी** *ghogi* is a peculiar way of tying a blanket over the head to save the wearer from rain. In South-West Shahabad it is also called **घोंघी** *ghonghi*, and in Patna and North-East Tirhut **बुकी** *bukki*. The blanket forms the subject of many proverbs: thus **बौं भीजे**

त्यौं कम्पर भारि *jyōñ bhāje*, *tyōñ kammar bhāri*,—the more a blanket is allowed to become moist, the heavier it gets, *i.e.*, delays are dangerous.

738. A *patch* on the clothes is *पेवन pewan*, local variants being *पेवन्द pewand* south of the Ganges and *पौना pauna* in South-West Shahabad. It is also called *पाटी pāṭī* or *पटिया patiya* to the east. Another name is *चेफन्दी chephri* in North-East Tirhut.

739. When cloth is doubled, the *outer piece* is *अबन्ना abru* or (in South Bhagalpur) *पल्ला palla*, and the *lining* *अस्तर astar* or (in Champaran and North Tirhut) *तही tahi*.

740. Among women's clothes are—

The sheet.—This is *सारी* or *साड़ी sārī* generally, with a variant *सरिया sariya* to the east. To the west and in Patna and Gaya it is also called *खिलुआ khilua*. It is also called *लूगा lūga*, with, in East Tirhut, a variant, *नूगा nūga*. In South Bhagalpur it is called *बरन्धली barhatthi* (when 12 cubits long), and in South Munger *खँड़ी khānri* or *खण्डा khanda*. An old torn sheet is *लुगरी lugri*, as in the proverb *नई धोबिनियाँ आइलि, लुगरिये साबुन सारलि narī dhobiniyāñ āli lugriye sābun lāli*,—the new washerwoman has come and applied soap even when washing rags, *i.e.*, a new broom sweeps clean. A proverb of similar import is *नया नोकर खरगोस पकड़तारे, naya nokar khargos pakartāre*,—a new servant will catch a hare, or, as they say in Ireland, a sharp fellow won't let a hare catch him. The smaller sheet worn by poorer women is *जनानी धोती janāni dhoti* or *लुगरी lugri*. Over the *साड़ी sārī* is worn another sheet, called *चदर chaddar* or *चादर chādar*, or (in Gaya and South Munger) *पिछौरा picchaura*. This may be *दोपन्दा dopta* or *दोपद्दा dopatṭa*, as in the case of a man's sheet. The small sheet worn by little girls is *परन्खण्डा parkhanda* to the west and in South Bhagalpur and Gaya *बरन्की barki* in Patna and the south-west. It is *फलिया phaliya* in Sāran and North-West Tirhut, *गँती gāntī* in South Bhagalpur, and *फरिया phariya* in South-West Shahabad. We also find *खेरुकी kheruki* or *खरुकी kharuki*, *खेरुका kheruka* or *खरुका kharuka*, north of the Ganges, and *पुतन्की putli* in South Tirhut, Patna, and South Munger.

741. The hem of the sheet is generally *आँचर ānchar*, and also *आँचरा anchra* or *अचन्ना achra*. This is also the part which covers the bosom. The first of these words is the nominative, and the others are more properly used with postpositions. Thus *ई आँचर बड़ नौमन वा ānchar bar nīman bā*,—this border is very beautiful; but *अचन्ना नै वान्द*

देखौं *achra men bānh delin*,—I tied it up in the hem of my garment. The end of the sheet gathered up and tied in front is फुफुति *phuphuti*, फुफुनी *phuphuni*, or फुफुन्दी *phuphundi* to the west, and कोंचा *koncha* or कोंची *konchi* to the east. The pocket in front formed by loosening the part tied round the waist is खोँचा *khoinchha*, and in the extreme south-east खोचहा *khoechha* or खोंचा *khonchha*, as in the proverb बुड़वक कनेचाँ केँ नौ खाना खोँचा *burbak kancāñ keñ nau āna khoinchha*,—it's a fool of a bride that only gets nine ānās in her pocket (for wedding presents). The loose fold on the left side is गोकनौटा *gojhnauta*. In the south-west it is पिछौरा *pichhaura*. When a woman is modest and meets a strange man, she draws her sheet or veil (see below) before her face. This action is called घोघट *ghoghat*, or in Gaya घुग्घा *ghugggha*, in South Bhagalpur घोघो *ghogho*, and to the north-west घूघ *ghūgh* or घोघ *ghogh*; and when a woman wishes to be extra modest, she pulls a great deal over her face. She is then called बड़ घोघट *bar ghoghat*.*

742. चसन्दार *chasdār* is a dyed cloth with a double-hemmed border worn by women in Shahabad. In the same district मसार्हु *masārhu* is a dyed cloth used by females of the lower orders, and झिमकी *jhimki* is a cloth printed with flower patterns. ककरेजा *kakreja* is a purple, and सालू *sālu* a red cloth, much used everywhere.

743. *The petticoat*.—This is generally लँग्गा *lanhga*. A looser kind is घँघरा *ghanghra* in Gaya and to the east, घँघर *ghanghar* in the south-east, and घँघर *ghānghar* in Shahabad. The घँघरी *ghanghri* is a girl's petticoat. काचा *kāchha* is a mode of tying it under the leg. The waist-band through which the string is run is नेफा *nepha*, and the string itself is रजार बन्द *ijār band*, or in the case of a bride or bridegroom नारा *nāra*. The hem is also called कमर-नोद *kamartoi*.

744. *The bodice*.—This, if it reaches to the waist, is कुरन्ना *kurta*, झूला *jhūla*, or in North-East Tirhut कसनि *kasani*. If it is short, only covering the breasts, it is अँगिया *angiya* or चोली *choli*. A similar short bodice, worn chiefly by prostitutes, is called महरम *mahram*. This last in North-East Tirhut is called चोली *choli*.

745. *The veil* or cloth worn over the head is ओढ़नी *orhni*. When a veil or a sheet (चादर *chādar*) has a dyed border, it is called सुनरी

* As in Manbodh's Haribans, where the wife of Akrūr, although very modest, still wanted to look at Krishna when he came into the house, बड़ घोघट पुन तकलो चारुच *bar ghoghat punu takalo chāhia*.

chunri or चूंदरी *chundri*, and also in Saran जित्की *jitmki*. The border is called in North-East Tirhut पाहि *pārhi* or पहिया *parhiya*.

746. The drawers are पैजामा *pajāma* or (in North-West Tirhut) सुरवाल *surwal*.

747. *Toilet requisites.*—The antimony put on the edges of the lower eyelids is सुरमा *surma*, and the lampblack applied to the eyeball is काजर *kājar*, as in the proverb ठाँव गुन काजर, कुठाँव गुन कारिख *thāmwo gun kājar, kuthāmwo gun kārikh*,—in the right place it is collyrium, and in the wrong place, soot. Lampblack is kept in a box called कजरौटा *kajrauta* or कजरौटी *kajrauti*. The coarser red lead put on the forehead and on the parting of the hair is सेंदुर *sendur* or सेनुर *senur*. The finer kind placed between the eyebrows is ईंगुर *ingur*. The silver spots put on the forehead are called टिकुली *tikuli*, and the round silver spot between the eyebrows is बिन्दी *bindi*. The small silver or gold spots surrounding this are, in North-East Tirhut, बनी *beni* or बेनिया *beniya*. The comb is ककड़ा *kakha*, ककड़ी *kakhi*, or कंगड़ी *kangahi*. It is also ककवा *kakua* in Patna, Gaya, and South Bhagalpur. The लिखगहनी *likhgahni* is a kind of comb used in Gaya. The hair-brush is ठकरी or थकरी *thakri*. To the east झुरनी *jharni* is a kind of brush made of the stem of a cocoanut leaf. A tooth-brush is दतुवान *datuan*. It is made by biting one end of a sprig of wood till the fibres form a brush. Hindus use a fresh one every day, but Musalmāns keep theirs for a fortnight at a time.

748. *Washing of clothes.*—See §§ 389 and ff.

In making clothes, the following terms are used by the tailor or दरजी *darji* :—

पसुज *pasūj* is running, तुरपई *turpāi* hemming or felling, उरमा *urma* is top-sewing, लङ्गड़ *langar* tacking or basting, and चून *chūn* gathering. बखिया *bakhiya* or बखेया *bakhea* is stitching, चाँपा बखिया *chāmpa bakhiya* is long stitching, and डोरी दे के बखिया *dori de ke bakhiya* stitching-in piping-cord. जवा *jawa* is a long stitch and a short stitch alternately, and काँटा फोड़ी पखिया *kānta phori pakhiya* is a kind of stitching for which there is no English name. सुलतान लोदी *sultān lorhi* is a mantua-maker's hem, सारजी *sārji* is herring-boning, and जाली *jāli* a kind of herring-boning for joining two cloths but not bringing their edges together. दरज *daraj* is a run-and-felled seam. When it is narrow, it is called गोल *gol*; when wide, इमलपत्ती *imalpatti*; and when very wide, चौरा *chaura*. There are false hems of various kinds. When

the edges of the two pieces meet evenly, it is called **पट्टी** *patti*; when the edge of the added piece extends beyond the edge of the main piece, the false hem is called, if it is narrow, **मगजी** *maggi*, which properly means the overlapping portion. If it is wide, it is called **सज्जाफ** *sanjāph*. When the overlapping portion is very wide, the false hem is called **लखनवाला सज्जाफ** *lakhnavāla sanjāph*, or in Shahabad **सखनीवाल सज्जाफ** *lakhnauāl sanjāph*. **काज** *kāj* is button-hole stitch, and **हूल** *hul* eyelet-holing.

749. **सिलहरा** *silahra* is a kind of embroidery. Two thicknesses of muslin are sewn together. The under one has holes cut out in it which are embroidered, and are visible through the upper one. It is used as an ornamental border. **बेल** *bel* is similar to **सिलहरा** *silahra*, except that patterns of various leaves, &c., and not holes, are cut in the lower muslin. **सिंघारा** *singhāra* is an embroidered scalloped or vandyked edge. **सोराही** *sorāhi* is a piece of calico cut into an ornamental shape and *appliquéd* on to the shoulder of a coat. **उल्ला मुण्डा** *ulla mundha* is binding an armhole with piping-cord. **कण्ठा** *kantha* is a rounded collar sewn in front of the coat. A sleeve is said to be **चुड़िदार** *churidār* when it is gored to fit tight at the wrist. A gore is **घोर** *ghor*. There is no Bihāri equivalent for "dart," "pleat," or "tuck."

CHAPTER II.—CARPETS AND MATS.

750. A floor-cloth is **कालीन** *kālin* south of the Ganges, north of the Ganges **आजिम** *jājim*, or (to the west) **फरस** *pharas*. A carpet is **दारी** *dari*, or when larger **सतरन्जी** *satranjī*. A **गलेचा** *galaicha* or **गलौचा** *galoucha* is a thread mat. **चट्टी** *chutti* in South Bhagalpur is a canvass mat, and **चाली** *chāli* in Gaya is a coarse kind of mat made of bamboo slips tied together.

751. **चटार** *chatāi* or **चटेनी** *chataini* is a mat made of various reeds or bamboo slips. A **गोनरी** *gonri* or **गोंदरी** *gondri* is made of the *gond* reed. In Patna, Gaya, and the south-west **सफ** *saph* is a long *gond* mat used when a number of people are assembled at a marriage, &c. In the north-west it is **डादा** *dhārha*, in South-East Tirhut **चटान** *chatān*, and in North-West Tirhut **बरहत्था** *barhattha*. A **तराय** *tarāy* to the east is made of palm leaves, and a **तररी** *tarāi* in Cham-paran of reeds. **सितलपाटी** *sitalpatī* is a fine mat for sleeping on in the hot weather. When a number of Musalmāns say prayers together on one carpet, it is called **आनिमाज** *jānimāj*, or in South Munger **जायनेमाज** *jāynemāj*; and when on a mat, it is called **सफ** *saph*.

CHAPTER III.—JEWELRY.

752. The following are some of the varieties of jewelry commonly worn :—

a.—Worn by Men and Boys.

753. *On the ears.*—बाली *bāli* or (in Shahabad) बारै *bāri*. This is a ring. Also the कनौची *kanausi* (Patna and Gaya, where it is worn by Hindus only). Other ear pendants are मोती *mōti*, गोखुला *gokhula* (and to the west also गोरखुल *gorikhul*) (an ornamented ring), कुण्डल *kundal* (a large ring), लोर *lor* (worn principally by Goālas), and कननाला *kanbāla*. सोना *sona* is a plain ear pendant, and अन्ती *anti* is a plain stud fixed in the lobe of the ear. फिरकी *phirki* is a double gold ring.

754. *On the arms.*—The बाँक *bānk* and चौकन्टा *chauktha* are worn on the right upper arm. So also the बिजावठ *bijāwath* or बिजौठ *bijautha*, which is, however, more properly a female ornament. The अनन्त *anant* and तावीज *tāvij* are various kinds of amulets.

755. *On the neck.*—The माला *māla* is the bead necklace. The उदन्राह *udrāhh* is one made of the seeds of the बद्राह *rudrāhh* (*Eleocarpus ganitrus*). The कण्ठा *kantha* is a necklace with gold and silver ornaments or sacred relics attached to it. The मुँगवा *mungwa* is a coral (मुँगा *mūnga*) necklace, and the मोहर माला *mohar māla* or मोहन माला *mohan māla* is a long necklace of gold *mohars* and coral. The गोप *gop* is made of twisted gold wire, and it is also called घुनन्ची *ghunsi* in Champāran, North Tirhut, and South Munger. The सिकरी *sikri* is a long chain going round the neck.

756. *On the fingers.*—This is अँगुठी *anguthi*, ऐँठुआ *ainthua* (Gaya), or औँठी *aunthi*. The गोरख धन्हारी *gorakh dhanhāri* or गोरख धँधारी *gorakh dhandhāri* is a puzzle-ring which takes to pieces and is difficult to put together again. मुँदरी *mundri* is a ring worn on the right little finger. गोल *gol* (Shahabad) and फेरुआ *pherua* (Patna and Gaya) are kinds of rings.

757. *On the wrist.*—These are बाला *bāla* or (Patna and Gaya) बलेआ *balea*, पञ्ची *pahunchi*, and also (south of the Ganges) पञ्चारी *pahunchāri*, करा *kara* (south of the Ganges), बेरा *bera* in Gaya and to the west, जिग्गा *jigga* in Sāran, मठिया *mathiya* in South Bhagalpur, and तोड़ा *tora* in South-West Tirhut. These are worn principally by boys. तैन्ती *tainti* is a kind of amulet in South Munger, Gaya, and Shahabad.

758. *On the waist.*—The chain hung round the waist is करन्धन *kardhan* or करन्धनी *kardhani*; also हरन्हरा *harhara* in the east. A kind of belt is लौंगर, and of this जावा *jāwa* or जवारी *javāri*, लंगड़ा *langra* and जरे *jai*, are portions of the clasp.

759. *On the ankles.*—A boy's anklet is गोड़ाँव *gorānw*, गोड़ाँय *gorāin*, or कड़ा *kara*. South of the Ganges we also meet गोड़न्हा *gorha*, घुंघुर *ghunghur*, or घुंघरु *ghunghru* (fitted with bells, used also in Tirhut), and चौरासी *chaurāsi* (when it carries 84 beads).

760. *On the toes.*—अंगुठा *angutha* is a toe-ring.

b.—Worn by Women.

761. *Ornaments for the head.*—The ornamented hair-pin is चोंटी *chonti*.

762. *Ornaments for the forehead.*—The मँगटोका *mangtika* or बननी *banni* is an ornament tied in the centre of the forehead by three strings, one passing round each side and the other over the top of the head. They are fastened in the hair. Of this the ornament is called चौकन्दा *chauktha*, and the strings सिकरी *sikri*. The spangles or wafers gummed on to the forehead are टिकुली *tikuli*. Another name in South-West Tirhut is सिसफूल *sisphul* or चाँद *chānd*. In Shahabad सटिया *satiya* is a wafer made of embossed paper and gummed on the forehead.

763. *Nose-ornaments.*—The nose-studs fastened on to the outside of one nostril is छुछी *chhuchchi*, in South Bhagalpur नकचन्दा *nakchanda*, and in Patna and to the south-west लौंग *laung*. It is not an easy thing to steal, hence the proverb कहावे लै सैयद चौरावे लै छुछी *kahāwai lai saiyad, chorāwai lai chhuchchi*,—by name he is a *saiyad*, but he can steal even a nose-stud. The ring passing through the outside side of the nostril is नथ *nath*. A smaller kind is नथिया *nathiya*, and that worn by girls नथुनी *nathuni*. The बुलाक *bulāk* or बिसर *besar* is a ring hung from the centre cartilage of the nose, and the झुलनी *jhulni* is a similar one worn by women of the *Rauniyār* caste. It swings backwards and forwards, and is ornamented with beads.*

* Nose-ornaments are peculiar to females. If a mother loses a first-born son she endeavours to persuade the demon who kills children that any future boys born are only girls, and hence not worth killing. To do this, she often makes the boy wear nose-ornaments, and calls him by some nickname, as *Bulāki* (wearer of a nose-ring), &c. There are other similar customs, such as giving opprobrious names to such sons who are born after the death of a first born, which it would take too much space to mention here.

764. *Ear-ornaments.*—Ear-studs fastened to the lobe of the ear are करनफूल *karanphul* or कनफूल *kanphul* and खोटहा *kholla*, or in East Tirhut खुटला *khutla* or खुडी *khutti*, to the north-west खुटली *khulli*, and in Gaya and Shahabad खुटिला *khutila*. The कनैली *kanaili* is a stud worn on the cartilage just where it leaves the head under the hair. Rings worn in the lobe of the ear are बाली *bali*, and those worn in the upper part of the cartilage उतरना *utarna*. Broad plates worn across the ear are पत *pāt*, पत्ता *patta*, and तरकी *tarki*. A smaller kind worn in Gaya is called गोलवा *golwa*. Amongst pendants are the झूमक *jhūmak* or झुमक *jhummak*, which has two round pendants, and the ज्जिम-ज्जिमिया *jhimjhimiya*, which are flat pendants. The मछरिया *machhariya* is a pendant shaped like a fish. In South Munger it is called मछलिया *machhaliya*. The लोर *lor* and कनौसी *kanausi* form a set of ear-ornaments. The first are round plates with a square cut out of the inside, forming a kind of ring with a square inside. One of these is hung in the lobe of each ear. The latter is a ring. One is hung in the upper part of the cartilage of the right ear, and two in the upper part of the cartilage of the left ear. When a hole bored in the ear for an ornament is not in use, it may be filled up with a plug, called ठेक *thek*. When the ornaments worn are too heavy for the ear to carry without tearing, a chain is fastened round the ear so as to support the heavier ornaments. This is called सिकरी *sikri*. Other ornaments for the ear are बीड़ *bir* (Tirhut), काँप *kāmp*, and खुबिया *khubiya* in the south-east, and बिजली *biji* in Patna and Gaya.

765. *Neck-ornaments.*—The चन्दर हार *chandar hār* is a long chain. A तावीज *tāwij* is a similar one with an amulet attached. A set of three chains of various lengths is तेलरी *telri*, and also to the north-west तिलरी *tilri*, of five chains पचलरी *pachlari*, and of seven chains सतलरी *satlari*. The सिकरी *sikri* is a long chain, and the बडी *baddhi* is a long chain crossing the chest and going behind round the body. डमेल *humel* is a necklace fitted with bells. Bosses tied to the throat are चम्पा कली *champa kali*, जुगनु *jugnu*, and धोलना चौकी *dholna chauki*. The last is principally worn by the bride at a marriage, and is the first ornament put on before the marriage ceremony. The हंसुली *hansuli* is the solid necklet open in front which goes round the neck, and the तवक *tavak* is similar with pendants in front (worn by Musalmāns). सूति *sūti* in North-East Tirhut is a kind of neck-ring. जवा गोटा *jawa gota*, गहंसडगा

galsatka, गरग्वानी *gardawāni*, and गरग्वी *garsī*, are various neck-ornaments used in Gaya. Other neck-ornaments are चित्तन्हा (South-East Tirhut), कटेशर *katesar* (Champāran, Patna, and South Bhagalpur) or कटसर *katsar* (Tirhut and South Bhagalpur), and खंभिया *khambhiya* (South Bhagalpur). हार *hār* or हरन्वा *harwa* is the general term for a necklace, and मोती माला *moti māla* is a pearl necklace, or one made with beads of the shape of pearls. ललन्री *labri* and दरपन *darpan* are two ornaments worn on the breast in Gaya and South Bhagalpur. A हैकल *haikal*, or in Champāran हैलक *hailak*, is a long necklace composed of flat pieces, generally nine in number. When a man marries a second wife, an ornament is made representing the first wife, which the second wife wears. On the first occasion on which the second wife applies vermilion to her hair, she first puts some on the ornament before applying it to herself. This ornament is called सौतिन *sautin*, or in South Munger सौत *saut*.

766. *On the clothes.*—मनोरी *manori* are ornaments on the veil (सारी *sāri*), and अँचन्री *anchri* on the hem of the sheet.

767. *Arm-ornaments.*—The following are worn by all classes. Highest up on the arm is the बाजू *bāju*, or बाजू बन्द *bāju band*, which is a wide armlet. Below it the बिजावठ *bijāwath*, बिजावठ *bijāeth*, or बिजौठा *bijautha*, which are five ornaments strung together; below that the बिरन्धी *birkhi*, which is smaller. Another name is बिरँटी *birenti*. Below this comes the बाँक *bānk*, made of one piece. It is worn by Hindu women on the right arm, but by Musalmāns on both. Lowest down comes the बसुन्टा *babhuntā*, or to the west बडुन्टा *bahunta*, of five pieces and round. Arm-ornaments worn principally by Hindu women are अनन्त *anant* and टार *tār* or टरिया *tariya*. Similar to the last is also another ornament called बडुन्टा *bahutta*. सिक्न्री *sikri* is a chain worn on the upper part of the arm. जभिया *jhabiya* is a kind of inverted cup hanging from the arm, and to which bells (बचन्वा *bachwa*) are attached; and घुन्डी *ghundi* little ball pendants hanging from the बाजू *bāju* or from an अनन्त *anant*. मुन्डी *mundhi* is a clasp. बरेखी *barekhi* in South-West Shahabad is an arm-ornament worn by women of the *Goāla* caste. Arm-ornaments worn principally by Musalmān women are,—on the upper arm, जौसन *jausan*, पत *pāt* (a flat piece tied on), and बजुन्टा *bajulla*, or in Saran बिजुलि *bijuli* (worn immediately below the बाजू *bāju*); and on the forearm नौनगा *naunaga* or (in North-East Tirhut) नबग्रह *nabgrah* of (nine stones). An

ornament worn on the back between the shoulders is called by Hindus पान *pān* or पनवा *panwa*, and by Musalmāns बलमटार *balamtār*.

768. *Wrist-ornaments* are कंकना *kankna*, कंकनी *kankni*, or कंगना *kangna*, or in Champāran ककना *kakna*, कचनरा *kachra* (Gaya and the south-east), कतवा *katwa* (Gaya and the south-east), कतरौ *katri*, कँसौठी *kansauthi* (Gaya and the south-east), खसिया *khasiya*, गोलवा *golwa* (Gaya and the south-east), चूर *chūr*, चुरी *chūri* (bangles), छन *chhan* or छन्द *chhand*, जरै *jarai*, जिगा *jigga*, टोड़ा *tōra*, तिनखण्डी *tinckhandi*, तिनगना *innaga*, तिसिथौटा *tisiauta* (Gaya and the south-east), नघुरी *naghuri* or निगहुरी *nigihri*, or (in Gaya and the south-east) लघुरी *laghuri*, पचखण्डी *pachckhandi*, पछेला *pachhela* or पछेलिया *pachheliya*, पटनरी *patri*, पटनवा *patwa*, पङ्ची *pahunchi*, बँगुरी *banguri*, बड़न्हरा *barhara*, or in Gaya बड़न्हर *arhar*, and in Champāran बेलहरा *belahra*, बाला *bāla*, बाँहू *bānhu*, बेरा *era*, बीखा *baunkha* (Gaya) (made of thread), मथिया *mathiya*, उपौठी *upauthi* (Gaya and the south-east), and लघुरी *laghuri* (see नघुरी *naghuri*). The समन्धेबन्द *samseband* is a keeper worn on the wrist to prevent the चूर *chūr* falling off.

769. *On the fingers.*—A ring is अँगुठी *anguthi*. A round solid ring is चहला *chhalla*. Other names are अँठी *anuthi* and अँधुआ *ainthua*. The गोरख धन्धारी *gorakh dhanhāri*, &c., is the same as that worn by men; so also the गोल *gol* and फेरुआ *pherua*. Other rings are तिनखलिया *tinckhaliya*, बड़न्लोठी *bahloli*, अँगुष्ठाना *angustāna*, आरन्वी *ārsi* which has a small mirror attached), मुँदरौ *mundri*, लोभेरुआ *lobherua* (south-east), दरगबादादी *daryābādī* (*ib.*), पथरौठी *pathrauti* (*ib.*), विरौगिया *viraugiya* (*ib.*), अँखुआ *ankhua* (South Bhagalpur), मथानी *mathāni* (South-East Tirhut), बदामी *badāmi* (Tirhut), पोर *por* (*ib.*).

770. *On the waist.*—Waist-chains and bands are करन्धनी *kardhani*, सरकस *kamarkas*, झब्बा *jhabba* or झबिया *jhabiya*, गठौरा *gathaura*, चँवरा *ncara*, कोचबन *kochban*, कमरजेब *kamarjeb*, सीपी *sīpi*, जाफरी *jāphri*. The कोधन्ही *kothli* is a kind of pocket tied to the waist.

771. *On the feet.*—The ornament fitting on the ankle and covering and fitting on to the upper part of the foot is पाँव जेब *pānw jeb*. Like it are पावट *pāwat*, पैरी *pairi*, and पाँव सङ्कर *pānw sankar*. Over this comes the चर्रा *charra* or चहारा *chhara*, a number of fine rings like the चुरी *chūri* on the arm; over this again the कड़ा *kara*; and at the top the चूर *chūr*. The पैजनी *painjni* are anklets with bells; so also किंकिनि *kinikini* and घुघुर *ghughuru* or घुंघुर *ghunghuru* in Gaya and North-East Tirhut.

772. *On the toes*—are **अँगुठा** *angutha* and **चहला** *chhalla*, which are rings. An ornament fitting over all the toes is **बिछिया** *bichhiya*. In Gaya and the south-east **बदुरी** *baturi* is a toe-ring to which bells are fastened.

SUBDIVISION IV.

APPLIANCES USED IN WORSHIP.

773. The appliances of a Hindu temple are as follows:—The **आसननी** *āsni* is a sort of mat made of *kus* grass, wool, &c., for sitting on.

774. A spoon for throwing water on the *lingam* is known as **आचमनी** *āchmani*; also **अचमनी** *achmani* in South-West Shahabad, **आंचौना** *anchauna* in Gaya, **आंचौनी** *anchauni* in Sāran, and **कलही** *kalchhi* in South Tirhut.

775. The **जलपातर** *jalpātar* is a vessel in which water is kept, and a smaller kind is **पंचपातर** *panchpātar*. The **अरघा** *argha* is the saucer made of stone or metal in which the stone representing the *lingam* is placed. The **पीन्डी** *pinri* or **पिन्डी** *pindi* is the platform on which the *lingam* is placed. Other names are **सरार** *sarāi* (optional) in South-East Tirhut, **चौरा** *chaura* in South-West Shahabad, and **जखार** *jakhār* in the rest of that district.

776. **घण्टा** *ghanta* or **घड़ी** *ghari*, also south of the Ganges **घण्ट** *ghant*, are gongs or bells, and the **बिजघण्ट** *bijghant* is a kind of gong with erect edges. **घण्टा** *ghunta* specially means a bell; **झांज** *jhānjh* (small) or **झाल** *jhāl* (large) are the cymbals. **सङ्क** *sankh* is the conch.

777. The idol is **मुरत** *mūrat*, also **मुरती** *murti* in South Bhagalpur, and **पारखत** *pārkhāt* optionally in South-East Tirhut. Its base is **सिंगासन** *singāsān* or (in Patna and Gaya) **सिंघासन** *singhāsān*.

778. **होरसा** *horsa*, or in the south-east **होरसा** *horsa*, round stone for grinding sandal-wood (**चन्दन** *chandān*). Another is **चन्द्रौटा** *chandrauta*. The vessel in which the ground sandal is placed is **कटोरी** *katori*.

779. The censer is north of the Ganges **धुपदान** *dhupdān*, in Patna and Shahabad **धुपदानी** *dhupdāni*, in Gaya **धुपचकरा** *dhupchakara*, and in the south-east **धुपेड़ी** *dhuperi*.

780. The **दिपदान** *dipdān*, **दिपदानी** *dipdāni*, is the vessel holding only one lamp or wick. One with four or five lamps is called **आरती** *arti*.

781. The सुमिरन्नी *sumirni* north of the Ganges and सुमरन्नी *sumarni* south of it is the rosary of nineteen beads. In Champāran and Gaya it is also सुमेर *sumer*. माला *māla*, or in Saran and Tirhut करमाला *karmāla*, is a similar rosary of one hundred and eight beads. सुमरन्नी *sumarni*, &c., are also used for the large bead at the end of a माला *māla*. A-जापमाला *jāpmāla* is a large rosary containing as many as a thousand beads. The अष्टोत्तरी *ashtotri* or अथोत्तरी *athotri* is a rosary which is kept in a small bag called झोरा *jhora*. Into this bag the worshipper puts his hand and turns the beads. The बद्राख *rudrākh* is a rosary used by worshippers of Shiva, as in the proverb बापक गरे मुंगरी, पूतक गरे बद्राख *bāpak gare mungri, pūtak gare rudrākh*,—the father has a club on his neck, and the son a rosary, *i.e.*, the father is a scoundrel and the son a devotee.

782. The तूमा *tūma*, तुम्मा *tumma*, or तुम्बा *tumba* is the hollow gourd carried by religious mendicants (बापू *sādhu* or जोगी *jogi*). It is also called कठारी *kathāri* or सागर *sāgar* in Saran and Tirhut. The तुमन्दी *tumri* is a small gourd. The कमण्डल *kamandal* is a similar vessel used for drawing water in a temple. A दण्ड कमण्डल *dand kamandal* is a similar vessel made of metal (brass, copper, gold, &c.)

DIVISION III.

SOILS.

CHAPTER I.—CLASSIFICATION OF SOILS.

783. Soils may be classified—

- (a) According to their distance from the village site.
- (b) According to their constituent elements.
- (c) According to the crops for which they are prepared, or which they usually produce.

CHAPTER II.—SOILS CLASSIFIED ACCORDING TO THEIR DISTANCE FROM THE VILLAGE SITE.

784. The concentric circles (बसन्का *halka*) are generally, but not always, three in number. The nomenclature and division differ according to locality.

- (a) The belt near the homestead, which is better manured, more carefully cultivated, and adapted for superior kinds of crops. The homestead is called अब्बादी *abādi*, डीह *dih*, बसन्ती *basti*; and the belt of land गोएँड़ *goënr*, गोएँड़ा *goenra*, गौँड़ा *gonrha*, or गौँड़ा *gaunrha* or बाघ *bādh*; also कोरार *korār* in Patna and to the west, दिहँस *dihāns* (Shahabad, Patna, and Gaya), घरबारी *gharbāri* in Patna and South Munger, and बाड़ी *bāri* in South Bhagalpur. The land actually in the homestead is specially called डीह *dih*, दिहँस *dihāns*, or (in Tirhut) भीठा *bhitha*, and in Champaran भीठ *bhith*. डीह *dih* is properly an old village site or mound. If there are two clusters of dwellings of the same name some distance apart, the older one will be called डीह *dih*. अब्बादी *abādi* is properly settled or cultivated land. The land near the village which receives the drainage of the houses is गोहान *gohān* in Shahabad.

- (b) The next furthest belt from the village site is बहरसी *baharsi* to the west and in Patna and South Munger. This belt is also called सरेह *sareh* to the south-west as long as crops are standing on it. It is also called ताधी *tādhi* (Champaran), बहरन्मू *baharbhūm* (Saran and Tirhut), टाल *tāl* (South-East Tirhut), बहियार *bahiyār* (North-East Tirhut), and बैहार *baihār* (South Bhagalpur). In Hazārībagh it is called सिङ्गा *singha*.
- (c) The belt furthest from the village site is also called सरेह *sareh* to the west, also बहरन्मू *baharbhūm* in South Munger. So that the second and third belts are only considered as one. There are also, however, separate names for the third belt, viz. टाड़ *tār*, टाँड़ *tānr*, or टाँड़ी *tānri*, which is used to mean high extensive wastes of infertile or gravelly soil, or of hillocks and ridges such as are found in Gaya, and चौर *chaurnr*, which means low open marshy country. In South Bhagalpur भौठो *bhūtho* is the land far from the village site which only produces bhadoi crops with much labour, and a still further circle is बरन *baran*, which bears no produce. In Saran and Tirhut दीयर *diyar* are the fields situated on the further side of a river, or islands formed by rivers.

CHAPTER III.—SOILS CLASSIFIED ACCORDING TO THEIR CONSTITUENT ELEMENTS.

785. *Sandy soils.*—बाला *bāla* or बलवा *balwa*, बलथर *balthar* (North-West and in Patna and in Gaya), बलवाह *balwāh* (South Bhagalpur), and बलधूस *baldhūs* (Champaran), are soils principally composed of sand. Sandy loams are बलन्दर *balsundar* or बलसुन्दरी *balsundri*, with local variants बलसुन *balsun* or बलसुन्ही *balsumhi* in South Tirhut, बलकसी *balkasi* in South-East Tirhut, and बलसुम *balsum* in North-East Tirhut. They are also called बलुवट *baluat* to the west, and बलिमत *balimat* in Shahabad. North of the Ganges and in South Munger बलुवा *balua* is land with sand on the surface and clay at some distance below. In Champaran and South-West Tirhut धूस *dhūs* or धूसी *dhūsi* is an arid and sterile soil consisting of an admixture of sand and clay. A loose sandy subsoil, in which a clay well will not work, is बेंगा *benga* or बेंगवा *bengua*. In South-East Tirhut it is also

सुसुनी *bhusni*. In Shahabad नीस *bhis* is fine compact sand, and बाला *bāla* loose coarse sand.

786. *Clayey soils*.—The principal is मटियार *matiyār*, or in Gaya मटिगर *matigar*, which is a brown clay soil, well adapted for rice. It contains about 60 or 70 per cent of clay. A stronger kind, containing about 85 per cent, is called केवाल *kewāl*. This is also called करार *karār* in the south-east. केवाल *kewāl* in South Munger is of three kinds, viz. करन्का *karka*, which is black; गोरिचट्टा *goriatta*, which is yellowish; and चमन्की *chanki* or गगरी केवाल *gagri kewāl*, which is mixed with fine gravel. This last is also called पथरटिया *pathratiya* in South Bhagalpur or (when it is of a reddish colour) गोरटिया पथरौटी *gorentiya pathrauti*. In South-East Tirhut केवाल *kewāl* is of two kinds, viz. गोरी केवाल *gori kewāl*, which is light-coloured, and तेलिया केवाल *teleya kewāl*, which is dark. करैल *karail* to the west is a bluish-black soil, which contains more organic matter than मटियार *matiyār*. In Shahabad it is divided into two kinds, viz. बांगर करैल *bāngar karail*, which is apt to crack on drying, and डोमा करैल *doma karail*, which is of a more bluish colour than the other. A clay which feels greasy when rubbed in the hands is called दूधौ *dūdhi* or चिकन मिट्टी *chikkan mitti* or चिकनी मिट्टी *chikni mitti*; and सुसुरी *bhusuri* (west) and कचौस *kachaus* (east) are clay soils which soon dry on the surface. रखौर *rakhaur* is a similar soil mixed with ashes, which is called in South Munger भसुराही *bhusurāhi*. चमन्की *chanki*, or to the west सिगता *sigta*, are hard soils, which split and crack when dry. In Patna and Gaya कछुरिया *kachhuiya* is a loose clay met in digging wells. ललकी मिट्टी *lalki mitti* north of the Ganges, जेरु *geru* south of it, and काबिस *kābis* in South-West Shahabad, is a red clay. नरम *naram*, and also to the east लरम *laram*, are soft when applied to clay. North of the Ganges, to the west, and in South Munger, अकराह *akrah* is a hard clay soil mixed with fine gravel. In South-East Tirhut it is चराही *chharāhi*. रोरियाह *oriyāh* or रोरहा *rorha* is land which goes into hard lumps the size of eggs after preparation. कुमरौटी *kumrauti*, or in Sāran कुमरौटी *kumrauti*, and in Tirhut कारी माटी *kāri māti*, is potter's clay.

787. *Loamy soils*.—The चहाल *chahal* or कदौर *kadoi* is that which is never drier than mud, and in which crops are planted without ploughing. डबरी *dhabri* or डब *dhāb* is land which is part of the year under water and part of it dry. दोरस *doras*, or (in Patna and Gaya) दोरसाही *dorsāhi*, and (in South Bhagalpur) परसोती *parsoti*, and also

पंचकटेल *panchkatail* in Tirhut, is a clayey loam; while बलसुन्दर *balsundar* (see sandy soils for other names) is a fine sandy loam. In Champāran बभनी *babhni* is a light red soil.

CHAPTER IV.—SOILS AND WATER ACTION.

788. Land thrown up by fluvial action is गङ्ग बरार *gang barār* (also spelt बरार *barār*), and that cut away गङ्ग सिकस्त *gang sikast*. चारन *chhāran* is land left by the retrocession of a river. टॉड *tānr* in South-West Shahabad, and पटनपर *patpar* in South-East Bihār, is newly-formed land so situated as to receive an annual accretion of alluvial deposit; but in Sāran and South Tirhut पटनपर *patpar* is barren alluviated land. In Sāran मामस *māmas* is rich alluviated land. In Tirhut, Patna, Gaya, and the south-east नरी *tari* means moist soil in hollows and at the foot of slopes. It also even means water. Thus they say, 'Are you going नरी *tari* (by water) or खसकी *khuski* (by land)?' In Sāran तरयानी *taryāni* is similarly used. नरी *tari* is also applied to lands recovered by retrocession of a river. In Shahabad they are भागर *bhāgar*, and in the south-west of that district चिहलहिया *chhichlahiya*. They are also called चारन *chhāran*. दीयर *diyār* or दियारा *diyāra* is fresh land thrown up by the shifting of the course of a river. In Patna, and also in Champāran, it is called दिचरा *diara*, in South-West Shahabad डीला *dila*, in South Munger दीरा *dāra*, and in South Bhagalpur दीर *dira*. The alluvial deposit left by rivers while still wet is called कदर *kadri*, कदोर *kadoi*, or पॉक *pānk* or पक *pank* (see § 789). Land rendered useless by deposits of sand is called कोरा बाल *kora bāl* (in Sāran) and बलान *balān* (North-West Tirhut).

CHAPTER V.—MUDDY AND WATER-LOGGED SOILS.

789. Land in the bed of a tank is in Patna and Gaya नरी *tari*. In Shahabad it is कौच *kinch*, and to the west generally कानो किचर *kāno kichehar*. Marshy or muddy soils and quagmires are भास *bhās* and दलकी *dalki* to the west and in Patna, and the latter also in Gaya and South Munger. In Tirhut, Sāran, and Patna they are दलदल *daldal*, in Patna and Shahabad पॉक्या *pankha*, and in the south-west of the last district खंचरा *khanchra*. Lands usually saturated with water are पनमार *panmār* north of the Ganges, सुगरा *sugra* in South-

West Shahabad, सिंहरा *siñrah* in the rest of the district, सिंहरा *sirāha* in Patna and South Munger, सीरा *sira* in South Bhagalpur, and सेत *seūt* in Gaya. धसना *dhasna* is land liable to be submerged. It is called गौची *gaunchi* in Gaya and जलकी *jalki* in South-West Shahabad; in South Munger it is गौची *gaunchhi*. The old dry bed of river is चारन *chhāran* or (in North Tirhut) मरन *maran*. Other names are बाँड़ *bānr* in Patna and Shahabad and भोर *jhor* in the south-west of the last district. पाँक *pānk*, पाँकी *pānki*, or पक *pank* is earth wet and soft so as to yield to the tread, adhesive and rotting. Nothing will grow in it. कादो *kādo*, कदो *kadoi*, or कदर *kadaī*, is mud in which crops will grow.

CHAPTER VI.—HIGHLANDS AND LOWLANDS.

790. Highlands, as contrasted with river valleys, are उपरवार *aparwār* in Patna and to the north-west, बहारभूम *baharbhām* in South Tirhut, and उपरार *uprār* in East Tirhut. South of the Ganges दिहांस *dihāns* is used in Patna, टाँड़ *tānr* in Gaya and South Munger, डील *dil* in Shahabad, and डीह *dih* in South Bhagalpur. In Hazāribāgh other names are उचास *uchās* and डीबर *dhibar*. In South Munger गाद *gād* is the corresponding word for a lowland. झील *ihāl* or चौर *chauār*, or in Saran काह *kāchh*, is low marshy land. In Patna, Gaya, and South Munger it is जाह *jāh*. मन *man* is a large sheet of water of considerable depth, and in Tirhut जान *jān* is similar but something smaller. खाल *khāl*, खलवा *khulwa*, or in the north-west खतार *khatār* or खहर *khahar*, is a hollow with or without water.

CHAPTER VII.—RAVINES AND MOUNDS, &c.

791. Land cut by ravines and broken ground is बिहार *bihar* or (in Gaya) बीहड़ *bihanr*. In South Bhagalpur it is अरियन *arian*. The elevated soil in the midst of ravines is दूड़ *dhūh* or दूही *dhūhi* in South-West Shahabad, डील *dil* in the rest of the district, टिहरा *tilha* in Patna, Gaya, and South Munger, and टिकर *tikkar* in South Bhagalpur.

792. In Patna, Gaya, and South Munger टाँरुवा *tañrua* or नाला *nāla* is a ravine. The latter word is also current to the west, and is only used when the ravine is also a water-course. In the south-east

the word is **दाँड़** *dānr*. **डेद कौषा** *derh kaua* is also used in Patna. Uneven ground is **उभर खामर** *ubhar khābar* to the north-west and in South-East Tirhut, and **मठन्हा** *matha* or **डाबर** *dābar* (also in Champāran) in North-East Tirhut. South of the Ganges we have **अबर खबर** *ābar khābar* in Patna, Gaya, and South Munger (also noted in Sāran), **ऊँच खाल** *ūnch khāl* in Patna and to the west, **अखर खावड़** *ākhar khābar* in Shahabad, and **उचन्ही** *uchli* in South Bhagalpur. A high river bluff is **करारा** *karāra*, **अररा** *arra*, **अरार** *arār*, **अरारि** *arāri* or **कहाड़** *kachhār* or **कहाड़ा** *kachhāra*. Other names are **डाह** *dhāh* (north generally) and **कँगनिया** *kanganiya* (North-East Tirhut). The sloping bank of a river is in Shahabad **तरसिवाड़** *tarsiwāi*, and in South Munger **तरि** *tari*.

793. A mound generally is **टिह्हा** *tilha*, or in South Munger **टिह्हा टाकर** *tilha tākar*. In South-West Shahabad it is **दूह** *dhūh*, **दूही** *dhūhi* (also in Sāran), **डील** *dīl*, or **डिहा** *dilla*, in the rest of that district **टीपुर** *tipur*, and in South Bhagalpur **टिकोर** *tikor* or **टिक्कर** *tikkar*. In South-West Shahabad **पटपरी** *patpari* is a hill with a flat top. The sites of ruined villages are **डीह** *dih*; also **भौठा** *bhitha* in South Munger. The sites of old villages are often covered with potsherds, hence such sites are also called **ठिकराहू** *thikrāhu* in Patna, **ठिकरौल** *thikraul* in Sāran, **ठिकरिया** *thikariya* to the east, **झिकटौर** *jhiktaur* in Patna, Gaya, and Champāran, **सिकरौर** *sikraur* or **झिकरौर** *jhikraur* in Shahabad, and **झिकटिया** *jhiktiya* in South Bhagalpur, the words for potsherds being **झिकटा** *jhikta*, **झिकटी** *jhikti*, or **ठीकर** *thikar* or **ठिकड़ा** *thikra*, also **सिकड़ा** *sikra* in Shahabad and **झिकड़ा** *jhikra* to the west.

CHAPTER VIII.—STONY SOILS.

794. Gravelly soils are **कंकराही** *kankrāhi* in Sāran and Patna, **अंकुरैल** *ankrail* in Sāran, and **अंकुरौर** *ankraur* to the west. Gravel generally is in Patna and to the west **आँकर** *ānkar*, and to the east **गङ्गट** *gangat*; also everywhere **कङ्कर** *kankar*. In Champāran and Tirhut it is **इंकुरी** *inkri*, and in Champāran and Gaya **झिकटी** *jhikti* or **गराँगट** *garāngat*. Coarse gravel is in Shahabad **अंकड़ा** *ankra*, and fine **अंकुरी** *ankri*. To the south-east it is **गंगटा** *gangta* and **गंगटी** *gangti*. Soil mixed with coarse gravel is **गंगटियाहा** *gangtiyāha* in Patna, Gaya, and South Bhagalpur, and **गंगटाहा** *gangtāha* in Patna and South Munger. **चटान** *chatān* is a hard rocky soil. Other names are **दोहर** *dohar* in South-West Shahabad, and **पथरेहर** *pathrehar* in South Munger.

CHAPTER IX.—CULTIVATED AND WASTE.

795. Classifying soils according to cultivation, we have cultivated and known as **अबाद** *abād* or **अबादी** *abādi*. It is also known in the north-east and Gaya as **पह** *pah*, in Patna as **खील बैठाखोल** *khil baithāöl*, and Shahabad as **खिलनगर** *khilmār*.

796. An inhabited village is **बसगिन** *basgit* or **बसन्ती** *basti*, and a deserted village **बे छपर** *be chhappar* (unroofed), and also in South Munger **निचिराकी** *nichirāki* (without a light) and in Gaya **दमन्का** *damnka*. Other names for the latter are **उजड़** *ujar*, **उजरल** *ujral*, **उजाड़** *ujar*, **उजाड़ा** *ujra* or (optionally in Tirhut) **डीह** *dih*.

797. Waste land is **परती** *parī* (Patna, Gaya, and South Munger) **परन्ती** *partī*. Land which has accidentally gone out of cultivation is specially **परात** *parāt* in Saran, **पराता** *parāta* to the north-west, and **पारंत** *parānt* or **परन्ता** *parta* in North Tirhut. Waste land broken for the first time is **खील** *khil*, or in the south-east **खिलकट** *khilkat* **खिलकट्टी** *khilkatti*. In Tirhut it is also called **खिलनगर** *khilmār*. The second year after it is broken up it is **खील** *khil* to the north-west, **पह** *pah* in Tirhut, Shahabad, and the south-east, and **पौह** *pauh* in Patna and South Munger. The third year it is called **खेत** *khet* or (in Champāran) **पही** *pahi*, and North-East Tirhut **पह** *pah*.

CHAPTER X.—FALLOW.

798. Land left fallow for sugar-cane from the previous spring harvest till the season for sowing the cane is called **मघार** *maghār*, see § 805. Land left uncropped in the autumn harvest and ploughed during the rains for the cereals of the spring harvest following is **चौमास** *chaumās*, and to the west also **पलिहार** *palihar*. Those lands on which a spring crop is sown without any interval after the autumn crop is cut are called **नारी** *nāri* in Patna and South Munger, and **जरी** *jari* or **जरी खेत** *jari khet* elsewhere south of the Ganges and in Saran. Waste lands which are ploughed up during the rains and cold weather and sown in rice at the commencement of the next rainy season are called **दोतरा चौमास** *dotra chaumās* in North-West Tirhut, **गजाड़** *gajāñr* in South-East Tirhut, **बिरार** *birār* in South-East Bihar, and **कुसहार** *kusahar* in the south-west.

799. Lands left fallow for a time to recover their strength are **परती** *parī* generally. Other names are **परन्ता** *parta* in North Tirhut

and चाँच *chānch* in South Bhagalpur. Land which never lies fallow is अबाद *abād* or अबादी *abādi*. Another name is उठन्नी *uthni* in Champāran. North of the Ganges बल्लौ *rulli* or (to the east) रन्नी *runni* is poor light land which requires to be left fallow for a year or two. It also means land which has lost its fertility. Other words in use are जहूस *jhūs* and हलुक *haluk* to the north-west and in Patna, झूसी *jhūsi* in North-East Tirhut, कोही *korhi* in Patna, चाँच *chhānchh* in Gaya, बंगराह *bangrah* to the south-west of that district, तिलिया कोही *tiliya korhi* in South Munger, and अलन्नी *algi* in South Bhagalpur.

CHAPTER XI.—RICHNESS AND POORNESS OF SOIL.

800. बरियार *bariyār* or गहूरा *gahra*, or in South Munger जैयद *jaiyad*, is the general term used for rich soils. Others are जीगर *jigar* (Patna) and चोखा *chokha* (North-West, Gaya, and South Munger). Poor soils are हलुक *haluk* (North-West Bihār), रन्नी *runni* (see § 799), तपन्नाह *tapnāh* (North-East Tirhut), and ठस *thas*, अबार *abbar* (also in Champāran), or उसठ *usath* south of the Ganges.

CHAPTER XII.—IRRIGATED AND DRY LANDS.

801. Land artificially irrigated is पटौवा *pataua* or पटौई *pataui* to the west. Other local names are पटौना *patauna* South-East Tirhut, and पटाबौल *pataöl* North-East Tirhut and पटहुआँ *patāhuāñ* in Shahabad. In Gaya it is हथघिसेट *hathghiset*, and in South-West Shahabad भरैया *bharaiya*. Land irrigated from tanks or ponds is खानन *chhānan* in Sāran and Patna, फोर *phor* in South-West Shahabad, and elsewhere south of the Ganges मेहवाणी *mehwāni* or (South Bhagalpur) मेहानी *melāni*. When irrigated from wells it is मोटवाही *motwāhi* to the west. Unirrigated land, or land which does not require irrigation, owing to its being, or its capability of being, flooded is अपटा *apta*. If watered after ploughing, it is चिरिकनी *chhirikni* to the west, पचौवाँ *pachauān* in South-West Shahabad, and पनौला *panaula* in the rest of that district. निपनियाँ *nipaniyān* are in Patna unirrigated crops. In South Munger lands which require irrigation are रूना *rūna*, and there and in Sāran those which produce crops without irrigation are हलही *halhi*.

CHAPTER XIII.—LANDS WHICH RETAIN AND WHICH DO NOT RETAIN MOISTURE.

802. This is the division most common amongst natives themselves. The moisture in land is *हाल hal*. Land which does not retain it is *बाँगर bāngar*, and that which does is *भौठ bhūth*, or in North Saran *भाठ bhāth*. Under these divisions come other subdivisions, such as *बलुआ बाँगर balua bāngar* (which is sandy), *मटियार बाँगर matiyār bāngar* (which is clayey), and so on, and *बलुआ भौठ balua bhūth*, *मटियार भौठ matiyār bhūth*, and so on. Crops on *bāngar* lands cannot be cultivated without irrigation, and the expense of cultivation is therefore greater, but the yield more than compensates the outlay, being a third, and sometimes double the amount of *bhūth* produce. The latter lands are sometimes irrigated and sometimes not.

CHAPTER XIV.—LANDS BEARING A SINGLE AND A DOUBLE CROP.

803. Lands which produce only one crop in the year are *एकफसिली ekphasila* or *एकफसिली ekphasili*. In Champāran they are called *एकफसिलिया eksaliya*. *चौमास chaumās* lands (also called *पलिहार palihar* to the west) are kept free from crop during the rains, and tilled for the cold weather crop. Lands bearing two crops in the year are *दोफसिली dophasila* or *दोफसिली dophasili*, or in Champāran *दोफसिलिया dosaliya*. In South Bhagalpur they are *दोसाल dosāl*. Land on which crops are grown all the year round is *तिनफसिली tinphasila*.

CHAPTER XV.—TERMS USED IN CONNECTION WITH DIFFERENT CROPS.

804. The following terms are used in connection with different crops.

805. *Sugar-cane*.—Land prepared for this crop is *उखौव ukhāw* or *उखाव ukhāo*. Land constantly ploughed for cane or any other crop from Asārh to Māgh are *मघात maghāt* in South-East Tirhut, *मघाड़ maghār* in Saran, Patna, and South Munger, *मघरुा maghra* in Gaya and the south-west, and *मघुआ maghua* in South Bhagalpur. Land under cane is *उखारी ukhāri* in Shahabad. *जठहन jathhan* in South Munger is land cropped in the previous year with cane.

806. *Cereals*.—*हरजिन्दा harjinsa* are those lands which grow all crops except transplanted rice.

807. *Garden crops.*—Land suited for growing garden crops is कोरार *korār* in Patna and to the west and कोरियार *koriyār* in Patna and Gaya. Other names are कोरान्त *korānt* (South Tirhut), कैरियार *kairiyār* (Shahabad), बारी *bāri* in Tirhut, and लतिहानी *latihāni* in South Munger. These names apply rather to the use to which the land is put than to the kind of soil, most of them being connected with the word कोररी *koīri*, which is the name of a well-known caste of garden cultivators.

808. *Cotton.*—In Shahabad the following kinds of land are suited for the various kinds of cotton :—

Cotton.	Land.
(1) रड़िया <i>rarhiya</i>	करैल <i>karail</i> .
(2) बड़न्हा <i>banrchha</i>	कोरार <i>korār</i> .
(3) हौवन्ती <i>hewti</i>	बरियार <i>bariyār</i> .
(4) मन्वानी <i>manwān</i>	नद्वानी <i>nadvāñsi</i> .

809. *Pulses.*—Land under gram is called चैता *chaita* in South Bhagalpur.

810. *Maizes, millets, &c.*—Land under these crops is दोतुरा *dotura* north of the Ganges. The word means properly land in which both a rainy season and a cold weather crop can be sown.

811. *Spring crops.*—Light friable soil suitable for these crops is called भीठ *bhūth* or भीठा *bhūtha*, also in Gaya भिठारा *bhithāra*. See, however, § 802.

812. *Rice.*—Rice land is धनन्धर *dhanhar*. In Gaya it is called धन कियारी *dhan kiyāri*, and in South-West Shahabad धनन्धर *dhanhar*.

813. *Land under trees, brushwood, &c.*—Forests are बान *ban* or जङ्गल *jangal*. A grove is बगैचा *bagaicha* or गाछी *gāchhi*. बाग *bāg* is a garden, and बगिया *bagiya* an orchard. फलवारी *phulwāri* is an orchard, enclosed, irrigated, and stocked with fruit-trees. A खाने बाग *khāne bāg* in Champāran and Patna or नजर बाग *najur bāg* in Gaya and Shahabad is a grove attached to a shrine or other building, and growing flowers as well as fruit.

814. A mango grove is बान के बगैचा *ban ke bagaicha*, or in Tirhut गाछी *gāchhi*; a clump of bamboos is बाँस के कोठी *bāns ke kothi* in the north-west, बंसवारी *banswāri* north of the Ganges generally, and बाँसक भीठ *bānsak bhith* in North-East Tirhut. In Patna it is बसेर *buser*, in South-West Shahabad बंसवार *banswār*, and elsewhere south of the Ganges बसाड़ *basār*. In South Bhagalpur it is also called बीठी *bito*, and

in Tirhut ओष *odh*. A young grove of fruit-trees is गङ्गुली *gachhuli* north of the Ganges, also नौराही *naurāhi* in Champāran, नरोर *naroi* in Champāran and Tirhut, and लब गङ्गुली *lab gachhuli* or नव गङ्गुली *naw gachhuli* in Tirhut. Another name is नव पेड़ा *naw pera*. South of the Ganges it is लौगाही *laugāhhi* to the south-east, केड़वारी *kerwāri* in Shahabad, नरोर *naroin* in Patna and South Munger, and नौकेड़ा बगैचा *naukera bagaicha* in Gaya. A belt of trees on either side of a road is पान्ती *pānti* or पँतिवारी *pantiyāri*, and also लखरान्व *lakhrānw* to the west and पान्ता *pānta* in Tirhut.

815. Land producing brushwood is ज़ारा *jhāra* (Sāran and Patna) or बन छिहली *ban chhihuli* (South-West Shahabad). Brushwood is ज़ार *jhār*, ज़ारवा *jhārha*, or to the north-west and in Patna and South Munger झूर *jhūr*. Small stunted brushwood is झखुली *jhakhuli* or झखुरी *jhakhuri* north of the Ganges and in Patna, रौंजी *raunji* in Patna, and झरकण्ठी *zharkanti* in South-West Shahabad. Land producing tall thatching-grass is खदौर *kharhaur* or खदौल *kharhaul*, or south of the Ganges खरहर *kharāhur*. Other names are मुजवानी *mujwāni*, कँड़वानी *kanrcāni* in the north-west, and मुंजवान *munjwān* in Shahabad. In South Munger it is खरेठा *kharaiṭha*. The principal of these grasses are पटेर *pater*, खर *khar* or खरई *kharāi*, राती *rāri*, डानी *dābhi*, इकर *ikkar* or इकरि *ikri*, मूज *mūnj* or झलास *jhalās*. Of the last, मूज *mūnj* is properly the bark used for making string, झलास *jhalās* the leaves used for making rough thatches, काँड़ा *kāṇṛa* the stout lower part of the stalk used for roof-thatching, and सिरकौ *sirkī* the upper or reed part used for making sieves and mats. Reeds are नरकट *narkat*, and the land producing them is नरकान *narkān* in Champāran.

CHAPTER XVI.—LAND IMPREGNATED WITH SALT, &c.

816. Land impregnated with impure carbonate of soda रेह (*reh*) is उसर *ūsar* or उसर *ussar*. Other names are रेहाह *rehāh* or रेहाड़ *rehāḍ* (East Tirhut) and रेहड़ा *rehra* (Patna, Gaya, and South Munger). खारी *khāri* or (South Bhagalpur) खरवा *kharwa* is land impregnated with sulphate of soda. नोनी *noni* south of the Ganges is land impregnated with common salt. Other names are नोनियाह *noniyāh*, नोनियारी *noniyāri*, and नोनहराह *nonchharāh*. In South-West Shahabad चाँप *chāmp*, and in the rest of the district चाँदिल *chāndil*, is उसर *ūsar* land, in which spots of good ground are scattered.

DIVISION IV.

GENERAL AGRICULTURAL OPERATIONS.

SUBDIVISION I.

PLOUGHING AND HARROWING.

CHAPTER I.—PLOUGHING AND HARROWING.

817. To plough is **हर जोतव** *har jotab*, **हर बखव** *har bahab*, or **हर चलाप्रब** *har chalācb*. **हर नाषव** *har nādhav* is properly to yoke the oxen to the plough (also called **हरनी** *larni* in Champāran and South-East Tirhut). Other expressions for ploughing are **सिरावर के घरल** *sirāur ke dharal* or **सरिया के जोतल** *sariya ke jotal* in Champāran, **पैस घरब** *pais dharab* (or **पुस घरब** *puis dharab* in North-East Tirhut) in Champāran and Tirhut, and **दहिन धरेबाव** *dahin dharcāo* in Champāran and South-East Tirhut. One ploughing is **चास** *chās*, and in Gaya and to the west also **बाँह** *bāñh*: thus, **प्रक बाँह** *ek bāñh* the first ploughing, **दो बाँह** *do bāñh* the second ploughing, and so on.

818. The first ploughing is called **पहिल चास** *pahil chās* or **फरनी** *pharni*. In Gaya and Champāran it is **फारन** *phāran*. Lands sown after a single ploughing are **भोकौसा** *bhokaua* in the north-west and **जोता बावग** *jota bāvag* in Champāran and Tirhut. **मघाड़ जोतव** *maghār jotab* is north of the Ganges and in Patna and Gaya the ploughing in the month of Magh (January–February) of lands intended to be sown at the next rainy season. In East Tirhut and Champāran this is also called **चौसाँस जोतव** *chaumāns jotab*. In Gaya and Champāran it is also **मघनाँस चास** *maghāñs chās*, in Shahabad **मघनाँस** *maghwat*, and in the south-west of that district **कुलहर** *kulhar*. In South Bhagalpur it is **माघी चास** *māghi chās*, and in South Munger **मघाड़** *maghār*. The field which is thus ploughed is **बिहार** *birār* to the west and south and **पह** *pah* also south of the Ganges and in Champāran. North of the Ganges it is called **चौसाँस** *chaumāns*.

819. The second ploughing is दोहार or दोहार *dohār*. In Gaya and Champāran it is also called पुरवे *purwe*. Other names are सोमरा *somra* to the north-west and समर *samār* in North-East Tirhut, दोहार *dohār* in Champāran and North-West Tirhut, and दोहरावन *dohrāwan* in South-West Shahabad; and the same names are also applied to the field so ploughed. In the south-east the second ploughing is called चास *chās*, दोहार *dohār* being the third ploughing.

820. The third ploughing is तेहार *tekhār* and also (in Champāran) तेहरा *tekhra*. To the west it is also तेहरावन *tehrāwan*. In the south-east it is दोहार *dohār*. The same terms are used for the land so ploughed.

821. The fourth ploughing is in East Tirhut and Gaya चौहार *chauhār*, and in Shahabad, Gaya, and South Bhagalpur चरचरी *charchasi*. Elsewhere it is चार चास *chār chās*; so also the land so ploughed.

822. The fifth ploughing is पानचास *pānchās*.

823. The phrase used for successive ploughing is एक चास *ek chās*, दू चास *du chās*, and so on. Theoretically there is no limit to the number of ploughings required for some crops, as is shown in the following rhyme current in Gaya:—

सौ चास गन्दा,	<i>Sau chās ganda,</i>
पचास चास मन्दा,	<i>Pachās chās manda,</i>
तेकर चासा मोरी	<i>Tekar ādha mori,</i>
तेकर चासा तोरी	<i>Tekar ādha tori.</i>

—A hundred ploughings for cane, fifty for wheat, half that (25) for rice, and half that (12½) for oilseeds.

824. The ploughing of millets, when they are about a foot high, is बिदास *bidāh*, a local variant being बिदासनी *bidahni* in Champāran, West Tirhut, Patna, and the south-east. In Gaya and Champāran it is कोरन *koran*, and in South Mungera when hoeing is substituted for ploughing, it is कोरनी *korni*. When a rice-field is flooded and then ploughed to kill the weeds, the ploughing is called लेव *leo* in the north-west, लेवा *lewa* in Gaya, and कादा *kādo* or कदवा *kadwa* to the north-west and in Tirhut. In North-West Tirhut it is called मसास *masāh*.

825. In Saran and Champāran ploughing with a plough of which the block is new and full-sized is नवन्धा के जोत *navtha ke jōt*, and

with one which has a small worn block *खिनौरी के जोत khinauri ke jot*. In Tirhut and also in Champāran the corresponding words are respectively *लवठा के जोत lawtha ke jot* and *ठेंडा के जोत thentha ke jot*, and in Shahabad *नवहरा nawahra* and *खुँडेहरा khuntehra*.

826. In rice cultivation, after sowing, the field is lightly reploughed to clear the weeds and cover the seed. This is called *उनाच unāch* to the north-west and in North-West Tirhut, *गजर gajar* in the North-East Tirhut, and *समार samār* in Champāran and South-East Tirhut. In Patna it is *समाच samāch*, in Gaya *बिराच birāch*, to the west and in Patna and Gaya *बिदाच bidāch*, and in Champāran and to the south-east *बिदाचनी bidāchni*.

827. The small pieces of the field which the plough has not touched are *पैस pais* in Champāran and South-West Tirhut and *पुस puis* in North-East Tirhut. In North-West and South-East Tirhut and in Champāran they are *दहिना dahina*, and in Sāran and Champāran *छूटल खेत chhūtal khet*.

828. Cross-ploughing is *बारा ara*, or in Champāran and South Bhagalpur *चार ar*, and in South-East Tirhut *समार samār*. When a field is ploughed round and round in constantly diminishing circuits, it is called *चौकेठा chauketha* or (in Patna) *चौएठा chauetha*, *बारी वाच āri chās* in Gaya, *चौबगली chaubagli* in Champāran and Gaya, and *चौगडिया chaugathiya* or *चौक चौक chauk* to the west. In Sāran and Champāran it is *चौगेठ chaugeth*, in South Munger *भौरिया bhaunriya*, and in North-West Tirhut *चौकेर chauker*. The centre plot in the middle, round which the bullocks have no room to turn, is called *बदखार badhār*, and this is furrowed by taking the plough across it diagonally from corner to corner. Ploughing from corner to corner is *कोनिया जोत koniya jot* or *कोन kon*, also *कोनसी konsi* in South Munger, *कोनसिया konasiya* in Champāran and South-West Tirhut, *कोनी koni* in Gaya, and *कोना कोनी kona koni* to the west. When a crookedly-shaped field has to be ploughed, it is called *अना थोड़ी जोत āna dhyōṛī jot* in Sāran and Patna and *अनाडेही जोत āna derhi jot* in Champāran. When a rectangular field is ploughed straight along its length and breadth, the ploughing is called *सोझौवा जोत sejhaua jot*. Other names current are *ठहरै tharhāiṅ* in Patna and Champāran and *ठरिया tharhiya* to the west. Ploughing breadthways is *फानी phāni* in Sāran and North-West Tirhut, *फटकी phatki* in Champāran and the south-east, *अना फानी āna phāni* in Patna, and *फँदिया phāndiya* in South-West Shahabad.

829. The following rule is current in North-East Bihar as to ploughing and harrowing:—

थोर जोतिहः बहुत हँगरहन, ऊँच के बँधिहः गार ।
 उपजे नः उपजे नाहीं नः पावे दीहः गार ॥
Thor jotiha bahut hengaiha, unch ke bandhiha ar,
Upje ta upje nahin, ta Ghaghhe dāha gār.

—Plough little, harrow much, and have your field boundaries high. If what should come does not then do so, you can abuse Ghāgh (who gives you this advice).

830. A harrow is हँगा *henga*, &c., as described in § 30 and ff. To harrow is हँगाप्रब *hengāéb*, हँगा चलाप्रब *henga chalaéb*, or चौकी घुमाप्रब *chauki ghumāéb*. The act of harrowing is in Gaya पालट *pālat*.

831. The oxen attached to a harrow have various names. The one on the left-hand side is called पँचौट *panchaut* or कुड़न्दिना *kurdahina*, and the one next to him हथौसा *hathaua*. The right-hand ox is घेरा *phera*, or in South Munger भसनी *bhasni*.

CHAPTER II.—FIELDS.

832. A field is खेत *khet*. Other names also current are टोपरी *topri* and पारी *pāri* south of the Ganges, टोपरा *topra* to the west, and डार *dābar* in Champāran and Gaya. In South Bhagalpur the words बारी *bāri* and बहियार *bahiyār* are used. Beds made in a field to facilitate irrigation and for other purposes are कियारी *kiyāri*, and also in Champāran गढ़ारी *gharāri*, in Patna and to the south-east गँडारी *ganrāri*, and in Gaya गेंडारी *genrāri*. Similar beds in a sugar-cane field are called हाता बाहा *hāta wāla* to the north-west and in Gaya and North-West Tirhut, and जोर *jhor* or जोरा *jhora* south of the Ganges. In the north-west जोरा *jhora* is a large bed, and so also are पण्डा *pahta* in Gaya, Sāran, and Champāran, परिया *pariya* in South-West Tirhut, दवान *dawan* in Champāran and North-West Tirhut, and कियारा *kiyāra* or भेर *bher*, in East Tirhut. The raised banks between the irrigation beds are मँडू *menr* in the north-west and आर *ar* in Tirhut. In Shahabad, Patna, and Gaya they are करवा *karha*, and in Patna and Gaya पँरगा *panrga*, in South Bhagalpur पलङ्गा *palanga*, and in South Munger दौग *daug*. North of the Ganges a plot marked off by a boundary is हाता बाहा *hāta wāla* in the north-west and South Munger and चरकी बाहा *chharki bāla* in East Tirhut. The small patch

of ground adjoining a house is कोला *kola*, कोली *koli*, or कोलवार *kolvāi* to the north-west, and बारी *bāri* in Champāran and Tirhut. कोला *kola* also obtains in Shahabad and the south-east. In Sāran and Patna it is खण्ड *khund* or खंड *khānr* (which properly means a ruined house), and in Gaya घेवारी *ghewāri*. Other optional names are गल्ली *galli* in South Bhagalpur and कोनासी *konāsi* in Shahabad. When the fields of one proprietor's share are scattered over a village, each is called तख्ता *takhta* or किता *kitta*. The whole cultivation of such a proprietor is called खेती बारी *kheti bāri* to the west and in Tirhut; also खेत बहार *khet badhār* in Shahabad and Patna, and खेत पचार *khet pathār* in Champāran and South Munger. In Patna and Gaya खन्ध *khandh*, खन्धा *khandha*, किता *kitta* or किता *kita*, is a large area of cultivated land. A division of this is खण्डौट *khandhaut*, which is again divided into fields.

CHAPTER III.—BOUNDARIES.

833. The low ridge which forms the boundary of a field is everywhere आर *ār*, आरि or आरी *āri*, as in the proverb आरि जाई तः कपार लाठी, बीच बङ्गा चरवाही, *āri jāi ta kapār lāthi, bich banga charvāhi*,—if you go on a field boundary have a stick (to protect) your head, (and then) you may graze your cattle in the midst of a cotton-field. North of the Ganges it is also called डंडेर *danrer*. Other names are अहरी *ahri* (see § 919), अलङ्ग *alang*, or पराँठ *parānth* in Patna, Gaya, and the south-west; पारंगा *panrga*, गंडारी *ganrāri*, आरल *āil*, or आल *āl* in Gaya and South Munger, and डाँड *dānr* in South-West Shahabad. A ditch boundary is खड़े *khāi*, खार *khāi*, खत्ता *khatta*, or खावँ *khāwān*. Another name is खन्ता *khanta* in South Bhagalpur. In Gaya district डोभरा *dobhra* is a small ditch. An embankment used as a boundary is अहरा *ahra* (see § 919) or बाँध *bāndh*. Other names are भरबन *bharban* (Champāran), धूर *dhūr* (North Tirhut), and चरकी *charkī* (South-East Tirhut). A place where three boundaries meet is तिनकोनिया *tinkoniya*, and where four meet चौमुख *chaumukh*, चौबटिया *chaubatiya*, or चौराहा *chaurāha*. In Champāran and South-East Tirhut it is also चौपड़ *chāpड़*.

834. The rural Bihari lays great stress on the importance of keeping these boundary embankments in order. Thus, there is a proverb ठारिक चुकल बानर; आरिक चुकल बिधान *thārik chukal bānar, ārik chukal kisān*,—a cultivator who neglects to look after his boundary embankments becomes like a monkey fallen from a branch. Another

proverb which may be noted here is खेत भाड़े, चारि कोड़ी *khet bhāse ari kori*,—the field is flooded, out the boundary embankments, i.e., passion must have its vent.

CHAPTER IV.—FURROWS.

835. A furrow is चारर *harāi* to the west. In Champaran and Tirhut it is सिराउर *sirāur*, in Patna सिरोर *siror*, and elsewhere सिरौर *siraur*. In Gaya another name is सेवान *sewāt*. झंझिया *jhanjhiya* or चारी *dhāri* in Gaya and Sāran, and घरे *ghat* in Patna and South-East Tirhut, are the deep furrows in a field in which extra crops are grown, especially those at the edge of the field, or running from corner to corner.

836. The deep furrow used as an irrigation channel is चारा *āra* in the north-west, पैन *pain* or पैनि *paini* generally, दौंगर *daungar* in South Tirhut, Patna, and Gaya, नारी *nāri* or करन्हा *karha* to the west and in Patna and Gaya, भीता *bhita* in East Tirhut, and दौंग *daug* in Patna and to the south-east.

CHAPTER V.—MISCELLANEOUS TERMS USED IN CONNECTION WITH PLOUGHING.

837. To the west सँजवे *sānjh le*, सँझिया *sanjhiya*, and सँजहरिया *sanjhariya* mean 'up to evening,' or 'at evening' and hence are used as adjectives with the word जोत *jot* to signify as much land as can be ploughed in a day. In Champaran and South Munger this is सगरदिना *sagardina*, and in Patna ठकहरिया *thakhariya*. The area ploughed in half a day is called दोपहरिया *dopahariya*.

838. The portion of land included in a plough circuit is चाँतर *āntar*, and also to the north-west and in North-East Tirhut हडा *hattha*, and to commence another circuit is दोसर चाँतर चरब *dosar āntar dharab*. The place where ploughing is going on is चरवाही *harwāhi* in Patna and north of the Ganges. In Shahabad it is चरवाँही *harwāñhi*. In Patna it is टोपरा *topra*, and generally चराठा *harāṭha*.

839. The first ploughing of the season is चरमहतर *harmahutar* in Sāran and चरमोहतर *harmohtar* in Patna and Gaya. It is also समहतर *samhut*, and to the north सिरपंचमी *sirpanchmi* or सिरपचरै *sirpacharai*, both the last two terms being derived from the festival of the *sri*

panchami. In South Munger it is *हर महन्तर har mahantar* or *हर समत har samat*, and in South Bhagalpur *सोमता somāta*. Another name current in Sāran is *हरवत harvat*.

840. The bringing home the plough on the back of a bullock or with the share over the shoulder is *हरकुली harkhuli*, *हरकोलिया harkholiya*, or *हरकुजल harkhūjal*, and in South-East Tirhut (optionally) *हरकुगानी harkhugāni*. In South-West Shahabad it is *हरकुटाव harchhutāo*, and in the rest of the district and in Gaya *हरकुट्टन harchhuttan*. In Patna it is *हरबिनार harbinār* or *हरकोषार harjoār*, in South Munger and Champāran *हरकोलानी harkholāni*, and in Gaya, Champāran, and the South-East *हरकोली harkholi*.

841. The bullocks which draw a plough or harrow are called *बरद barad*, and to the west also *बैल bail*. When it is wished to distinguish them specially from cart-bullocks, they are called in Champāran and Tirhut *बडा बरद hattha barad*, and to the north-west and in Gaya *बरेडा बैल hareā bail*. A lazy fat plough bullock, which sits down rather than work, is called *कोढ़ि korhi* or *पवसा parua*, as in the proverb *कोढ़ि बरद केँ पेषरि बहत korhi barad keñ phephari bahut*,—it's the lazy bullock that puffs and blows.

CHAPTER VI.—PLOUGHMEN AND AGRICULTURAL LABOURERS GENERALLY.

842. A ploughman is *हरवाहा harwāha*, and to the west also *हरवाह harwāh*. In East Tirhut he is also called *हरौरी harauri*. His wages are called *हरवाही harwāhi*. An agricultural servant in general is *मजुरा majūra* or *बनिहार banihār*. An agricultural servant engaged for the whole year is *हरवर harvar* in Sāran and *भरसलिया bharsaliya* in North-East Tirhut, and one for the whole day is *भरदीना bhardina*. A ploughman who works for half a day is *दुपहरिया dupahariya* or *दोपहरिया dopahariya*, or in North-West Tirhut *पहरवार paharwār*. One who works on advances is *अगवड़* or *अगवड़ जन agvar (ōr agvarh) jan* to the north-west, *कमानर kamār* to the west, *कमियाई kamiyaī* or *कमियाँ kamiyān* in Patna, Gaya, and South Munger, and *लगुजा जन lagua jan* generally. The last is usually the man who binds himself to work off a debt incurred. When a ploughman receives the use of a plough for one day in three instead of wages in cash or kind, he is called *अंगवरिया angwariya* or *अगवरिया agwariya*, and to the west *अंगवार angwār*. In Sāran

and Champaran he is also called **तेपन्डा** *tepta* (so also in North-East Tirhut), or **तिररी** *tisri* or **तिररिया** *tisariya*. In East Tirhut a ploughman who works without advances is called **उत्था** *uttha*, as distinguished from **हरवाहा** *harwaha* or **हरौरी** *harauri*, who does take them.

843. In North-East Tirhut **पट** *pat* or **साटी पाटी** *sāti pāti* is the custom of a plough-owner employing two ploughmen for each plough, each ploughman relieving the other at intervals of eight days. In Shahabad and Patna **हरार** *harāi* is the custom under which every tenant lends his plough and bullocks to the landlord for two days in the year.

844. An agricultural labourer paid in kind is **जन** *jan*, also in Gaya and Champaran **उफंगिया** *uphangiya*, and in South-West Shahabad **बनी** *bani*. One who receives money is **नोकर** *nokar*, or in the north-west **जाना** *jāna*. One paid solely in cash is called **कोरजा** *koranja* to the north-west. In Patna, Gaya, and South Munger the prædial slaves who are attached to an estate, and cannot leave it, or marry, or in fact do anything without the consent of their landlords, are called **नफर** *naphar* or **कमियाँ** *kamiyān*; and food given to such is **खैरान** *khaihan*. A labourer who by custom works a certain number of days for nothing for Government (formerly, and for the landlord nowadays) is called **बेगार** *begār*. Payments made in kind to agricultural labourers are called **बन** *ban*, or in East Tirhut **बोन** *bon*. Advances to ploughmen are **अगवद** *agwar* in the west and **अगौरी** *agauri* in South-West Tirhut. Elsewhere in Tirhut and to the north-west they are called **हरौरी** *harauri*, and generally **लगुवा** *lagua*.

845. When there are spare bullocks in a field where ploughing is going on to relieve those that get tired, the boy who looks after them is called **अनवाह** *anwāh* in East Tirhut; elsewhere he is **चरवाहा** *charwaha* or **गोरखिया** *gorkhiya*.

CHAPTER VII.—RECIPROCAL ASSISTANCE IN CULTIVATION.

846. **बदलैया** *badlaiya* and **पल्ला** *palla* or **पल्लो** *palli* are terms for exchange of labour for labour by agriculturists. To the west it is also called **पैच** *painch*, in Gaya **बदली** *badli*, and to the south generally **पापठ** *pāṭh*. In East Tirhut another name is **जानपैचा** *janpaincha*. The practice of two or more cultivators joining their

ploughs and ploughing together, first the field of one and then the field of another, is called generally भँज *bhānj*. Other names are भँजहरिया *bhānjhariya* and हर सज्जा *har sajjha* to the west generally भजौती *bhānjauti* in North-East Tirhut, हर भज्जा *har bhānja* in Patna and to the north, हर पख्ता *har pahta* in Champāran and Gaya, भँजैठ *bhānjeth* in South-East Bihār, and भँजो *bhāngo* in South Bhagalpur. The cultivator in this case is भँजा वाला *bhānjā wāla*, or in Tirhut भँजैत *bhānjait*. Another name current to the west is अँगवारा *angwāra*, though this properly refers to the custom of paying ploughmen (अँगवहरिया *angwariya*, see last chapter) by lending them a plough and cattle one day in three.

847. The work which one cultivator does for another in this way is called to the west सापठ *sāpat*.

SUBDIVISION II.

MANURING.

CHAPTER I.—KINDS OF MANURE.

848. Manure is north of the Ganges खादर *khādar*, खदौड़ *khadaur*, खड़ी *khaddhi*, or गोंदौरा *gondaura* to the west, and गोषा *goa* or करन्गी *karsi* to the east. South of the Ganges, to the west, it is घूर *ghūr*, and to the east (also in Sāran) गनौरा *ganaura* or गंदौरा *gandaura*. कूड़ा *kūra*, कूड़ा कुरकुट *kūra kurkut*, बहारन *bahāran*, or (in South-East Tirhut) गोनरौर *gonraur*, is rubbish or road-sweepings. Cowdung is गोबर *gobar*. When dried it is called south of the Ganges दमारा *damāra*, of which a variant in East Tirhut is दमार *damār*, also in Shahabad and Patna कण्डा *kanda*, and to the west कँडरा *kanrra*. The latter term is also used in Sāran. In North-East Tirhut it is गौठि *gauthi*, and in Champāran गौठी *gauthi*. In Gaya फँटी *phenti* are pieces of dried cowdung. चोट *chot* to the west is the quantity that falls from an animal at one evacuation. Cattle urine is गौन *gaunt* or गौत *gaut*, and to the west also मूत *mūt*. लौद *lūd*, लिदी *liddi*, or लोदी *lōdi* is the dung of horses, elephants, &c., and that of sheep or goats is भँडाड़ी *bhenrāri*, भेनाड़ी *bhenāri*, or (to the west) लेंरी *lenri*. Other filth of various kinds is मैला *maila*, or in South Bhagalpur गिना *ghina*. The refuse of indigo after maceration used as manure is सीठ *sith*.

849. A manure heap near a house is *धेरी dheri*, or (in East Tirhut) *गोनर gonar*.* North of the Ganges generally it is also *मान mán*. A manure-pit is *घूर ghūr*, *खाद khād*, or *खाद के मड़गा khādar ke garha*. A heap of dried grass, sweepings, dung, &c., is in North-East Tirhut and Shahabad *कूर kūr*. Ashes are *राख rākh* or *खाडर chhāūr*, and in South Bhagalpur *चौरो chhaurō*. In Patna and Gaya they are *बानी bāni*. An ash-heap is in North-East Tirhut *चौराठ chhaurāth*.

CHAPTER II.—MODES OF MANURING.

850. Heavily-manured land is north of the Ganges *खदौर खेत khadaur khet*, or it is called *गोबन्दा गobrāēl*, or in South-East Tirhut *भरल bharal*. South of the Ganges it is *खदौर khadaur*, *खदगौर khadgaur*, or *खरित kharit* in Shahabad.

851. The custom of allowing cattle to stand in a field for the purpose of manuring it is called north of the Ganges *भेंड़ी बैसाबोल bhenri baisāōl* or *भेंड़ी खिराबोल bhenri hirāōl*; south of the Ganges it is *जिवनर होरा हा घूर बैसाबोल jivgar hoē la dhūr baisāōl*, and in South Munger they say *खेत गोबन्दा खेत khet gobrābe heñ*.

CHAPTER III.—MANURE USED AS FUEL.

852. Manure collected in the forests and grazing-grounds and dried for fuel is called north of the Ganges *कंदगा kanra* or *करगा karra*. South of the Ganges it is *डमारा damāra* or *कप्पा kanda*. In East Tirhut it is *डमार damār*, and to the west it is also called *बिनुवा गोरठा binua goītha*. Another general name is *बन गोरठा ban goītha*. When made up into cakes with chaff and other refuse, the large oblong blocks are called *गोहरा gohra* to the west and *गोरठा gorha* in Champaran and to the east. The next sized round cakes which are stuck on the wall to dry are *गोइठा goītha* or *गोरठा goītha*. The smallest cakes are *चिपरी chipri*. The largest-sized slabs made with both hands are *दोहथा dohtha* or *सोथथी soththi*. *करसी karsi*, or in Gaya and South Munger *अमारी amāri*,

* Compare for an example of this word the proverb *गोघारक गोनर दुहु दिव सिक्कन goārak gonar duhu dis chikkan*,—a gowāla's dunghill is neat on both sides.

are unmanufactured lumps of dry cowdung dried and stored.

853. The pile of cowdung fuel is called to the west गोहरौर *gohraur* or गोहरौरा *gohraura*. In North-East Tirhut it is गोडौर *gothaur*, in Champāran गोडौला *gothāula*, and there and in Tirhut टाल *tāl*. It is छुआ *chhūa* optionally to the west, छुआ *chhūa* or छुआ *chhūhi* in Patna and Gaya छुआ चन्ना *chhūa chhanna* in South Munger, and छानी *chhāni* in South Bhagalpur. The pile of the large oblong blocks is also called गोहरा *gohra* or गोरहा *gorha* as above. The house in which the fuel is stored is गोडौर *gothaur*, गोडौरा *gothaura*, or गोडौल *gothaul* generally; also गोडुल *gothul* in North-East Tirhut, गोडुल *gothāhul* in Shahabad, and गोडुठा घर *goṭha ghar* in Gaya. The operation of making the cakes is पाथब *pāthab* or पाथल *pāthal*, according to locality, or else थोकब *thokab* or थोकल *thokal*. The place where they are made is north of the Ganges generally पथारी *pathāri*. South of the Ganges it is पथरौर *pathraur* in the west, आड़ा *āra* in Gaya, and पानर *pānrrar* in Patna.

854. In selling cowdung fuel a पन *pan* equals 20, 22, or 23 गन्दा *ganda* (i.e. fours), according to locality. In buying the article in Patna the seller gives two cakes extra (called a पनकी *panki*) for every पन *pan* bought.

SUBDIVISION III.

SOWING AND TRANSPLANTING.

CHAPTER I.—SOWING.

855. *Sowing* is to the west बोषनी *boñni*, and to the east बावग *bāwag*, बाषोग *bāög*, or बाउग *bāüg*. South of the Ganges, and also in Champāran, it is also बोषा *boāi*, or in Patna and South Munger बोनी *boni*. In South Bhagalpur (and also in Champāran) the word is बोषनी *boñni*. To sow is north of the Ganges, बोषल *boāl*, बावग करब *bāwag karab*, बूनब *būnab*, or बूनल *būnal*, according to locality. To scatter the seed is generally छिटब *chhitab* or छींटब *chhintab*. In Patna चुलाएब *chulāēb* is also used in connection with *Bhadoi* or autumn crops.

856. *Seed* is बीया *biya* or बीहन *bihan*. In Gaya it is बिहन्ना *bihnāi* (also used in Champāran), बिच्चा *bichcha*, or गोटा *gota*, and in South Bhagalpur बिन्हा *binhāi*. A grain of seed is दाना *dāna*.

Barren seeds are चबौ *abbi* (or in Shahabad) चबई *awai*, and fertile seeds are सुग्गी *suggi*.

CHAPTER II.—MÔDES OF SOWING.

857. The following are the modes of sowing:—

- (a) *Furrow sowing.*—चारी *dhâri* or चरिया *dhariya*. To plough in this way is चारी लगान *dhâri lagâëb* or चरिया लगान *dhariyâëb*. South of the Ganges this method is called चुटकी *chutki*. In this method a plough goes in advance of the sower, who carries the seed in a basket. He drops it into the furrow as soon as the latter becomes visible. By this method the seed is sown deep, the stalk is stronger, and not so liable to be laid by high winds. मटाण *bha/hâëb*, दोचरिया *dodhariya*, दोहार *dohâr*, or समार *samâr* is the practice of filling up with soil the furrow in which the seed has been sown, by ploughing a separate furrow beside it. This is generally done in the case of *Bhadoï* crops. Sugar-cane is not covered in this way in Bihâr, but by hand. The long straight lines of seed across a field are known as चारी *dhâri* or पाँती *pânti*. When the ploughing is done round a field, and not across, it is called चौकैठा *chauketha*, &c. (See § 828).
- (b) *Sowing by drill.*—This is टार *târ*, टारी *târi*, टोर *tor*, टोरी *tori*, often spelt टॉर, टॉइ *tânrr*, टॉर, टॉइ *tonrr*, &c. To sow in this way is टारण *târâb* or टोर लगान *tor lagâëb*. The man who works the drill-plough is टारवाह *tarwâh* or टोरवाह *torwâh*.
- (c) *Broadcast sowing.*—This is generally बाबन *bâwag* or its variants,—see above. Other names are चिह्ता *chhitta* or चिह्ता *chhitua* north of the Ganges, and चिह्ता *chhînta* south of it. Maize and similar crops are sometimes sown broadcast on land left soft after an inundation, and are then pressed into the mud by hand. This method of sowing is called डोभा *dobha*, and to sow thus is डोभा *dobhab*.

858. If the seed is sown on lands which have not been ploughed, it is called चिहा *chhitta*, चिहवा *chhitua*, or south of the Ganges जंगली बावर *jangli bāwag*, पैरा *paira* (Gaya, also in Champāran), or पापर *pāer* or समार *samār* (Patna and South Munger). चोंटा *chhāntā* or चिहा *chhitta* is also used to signify lands in which the seed has been scattered after a single ploughing. It is also specially used for sowing the spring (रबी *rabi*) crops on the दोफसिला *dophasila* lands, *i.e.*, those from which the autumn crop has just been cut, as contrasted with the पलिहार *palihar* or चौसाच *chaumās*, which are carefully-prepared fallow lands for wheat and similar crops. The sowing of the early rice in dry lands is खरहर बावग *kharhar bāwag*. North of the Ganges it is also धुरिया बावग *dhuriya bāwag*. South of the Ganges it is in Shahabad and Patna ठररा *tharra*, in the rest of the district खरवाह *kharwāh*, in Gaya खरवेह *kharweh* or खरवे *kharwe*, in Patna बाघा *baugha*, and in South Munger धुरघुसा *dhurghussa*. In Patna and Gaya sowing in a wet field is called लेवा *lewa*. Sowing wide apart is generally पातर *pātar*. Other names are (north of the Ganges) फकाह *phakāh* or फांफर *phānphar* to the west and हेहर *chhehar* or पेरमार *permār* generally. South of the Ganges we find पाथर *pāthar* in Gaya, पतला *patla* in South Munger, and पतील *patil* in South Bhagalpur, the last two being also met with in Champāran. Sowing thick is generally घन *ghan*, गाढ़ *gārh*, or गाढ़ा *gārha*. North of the Ganges सजोर *sajor* is used in the same sense.

859. Grain that fails to germinate is अब्बी *abbi*, निरबीज *nirbij*, बिजमार *bijmār*, or बीया मार *biya mār*. In South-West Shahabad it is बरुवा *barua*. If a man wishes to say that his seeds have not come up, he says हमार बिजमार मारल गेल *hammar bihnāi mārāl gel*.

860. When from excess of rain followed by heat a crust is formed on the surface, which prevents the young plant from coming up, it is called to the west सपट जारल *sapat jāil* or सपटा जारल *sapta jāil*. In East Tirhut and Shahabad it is called सपरी *papri*. South of the Ganges it is तावा *tāwa* to the south-west of Shahabad, or सेवठा *sewtha* in the rest of the district and in Patna. Elsewhere it is सेवठा *sewta* or मुन्दा *munda*.

861. *Self-sown seed*.—Seed which falls on the ground in the field at harvest time, and which germinates next year, is called लमेरा *lamera* in the west, नन्हेरो *namhero* in South Bhagalpur, and नन्हेर *namher*, लमेर *lamher*, or लाम *lām* in South Munger.

CHAPTER III.—SEED-BEDS AND NURSERIES.

862. A nursery for rice is बिड़ार *birār* or बियार *biyār*. To the west it is also बेंगा *benga*. The young plants which are transplanted from the nursery are generally बीया *biya* or गाछी *gāchhi*. They are also called बीहन *bihan* or बीहनार *bihnāi*. South of the Ganges and to the north-west (when of rice) they are also called मोरी *mōri*, and in Champāran जरई *jarai*. The bundles of rice seedlings ready for transplanting are चाँडो *ānti* or अँटिया *antiya*.

CHAPTER IV.—SOWING TIME.

863. The sowing season is बोखनी *boñni* north of the Ganges and बोग्घा *bogha* south of it. It is also generally called बावग *bāwag*.

CHAPTER V.—TRANSPLANTING.

864. To transplant is रोपव *ropab*. In Gaya when a man has finished transplanting he says हम्मर बनुसार भेल *hammar banusār bhel*,—‘I have finished transplanting,’ the quantity of rice seedlings transplanted at one place being called everywhere except in the south-east बान *bān*. A bundle of seedlings is चाँटी *ānti*, and the man who plants them is called डोभा *dobha* or रोप-निहार *ropnihār*. The bundles are tied in pairs and set astride over a long bamboo when carried about. This bamboo is called to the west बिहन्डोवा *bihandhoa* or कनाठ *kanāth*. The man who roots up the seedlings from the seed-bed is called कबरिया *kabariya*, or in Sāran कबरिहा *kabariha*. In South Munger he is also called मोरकबरा *morkabra*. Seedlings which have been re-transplanted, *i.e.*, transplanted more than once, are called north of the Ganges खार *khāru* or खरहन *kharuhan*.

SUBDIVISION IV.

DIGGING, HOEING, AND WEEDING.

CHAPTER I.—DIGGING.

865. To dig is कोदव *kōrab*. In Champāran and Tirhut it is also तामव *tāmab* or पारव *pārab*. In South-West Shahabad it is देलव

chhejal. Digging is कोड़नी *korni*, also in Champāran and Tirhut तमनी *tamni*, in Patna, Gaya, and South Munger निकौनी *nikauni*, and in South-West Shahabad हजेनी *chhejni*. In South Bhagalpur it is कोड़न *koran* or खँड़ *khanr*. In Saran and Champāran गोहट *gohat* is digging or hoeing the edges of fields. In Tirhut this is called आरि हाँटव *ari chhāntav*.

CHAPTER II.—HOEING.

866. Hoeing is खुरपियाना *khurpiyāna* to the north-west. In Champāran and in Tirhut generally it is केरौनी *kerāuni* or कामैनी *kamaini*. South of the Ganges it is कोड़नी *korni*, or in South-West Shahabad हजेनी *chhejni*. In the month of *Asārhi* (June-July) sugar-cane gets a special hoeing, which is called असाही कोर *asārhi kor*, and in Champāran and North-East Tirhut टोकव *tokav*. In Gaya it is called पासा *pāsa*, and in Patna असाही कोड़न *asārhi koran*. In Champāran and the south-east it is अद्रा कोरन *adra koran*, and elsewhere it has no special name. The first hoeing of the sugar-cane crop, which generally takes place in Māgh (January-February), is called अंधेरी कोरन *andheri koran* in Patna, चालन *chālan* or उभलन *ujhlan* in Gaya and to the west, अंधेरी *andheri* or भाड़नी *jhārni* in Saran and South Munger, and जुरनी *jhurni* in South Bhagalpur. North of the Ganges it has no special name.

CHAPTER III.—WEEDING.

867. Weeding is केरौनी *kerāuni* or कामैनी *kamaini* north of the Ganges. In the west generally it is सोहनी *sohni*. Elsewhere it is generally कोड़नी *korni*, and also हरखी *harkhi* in Patna and उभलन *ujhlan* in Gaya and Shahabad. In South Bhagalpur it is optionally केलौनी *kelauni*, and केरौनी *kerāuni* reappears again in South Munger. To weed deep is भर खुरपी सोहव *bhar khurpi sohab*; also कोड़ देव *kor deb* to the north-west and in North-West Tirhut, and खामल *khābhal* in Saran and Champāran. In Patna the operation is called बिसमादी *bismādi*, and elsewhere it has no special name. Superficial weeding is खुरपियाना *khurpiyāna* in the north-west and निकौवन *nikāwan* in the south-east. In Champāran and Tirhut it is called टिपनी *tipni*. The digging up a field to clear it of weeds before ploughing is तामव *tāmav*, also in North-East Tirhut टोकव *tokav*. The operation is called तमनी *tamni*, or in North-East Tirhut टोकनी *tokni*.

Weeding by hand is चिखुरन्नी *chikhurni* in the north-west and उच्छतनी *uchhtani* in Champāran and Tirhut. In Patna, Gaya, and South Munger it is हाँथ सेँ निकारब *hānth señ nikāēb*, and in South Bhagalpur थकुररै *thakurāi*. In Shahabad it has no special name.

868. Weeds are घास *ghās* or घास पान *ghās pāt*. In the north-west they are also दूभ दाँदर *dūbh dāndar*, and in Tirhut दू *dhū*. When collected and burnt as manure, they are खादर *khādar* in the north-west, and गोसा *goa* there and in Tirhut. In Patna and Gaya these are अलाह *alāh* or डाही *dāhi*, हूरा *hūra* in South Munger, and हारो *chhāro* in South Bhagalpur.

869. Wages for weeding are सोहार *sohāi* or चिखुरार *chikhurāi* in north-west, and in the east generally simply बन *ban*. In Patna and Gaya they are निकौनी *nikāuni*, in South-West Shahabad बनी *bani*, and to the west generally बनिहारी *banihāri*.

SUBDIVISION V.

WATCHING CROPS.

870. Watching of crops is generally रखवारी *rakhwāri*, अगोरी *agori*, or अगोरिया *agoriya*. Other terms are रखवाही *rakhwāhi* or बलरखी *balrakkhi* in Patna, जगवारी *jagwāri* or बधवाहा *badhwāha* in Gaya, बधवार *badhwār* in East Tirhut, and जोगाब *jogāeb* in Champāran and South Bhagalpur. In Champāran and the south-east हाँकी *hānki* is to drive crows off a field. Elsewhere it is कौसा हाँकब *kāua hānkab*, &c. A field-watchman is रखवार *rakhwār*, अगोरिया *agoriya*, or अगोरनिहार *agornihār*; also बलरखी *balrakkha* in Patna, अगोरा *agora* there and in Champāran and South Munger, जगवरिया *jagwariya* in Gaya, and जोगानियाँ *joganiyān* in South Bhagalpur. The बधवार *badhwār* or बधवाहा *badhwāha* is generally a man appointed to watch the fields of a number of cultivators and paid by the landlord.

871. In the north-west चँकनिहार *chhenknihār*, and in North-East Tirhut चकलेदा *chakledār*, is a man appointed to watch on behalf of the landlord to see that none of the crops is carried away before the demand is paid. Elsewhere he is simply called पियादा *piyāda* or बरहिह *barāhil*, but to the south-east he is सिरमान *sirmān* or बलरखी *balrakkha*. To attach the crops thus is called रोकब *rokab*: hence the

Anglo-Indian phrase "to roke crops." The act of "roking" is called in the north-west चापा *chhāpa*.

872. When cultivators club together to watch their crops in turn, it is called north of the Ganges पारी *pāri*, भाँज *bhānj*, or भाँजा *bhānja*. It is also पल्लडी *palti* in Patna, Gaya, and the west; also परिवार *parihar* in Patna and Gaya, पेठी *pethi* in South-West Shahabad, and पाठ *pāṭh* in South Munger.

SUBDIVISION VI.

REAPING AND GLEANING.

CHAPTER I.—REAPING.

873. Reaping is कटनी *katni*, or to the north-west कटिया *katiya*. In South-West Shahabad it is लौनी *launi*. To reap is काटब *kātab*, or in South-West Shahabad लौनी करल *launi karal*. To cut cane is झोलल *chholal* in the north-west, गेंडा करल *genra karal* to the west, पारब *pārab* in Champāran and Patna and Gaya and South Munger, and घूर काटब *ghūr kātab* in South Bhagalpur.

874. The man who cuts the cane is described in section 292. A reaper is कटनिहार *katnihār* north of the Ganges and in Patna and to the south-west. He is also दिनिहार *dimihar* in Patna, Gaya, and South Munger, लेवनिहार *leonihār* or कटनियँ *katniyān* to the west. Elsewhere he is simply जन *jan*, बनिहार *banihār*, &c. Harvest time is कटनी *katni*. The wages of harvesting are दिनौरा *dinaura* in Patna and Gaya, and दीनी *dīni* in Champāran, Gaya, and the south-east. Another name is in Gaya गुदारा *gudāra*, or in Sāran गुदर *gudār*. Elsewhere they are बन *ban*, or in South-West Shahabad बनी *bani*.

875. Cutting the ears without the stalks is बलकट *balkat* generally. Other names are टुंगनी *tungni* north of the Ganges and to the west, अगला *agla* in Champāran and Gaya, कट्टर *katū* in South-West Shahabad, पाँगल *pāngal* to the west, and नन्हकटनी *nanhkatni* in South Munger. So also in East Tirhut it is नन्हकटनी *nankatni* or (also in Champāran) सिसकटनी *siskatni*, and in South-East Tirhut चिपकटा *chhipkatta*. It is अगला *agra* in South Bhagalpur. Cutting crops at the root is जरन्होरनी *jarchhorni*, (in South-East Tirhut) जरकटा *jarkatta*, or (in South Munger) जरन्होरा *jarchhora*.

876. To shake the fruit off a tree is *अरुअरारुल jhārjharāēl* in the north-west. In Champāran and West Tirhut it is *अरुअरारुल jharkhāēb*, and in East Tirhut *अरुअरारुल jhakāēb*. To the west it is *अरुअरारुल jhoral*, and also, generally, *दोलब dolab* or *दोलाय देब dōlay deb*. *अरुअरारुल jhatahab* is to knock down fruit from a tree by throwing up sticks into it (see § 41).

CHAPTER II.—CUTTING OF UNRIPE CROPS.

877. Unripe crops are sometimes cut for food. North of the Ganges this is known as *गदरा gadra* or *कच्चा kachcha*. Other names are *गादा gāda* and *गदा gadda*. In South Munger it is *गादर gādar*, and in South Bhagalpur *अंकुरी ankuri*. The last two are also met with in Champāran. A word used to the east generally is *कचरी kachri*. In the north-west *समकत samakut* is a little grain cut first, and this is *सुमुत sumut* in North-West Tirhut, *नेवान newān* in Sāran, and *नेवान nebān* in Champāran and Tirhut. *खोरहा horha* is unripe grain cut for parching. It is also called *खोरहा orha* in Tirhut and the south-east, and optionally *खोलहा holha* in Champāran and South Munger. The green ears of *Eleusine coracana* (*महुआ marua*) treated in this way are called *उम्मी ummi* or *उमी ūmi* to the west and in Tirhut and *उनी ūni* in Champāran. *आलो ālo* in Gaya is the part of the crop which is reaped by a cultivator for present eating before the whole is ripe. Sometimes unripe pulses and barley are rooted up and given as fodder to cattle. This is called in Sāran *रखत rakhāt*.

CHAPTER III.—GLEANNING.

878. A gleaner is *बिन्नहार binnihār* or *बिनीयँ biniyān* to the west. He is also generally *खोडगहार lorhnihār*, with variants *खोडगहार lorhtāhar* in Patna, Gaya, and South Munger, and *खोडगहार lohra* in South Bhagalpur. Gleanings left on the field for the lower orders are *अरुंग जहारnga* or *अरुंग जहारng* to the west, and *खोड़ी lorhi* or *खोड़िया lorhiya* to the east and in Champāran. Other names are *अरुआ jharua* (Patna and North-West Tirhut), *अरु jhar* (South-East Tirhut), and *छटल पटल chhūtal patal* (Champāran and Tirhut). Gleaning is called in Gaya and South Munger *खोड़ा बिचा lorha bicheha*, and gleanings are *खोड़ा lorha*.

SUBDIVISION VII.

THRESHING AND WINNOWER.

CHAPTER I.—THE THRESHING-FLOOR.

879. A threshing-floor is everywhere खरिहान *kharihān*, with an optional variant खरिहानी *kharihāni* in Patna. The shed erected on the threshing-floor is मड़रै *marai*, खोंपड़ी *khompri*, or झोंपड़ी *jhompri*. In Patna it is मरुका *maruka* or झोंपड़ा *jhompri*, in Gaya कूहा *kūrha*, and in the south-east खोंपड़ा *khompri*.

CHAPTER II.—SHEAVES AND BUNDLES.

880. The cut crop is डाँठ *dānth* to the north-west, or दाँठ *dānt* in North-West Tirhut. In East Tirhut it is लार *lār*. In Shahabad it is लेहनी *lehni*, in Champāran लेहन *lehan*, in Gaya पतौर *pataur*, in Patna पतौड़ी *patauri* or पतनी *patni*, in South Munger पातन *pātan*, and in South Bhagalpur पतन *pattan*. In Shahabad it is called पल्हा *pathāri*, and in Sāran पथारी *pathāri*, when it is left a day in the field without being gathered.

881. In considering the nomenclature of the sheaves it will be convenient to take North and South Bihar separately.

NORTH BIHAR.

882. The smallest sheaf, about a handful, is called मूठा *mūtha*, मुठा *muttha*, or पूला *pūla*; the next largest is the अँवाँसा *anwānsa* (north-west), औल्हा *aulha* (North Tirhut), and आडल *āhul* or अडला *ahula* (East Tirhut); the next largest is the अँटिया *antiya* or (Champāran and North-West Tirhut) पसही *pasahi*; the next largest is an armful or पाँजा *pānja*; the next largest is a बोझा *bojha*; and the largest of all, that carried on a bullock, लदना *ladna*. The relative scale of some of the above is generally as follows:—

4 मूठा <i>mūtha</i>	= 1 अँवाँसा <i>anwānsa</i> or औल्हा <i>aulha</i> .
8 औल्हा <i>aulha</i>	= 1 पाँजा <i>pānja</i> .
4 पाँजा <i>pānja</i>	= 1 बोझा <i>bojha</i> .
16 बोझा <i>bojha</i>	= 1 सोरही <i>sorhi</i> .

In East Tirhut the following scale obtains :—

- 4 चाडल *āhul* = 1 केडनी *kehuni*.
 4 केडनी *kehuni* = 1 पाँजा *pānja*.
 4 पाँजा *pānja* = 1 बोभा *bojha*.
 16 बोभा *bojha* = 1 सोरही *sorhi*.
 16 सोरही *sorhi* = 1 सोरहा *sorha*.

883. The word सोरही *sorhi* is a common unit for measuring produce. Thus, a *raiyat* will say that such and such a field gives so many सोरही *sorhi* to the *bigha*.

SOUTH BIHAR.

884. The proportions vary in different places, as follows :—

SOUTH-WEST SHAHABAD.

- 2 अँवाँसी *anwānsi* = 1 अँटिया *antiya* or दोमङ्गा *domra*.
 10 ditto = 1 पाँजा *pānja*, पूरी *pūri*, or आँटी *ānti*.
 3 पाँजा *pānja*, पूरी *pūri*, or आँटी *ānti* = 1 बोभा *bojha*.
 30 ditto ditto = 1 तिसौर *tisaur*.

SHAHABAD.

- 10 अँवाँसी *anwānsi* = 1 अँटिया *antiya* or पनगपिआँसा *panpiāua*.
 4 अँटिया *antiya* = 1 बोभा *bojha*.
 Or 10 आँसी *ānsi* = 1 पाँजा *pānja*.
 4 पाँजा *pānja* = 1 बोभा *bojha*.
 21 बोभा *bojha* = 1 एकैसिया *ekaisiya*.

PATNA.

- 4 अरपा *arpa* = 1 आँटी *ānti*.
 5 आँटी *ānti* = 1 गाही *gāhi*.
 5 गाही *gāhi* = 1 बोभा *bojha*.
 Or 5 अरपा *arpa* = 1 पाँजा *pānja*.
 5 पाँजा *pānja* = 1 बोभा *bojha*.
 21 बोभा *bojha* = 1 एकैसी *ekaisi*.

GAYA.

3 अरुपा <i>arpa</i>	= 1 आँटी <i>ānti</i> .
5 आँटी <i>ānti</i>	= 1 गाही <i>gāhi</i> .
10 गाही <i>gāhi</i>	= 1 बोझा <i>bojha</i> .
Or 9 अरुपा <i>arpa</i>	= 1 पाँजा <i>pānja</i> .
3 पाँजा <i>pānja</i>	= 1 बोझा <i>bojha</i> .
21 बोझा <i>bojha</i>	= 1 एकैसी <i>ekaisi</i> .

SOUTH MUNGER.

The same as Gaya, except that 4 पाँजा *pānja* = 1 बोझा *bojha*.

SOUTH BIHARALPUR.

4 गौंती <i>gaunti</i>	= 1 आँटी <i>ānti</i> .
4 आँटी <i>ānti</i>	= 1 पाँजा <i>pānjau</i> .
16 आँटी <i>ānti</i>	= 1 बोझा <i>bojha</i> .
16 बोझा <i>bojha</i>	= 1 सोरही <i>sorhi</i> .

885. The word एकैसी *ekaisi* south of the Ganges is used in much the same way that सोरही *sorhi* is used; so also तिसौर *tisaur*. It will be seen that the above scales are not always consistent amongst themselves. This is the fact, and is due to a difference in the size of the unit according to locality. The बोझा *bojha* is about the same everywhere.

886. An अक्वार *akwār* or अक्वार *ankwār* (optionally), or in Patna and South-East Tirhut केहुनी *kehuni*, is as much grain as can be carried between the arms, and मथःबोझा *mathbojha* is a load carried on the head. Out of each बोझा *bojha* one आँटी *ānti* is given to the labourer who cuts and carries away the crop, and the remainder is in Shahabad called गुदर *gudār*.* गुण्ड *gund* in Patna or गूंडा *gūnda* in Gaya is a bundle of cut pulse.

CHAPTER III.—TREADING OUT GRAIN.

887. Treading out grain is दौनी *dauni* north of the Ganges. To the west and in Patna it is also दौरी *daunri* or मिंजनी *minjni*. The latter word is principally used when the grain is trodden out by men and not

*The आँटी *ānti* given to, or rather taken by, the reaper varies in size, as is witnessed by the proverb कोढ़ि कटगिहार केँ सुन्नर सग आँटी *korhi katnihār keṅ mungar san ānti*,—the lazy reaper gets a bundle as thick as a club.

by bullocks. In Shahabad it is *दौरी dauri*, and so also in the south-east. In Champāran, Patna, Gaya, and South Munger it is *दावाँची dawānhi* and in Patna also (when trodden by men) *मँजनी mainjni*. In South Bhagalpur *सहरी sahari* is a thorough threshing of corn. The beating out of the heads against the ground or bed to disengage any grains that remain is *पीटब pūtab*, *भारब jhārab*, or *भाँटब jhāntab* north of the Ganges. It is also *पेटारी petāri* to the west, *डंगौनी dangauni* in Patna, *पिटनी pitni* in Champāran and Gaya, *डंगौनी dengauni* in East Tirhut and South Munger, and *भाँटनी jhantni* in South Bhagalpur.

888. The first treading out of the grain is called *पौर paur*, the second treading is *दन्ती दाँब danti dāmb* north of the Gange and in Shahabad, or *तोड़ाब torāb* in North-East Tirhut. To the west it is *भाँटब chhāntab*, in Champāran and Patna it is *खुरदाँनी khurdauni*, in Gaya *खुरदाँनी khurdanti*, and in South-East Tirhut and South Munger *खुरदाँनी khurdāni*.

889. The stake to which the bullocks are tied in treading out the grain is *मँह meñh*, with local variants *मँहा meñha* (to the north-west and in South-East Tirhut), *मेहटा mehta* (Patna), and *मीहाँ mīhān* (South Bhagalpur). In South-West Shahabad no centre stake is used. A bullock stands in the centre, who is called *मँहियाँ बैल meñhiyān bai*. In other places the inner bullock next the post, which is the slowest and weakest of the team, is called *मँहियाँ meñhiyān* generally; also *मँहा menrha* in Champāran and South-East Tirhut, and *मेहटा mehta* or *मँहटा menhta* in Gaya and South Munger. In South Munger he is also *मेहा meha*, and in South Bhagalpur *मीहाँ mīhān*. Another name for him is in Gaya *कुड़दहिना kurdahina*. The outer bullock, which is the smartest of the team, is called *पाठ pāth* or *पठिया pathiya* to the west to the north-west and in North-West Tirhut *पठिया pathiya*, and in East Tirhut *पाठ वाला pāt wāla*. In South-East Tirhut it is *अगदाँनी agdān*, and variants of this are *अगदाँनी agdān* in Patna and South Munger, *अगदाँनी agdān* or *अगदाँनी agdāniyān* in Gaya, and *अगदाँनी agdān* in South Bhagalpur. In South-West Tirhut he is *पेरा phera*. The rope which goes round a bullock's neck is *गरदाँनी gardāni* in the west and in South Munger, *गरदाँनी gardani* in Champāran and West Tirhut, and *गराँधा garaundha* in Patna. The main rope to which all the bullocks are tied is *मन्जा manjha*, also *दौरी dauri* to the west, *दौरर daunrar* or *दोगहा dogha* in West Tirhut, and *कराँ करām* in East Tirhut. In Patna, Gaya, and South Munger it is *दावाँची dawānhi*, and in South Bhagalpur *दाँमर dāmmar*. In



A threshing floor (kharikān) The man standing on the right of the picture holds in his right hand a threshing-rod (akhuina)

Champāran and Gaya it is also called काँड़ *kānr* or काँड़ा *kānra*. The rope by which the main rope is tied to the stake is घुरी *ghūri* or मेँहौटी *meñhauti* in Patna and Gaya, and डॉड़ा *donra* in South Bhagalpur.

CHAPTER IV.—CROPS ON THE THRESHING-FLOOR.

890. *The pile of sheaves.*—When the crop is piled in bundles on the threshing-floor it is known as गँज *gānj*. Other names are टाल *tāl* (north of the Ganges and Shahabad), गल्ला *galla* (North-West Bihār), डेरी *dheri* in Gaya, and काँड़ *kānr* or काँड़ा *kānra* in Champāran and to the east; also खम्हार *khamhār* in South-East Tirhut. When the cut crop is piled like a stack in England, with the grain heads inside to save them from rain, it is called कोठियो *kothiyau* in Sāran, and पूँज *pūñj* or पुँजौर *punjaur* to the north-west and in Patna, Gaya, and the south-east. When *rahar* (*cytisis cajan*) is piled on end to ripen before threshing, it is called खड़ा टाल *khara tāl* north of the Ganges. Stacks are rarely raised on platforms in Bihār, but when it is done the platform is called मचान *machān*.

891. *The spread-out crop.*—When the crop is spread out flat on the threshing-floor, ready to be trodden out by the bullocks, it is पैर *pair* north of the Ganges and in Shahabad. Other names are पौर *paur* or पौरी *pauri* in East Tirhut, खोह *khoh* in Champāran and South-East Tirhut, बड़बोरा *barhora* in Patna and Gaya, बड़बहरा *barhara* in South Munger, and खूषा *khūa* in South Bhagalpur.

892. *The crop after it is trodden.*—After the crop is trodden out the pile of chaff and grain ready for winnowing is सिल्ली *silli* north of the Ganges, in Patna, and the south-west. Other names are कुटाँव *kutānw* (Patna and North-West Bihār), डेरी *dheri* in Champāran, Tirhut, and South Munger, पैर *pair* in Champāran and Gaya, and धार *dhār* in South Bhagalpur. In South-East Tirhut it is also उकाम *ukām* (also in Patna) or उकुम *ukum*, and in Shahabad उकाँव *ukāñw*.

893. *The heaped grain.*—This is रास *rās* or डेरी *dheri*, also in North-East Tirhut खोर *khoh*. Over this is placed a cake of cowdung to avert the evil eye. This is बड़ाँव *barhānw* (Patna and West Bihār) and बड़बाँव *barhāwan* in Gaya and the west; but बड़ाँव *barhānw* is more properly the dung deposited by the bullocks while treading. Other names for the cake are महादे *mahāde* or महादेव *mahādeb*. A

piece of moist earth stamped is sometimes used in the same way, and is called चाकल *chākal* to the west and चप्पा *chhappa* generally. In South-East Tirhut a piece of wood so used is called जाक *jak*.

894. *The heaped straw and chaff.*—Straw in bundles is पूसा *pūsa* in Patna and north of the Ganges, except in North-East Tirhut, where it is ऋह्या *jhatua*. South of the Ganges, and optionally in Sāran, it is चाँटी *ānti* or चँटिया *antiya*, except in the south-east, where it is पुसा *pulla* or बिड़ा *biṛa*. Loose straw that has been threshed is पुचरा *puara* (to the west) or पुचार *puār* (to the east). Local variants are पौरा *pora* (also in West Tirhut) or पोचार *poār* in Patna and South Munger. When it has not been threshed, but has been left standing in the field after the ears are cut off, and then itself cut, it is called नार *nār*, and also (to the east) लार *lār*. Its stalks are whole, and are not crushed like threshed straw. नेवारी *newāri* is straw which is cut with the ear, but is not trodden by bullocks. It is tied up in bundles, and the heads are beaten against the ground. The husks of the grains are भूसा *bhūsa* or हस्रा *bhussa*. South of the Ganges a nasal is generally inserted—thus, भूँसा *bhūṅsa*. Other names are कट्या *katua* in Patna and Gaya, गुण्डो *gundo* in Champāran and South Bhagalpur, and खकरा *khakhra* or दुङ्गा *dhulla* in South Munger. Bran is चोकर *chokar*, also in Patna and the west भूँसी *bhūnsi*. Other names are चलोँसी *chalaunsi* (Patna and the west), कोरार *korāi* (Patna, Tirhut, and the west), चोँकर *chonkar* in Champāran and Patna, and चोकरा *chokra* in South Munger. The heaped straw on the threshing-floor, or a stack of straw anywhere, is गँज *gānj* or टाल *tāl*. सिल्ली *silli* is also specially used for the heap of straw on the floor.

895. An enclosure for stacking straw or fuel is घेरान *gherān* in West Tirhut, Sāran, and Champāran, घोरांन *ghorān* in Shahabad, and घेरा *ghera* or ढाठ *dhāth* in Champāran and Tirhut, the latter specially to the east. To the west it is पुरवट *purvat*. A house for holding chaff is सुसौल घर *bhusaul ghar* in the north-west and West Tirhut, and सुसकार *bhuskār*, सुससुलना *bhussbhulba*,* or (also in Champāran) सुसकार *bhushkār* to the east. In South-West Shahabad it is भुँसौर *bhunsaur*, and to the west generally of that district भुँसहल *bhūnsāhul*. In Champāran and Patna it is भौँसौल

* As in the proverb बूटल घोड़ सुससुलनाहिँ टाढ़ *chhūtal ghor bhussbhulbahin thārḥ*,—a horse, when he gets loose, stays in the chaff-house.

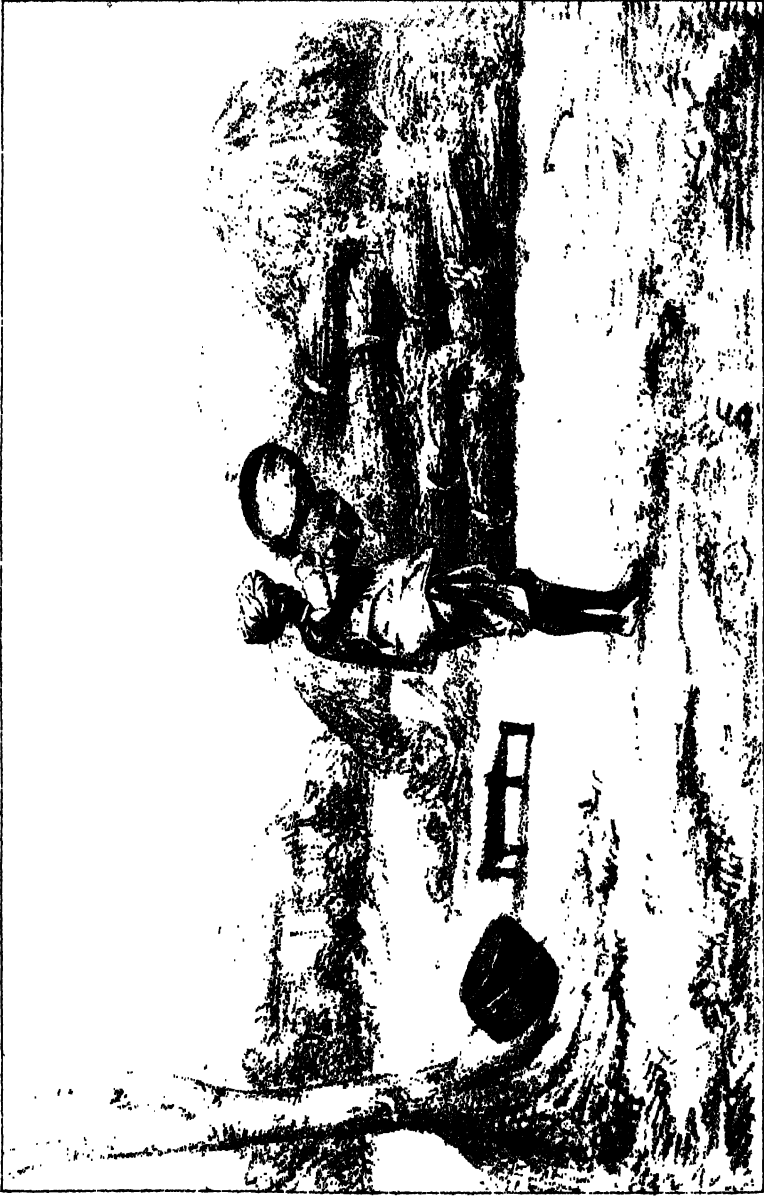

WINNOWING (OSAUNI)

bhoṅsaula, and there and in Gaya *बुसा घर bhusa ghar*. In Champāran and South Munger it is *बुसघर bhusghar*, and in South Bhagalpur *बुसकारी bhuskāri*. *खोंप khomp* or *खोंपी khompi* north of the Ganges is a small shed for chaff. The round thatch covering a *खोंप khomp* to save it from the weather is *खोंप के मथनी khomp ke mathni*, *चावनी chhāoni*, or *टोपड़ topar*. In South-East Tirhut *चांग chāng* is a large basket for holding chaff equalling four *टोकड़ी tokri*. *टंगौर tangaur* in the same place is a similar one, but is rougher and made of *rahar (Cytisus cajan)*.

896. *The refuse straw and fodder*.—This is in the north-west *गोघार gothār*, to the west and in North-West Tirhut it is *लथेर lather*, in Champāran and North-East Tirhut *निघास nighās*, and South-East Tirhut *निघेस nighes*. South of the Ganges and in Champāran it is *दाँटी dānti*. The refuse straw of the *rabi* or spring-crop, and specially of the *rahar (Cytisus cajan)*, is *ररेठा raretha* generally south of the Ganges, local variants being *लरेठा laretha* in South Bhagalpur, and in Champāran *रहेठा rahetha*. In Patna it is also called *खरई kharaī*. The refuse straw of the autumn crop is *दाँठ dānth* or *दुँदका dantuka* or *कुटका kutka* north of the Ganges. It is also to the west and in Patna *डडा dhattha*, and elsewhere *दाँट dānt*, *दाँटा dānta*, or *दाँटी dānti*. In South Bhagalpur and Patna, however, it is *ठठेरो thathero*. The dry stalks of mustard (*सरिसो sariso*) are *सन्धी santhi* in the north-west, *तिलन्डी tilthi* to the west and in North-West Tirhut, *नोरियाठी toriyāthi* in South-West Tirhut, *नोरियठ toriyath* in Shahabad, and *तिलाठी tilāthi* generally. The stalks of cereals without the ear are *जंगरा jhengra* to the west and in South-West Tirhut, *जंगटा jhegtu* in Champāran, *दाँट dānt* in the rest of Tirhut, *जङ्गा jhanga* in Champāran, and *जाँग jhāng* also in South-East Tirhut.

CHAPTER V.—WINNOWER.

897. *Winnowing grain* is *ओसौनी osāuni*. To winnow is *ओसाएव osāēb*.

898. The fine chaff which is blown away by the wind in winnowing is *पम्बी pambhi* generally; also *पान्की pānki* or *पाम्बी pāmbhi* to the west, *गुँड़ी gūnri* in Champāran and South-East Bihar, and *भौंटा bhaunta* in Patna. South of the Ganges these words are confined to the winter (*Aghani*) crop. The words for the autumn (*Bhadōi*)

crop are *पुरेसी puresi* or *पुअरसी puarsi* to the west, and *पखनी pakhni* in Patna and Gaya. In South Munger *अधभारी adhbhari* is rice not fully developed, in which the ear is only half full, the rest being all chaff.

CHAPTER VI.—MISCELLANEOUS.

899. The gathering or collecting grain at one place in the time of harvest is *बटोरन batoran* or *खोदन lorhan*.

900. When grain is being weighed, an extra handful is thrown in to make up for dust, &c. This is called *पक्षुषा pachhua* generally, but also *कसर kasar* to the west and *फाव phāo* in the south-east. It is also called *लाभ lābh* in Champāran and South Munger.

901. The grain left on the threshing-floor after removing the bulk of the crop is *अगन्वार agwār* generally north of the Ganges, and *भाठ bhāth* in South-East Tirhut. South of the Ganges and in Sāran it is *तरी tari*. The gleanings and refuse grain on the threshing-floor are *पटपर patpar* in the north-west and *खखरा khakhra* to the west and north. The grain which is blown away with the chaff at the time of winnowing is *अगन्वार agwār* or *अगन्वारी agwāri* to the west, *अगाड़ agār* in Champāran, Patna, and Gaya, and *अगन्बर agbar* in the south-east.

SUBDIVISION VIII.

DIVISION OF CROPS.

CHAPTER I.—DIVISION AND VALUATION.

902. The division of crops on the *metayer* system between landlord and tenant is called *बटार batāi* or *बटेया bataiya*. Local variants are *बाँट bant* in Champāran and Gaya, *बाँटी bānti* in Champāran and South Bhagalpur, and *बाँटनु bantnu* in South-West Shahabad. Land so held is called *भाँवखोli bhāoli* or *बटेया•bataiya*, as opposed to *नगदी nagdi*, of which the rent is paid in cash. In South Bhagalpur the division of the crops is called *कुरताली kurtāli*.

903. In *बटार batāi* a certain fixed proportion of the crop is given to the landlord as rent, as described in the following chapter. When,

instead of a *proportion*, a certain fixed *quantity* of the crop per bigha is paid to the landlord, it is called *मनखप mankhap*, *मनखीका manthika*, *हुन्दा hunda*, or *मनखुन्दा mankhunda*. This is especially adopted in the case of *जिरात jirat* or home-farm lands when let to a cultivator. In Patna it is called *मनी बन्दोबस्त mani bandobast*.

CHAPTER II.—THE SHARES INTO WHICH THE CROP IS DIVIDED.

904. *Half to landlord and half to tenant*.—This is called *अधिया adhiya* north of the Ganges and in the south-west, in Patna and Gaya *अधबतैया adhbataiyya* or *पह pah*, in Champāran and the south-east *अधःबटिया adhbatiyya*. In South-West Shahabad they say *दू दाना में से एक दाना जमिदार लेखला, बाउर एक दाना असामी के देखला dū dāna meñ señ ek dāna jamidār lehala, āur ek dāna asāmi ke dehala*,—of two grains, the landlord takes one and gives one to the cultivator. The turn of the sentence which makes the landlord *give* the cultivator his share is worth noting.

905. *Seven-sixteenths to landlord and nine-sixteenths to the tenant*.—This is *नौसत nausat* or *नौसता nausatta*. The practice has only been noted in the west, Patna, Gaya, and South Munger. In South-East Tirhut the custom is only observed in respect to mangoes and jack-fruit.

906. *Nine-sixteenths to the landlord and seven-sixteenths to the tenant*.—This is *नौसता nausatta*. The practice has only been noted to the west and in Patna, Gaya, and South Munger; also (*सेरी नौसता seri nausatta*) in West Tirhut.

907. *One-third to the landlord and two-thirds to the tenant*.—This is *तेकुरी tekuri* or *तिहैया tihaiya* in Shahabad, Patna, and Gaya, *तेकुरा tekura* in South-West Shahabad, *तेखुरी tekhuri* in South Bhagalpur, *तेकुली tekuli* in Champāran, *तिहरी tisri* in Sāran and Champāran, and *तेसरी tesri* in South Munger. Not noted elsewhere.

908. *Two-fifths to the landlord and three-fifths to the tenant*.—This is *पचहु पचहु pachdu* to the west and in West Tirhut, *पचा दूचा pacheha dūa* in Patna, Gaya, and the south-east, and *पँचहु panchdu* to the west. Not noted elsewhere.

909. *Three-fifths to the landlord and two-fifths to the tenant*.—This is *पचहु pachdu* to the north-west, and *पाँचा दूचा pāncha dūa* in South Munger and Tirhut. Not noted elsewhere.

910. *Landlord one-fourth, tenant three-fourths.*—This is चौथैया *chauthaiya* in Champāran and South-East Tirhut and चौडेया *chauthaiya* to the west and in Patua and Gaya. Not noted elsewhere.

911. The following remarks as to custom south of the Ganges may be of use. The division into equal shares is rare, and is confined to the cases of high-caste tenants, or where a tenant has obtained a decree of the Civil Court restricting the landlord's share to one-half. Nine-sixteenths to the landlord and seven-sixteenths to the tenant is the customary rate, the two-sixteenths in excess which are claimed by the landlord being supposed to represent the cost of collection, irrigation, and watching the crops. When the landlord takes less than a half-share of the crop, as in §§ 905, 907, 908, and 910, it is only in exceptional cases, as in time of drought, or when a jungle or waste land has to be brought under cultivation, or when land requires much labour on the part of the tenant. In these cases the settlement is always for a limited period, say one, two, or three years, and is often on a progressive scale, *i.e.*, in the first year the landlord takes one-fourth, in the second year one-third, in the third year two-fifths, and thereafter half of the gross produce. When the landlord takes three-fifths and the tenant two-fifths (§ 909), it is a case of special agreement with a landlord, who lets his private (खुद कामन्त *khūd kāsht*) lands. • In calculating all these shares (except in the case of division by bundles, see § 913) only the net grain produce after threshing is divided. The tenant in addition takes all the straw.

CHAPTER III.—DEDUCTIONS AND REMISSIONS.

912. A deduction of one *ser* in the maund from the amount received by the tenant is called सुपही *supahi* to the west, and also सेरही *serhi* in Shahabad. A similar deduction of $1\frac{1}{4}$ *ser*s per maund is called in South Bhagalpur नेग *neg*, or perquisite. In the case of division by appraisement (see next chapter) an allowance is made for deficient produce. This is called to the west and in Tirhut छूट *chhūt*. South of the Ganges and in Champāran it is called गरकी *garki*, also नाबूद *nābūd* in Patna, छुट्ती *chhutti* in Gaya, गरकी परती *garki parti* in South Munger, and मरकी गरकी *marki garki* in South Bhagalpur. A similar deduction of $1\frac{1}{4}$ *ser*s in the maund is called in Champāran, Patna, and Gaya डेहसेरी *derhseri*; and when of two *ser*s, डुसेरी *duseri*. To the west दहार महार *dahār mahār* is the loss to both landlord and

tenant when the produce is deficient through inundation. A remission to a high-caste tenant is called पगड़ी *pagri* or माफी *māphi*. North of the Ganges पक्षुषा *pachhua* is an allowance made by the tenant for dust in the landlord's share of the grain. In Sāran and Patna अँजुरी *anjuri*, and in Shahabad अँजुर *anjur*, is an allowance of one or two *sevs* per plough taken by the tenant. खलिहानी *khaliḥāni* in Patna is an allowance claimed by the tenant, and so also is माँवर *bhāmvar* in Shahabad and मँगनी *mangni* or मँगन *māngan* ($\frac{1}{2}$ a *ser* in the maund) in East Munger.

CHAPTER IV.—MODE OF DIVISION.

913. This may be considered under two heads,—division on the field and division on the threshing-floor.

Division on the field.—This may be done either by actual division of the bundles (बोजा *bojha*) or by appraising (कनब *kanab*) the value of the crop. When the bundles of the cut crop are divided, this is called बोजबटार *bojhbatai* or (in Champāran and South-East Tirhut) खरबटार *kharbatāi*. To the north-west it is जजाती बटार *jujāti batāi*. The rough appraisement of the crops for the purpose of division is called कन *kan* or कूत *kūt*, or कनकूत *kankūt* or कनकुत्ती *kankutti*. When the valuation is done by appraisement it is called कनकुत्ती बटार *kankutti batāi*. It is also called दानाबन्दी *dānābandi* generally, भौकडा *bhaukatta* in Shahabad and the south-east, दमाव *damāo* or दमकट्टी *damkatti* in Shahabad, Pātna, and Gaya. When the crops are ripe for harvesting the landlord deposes an assessor (अमीन *amīn*) and an arbitrator (सालिस *sālis*) to the field. They are met there by the tenant and the village officials. The village measurer (कडाधर *kadhāhar*) then measures the field with the local pole, and the arbitrator goes round it, and after a consultation with the assessor and the village officials estimates the quantity of grain in the field. If the tenant accepts the estimate, the quantity is entered in the *patwāri's* field-book (खसरा *khāsra*) and the matter is at an end. If the tenant objects, his fellow tenants are called in as mediators, and if they fail to convince either party a test (परतार *partār*) takes place. On behalf of the landlord a portion of the best part of the crop is reaped, and an equal portion of the worst part is reaped on behalf of the tenant. The two portions so reaped are threshed and the grain weighed. On the quantity thus ascertained, the whole produce of the field is calculated and entered in the field-book. The tenant is

then at liberty to reap the crop and take it home whenever it suits his convenience. In calculating the amount due to the landlord from the whole estimated quantity a deduction in favour of the tenant of generally two *seers* per maund, called **छुटनी** *chhutti*, &c., (see § 912), is made to allow for deficient produce and for the cost of reaping, gathering, and threshing, which in this system of division is borne by the tenant. The remainder, thus calculated, is then divided into the respective shares of the landlord and the tenant, and the latter is debited with the landlord's share in the accounts. If he pays this amount within the year, it is paid in kind; but if he does not do so, its value in money is written against him as an arrear in next year's accounts.

914. *Division on the threshing-floor.*—This is **बटार खरिहानी** *batāi kharihāni*, **अगोर बटार** *agor batāi* (because it is watched or guarded till division), or **बटार** *batāi* simply. The man who weighs the grain is called **हटवा** *hatwa* north of the Ganges. He is also **हटवे** *hatve* in Champāran, Patna, and Gaya, **बाया** *bāya* or **बया** *baya* to the west, **सोनार** *sonār* in Patna, and **केचाल** *keāl* or **बनियॉ** *baniyān* in Patna and the south-east. His fees are called **हटवारी** *hatwāi* or **हटवारी** *hatwāi* north of the Ganges, and also **पडुषा** *pachhua* in Champāran and Tirhut. In Champāran and East Tirhut they are also **मनपारी** *manpāi* or **मनपौषा** *manpaua*. To the west they are **बेयार** *beyāi* or **पवही** *pawahī* ($\frac{1}{4}$ *ser* per maund), in Gaya and South Munger **चालवा** *chālsa*, in Patna and Champāran **धुरिया** *dhuriya* ($\frac{1}{4}$ *ser* per maund), and in the south-east **केचाली** *keālī* or **तौलार** *taulāi* (one *ser* per maund). When grain is measured instead of being weighed, 16 cups (**पैला** *paila*) of grain make one **आड़ा** *ārha*. In this system the crops are reaped under the supervision of both parties, and are gathered on a common threshing-floor (see § 879), and strictly watched by both parties. Threshing does not take place until all the crops of the village have been thus gathered. Neither party is allowed the use of the crop till the grain is threshed out, weighed, and divided. During the reaping period the tenant at the end of each day gets the gleanings of the field (**लोहा** *loṛha*, &c., see § 878), and a fixed proportion of the gross produce (**दिनौरा** *dinaura*, &c., see § 874), which go as wages to the reaper. From the joint crop the village artisans and officials (carpenter, blacksmith, shoemaker, accountant, &c., see §§1193 and ff.), who have worked all the year round for both tenants and landlords, receive their perquisites. When the heap of grain is ready for division, the grain

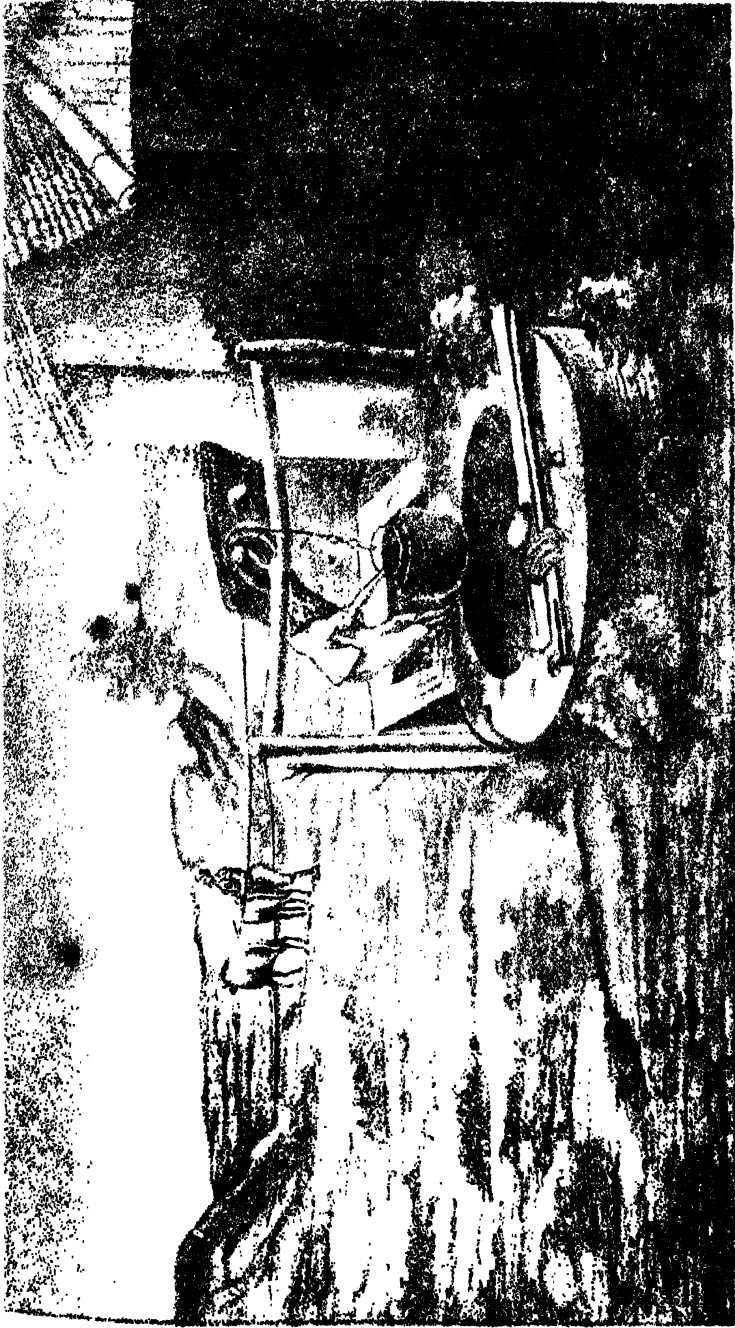

The skin bag for drawing water (moti), as worked with bullocks.

(Norz. -- The photograph had necessarily to be taken from a great height, which throws the picture somewhat out of perspective. Really the bullocks are going down hill, and the receiving vat is level.)

in Shahabad. In Gaya it is जसेर *jaser* or दसेर *daser*, and in Champāran, Patna, and the south-east खम्भा *khambha* or खम्हा *khamha*. Other names are थुन्ही *thunhi* in Patna and Shahabad and दोकानी *dokāni* in the south-east. The cross beam is बँडेरा *banrera* in the west, and बल्ला *balla* in South-West Tirhut. In parts of Shahabad it is अराठ *arāth*, and in Patna and Gaya पाठ *pāt*. The branches in which the pulley works are कन्ना *kanna* or कानी *kāni*, and the pulley axle खऔत *akhaut* or खऔता *akhauta*. Other names for this last are दण्डा *danda* in Champāran and South-West Tirhut, सररा *sarra* in South-West Shahabad, and टोना *tona* in Patna. The pulley itself is घड़ारी *gharāri* to the west, also गड़ारी *garāri* to the north-west and in South Munger. It is घिरनी *ghirni* in Champāran and South-West Tirhut, Patna, Gaya, and South Munger, गद्दा *gadla* in South-West Shahabad, घुरनी *ghurni* in Patna, and मकरी *makri* in Champāran and to the south-east.

CHAPTER IX.—THE PATHWAY FOR THE BULLOCKS, &c.

941. The sloping pathway for the bullocks is पौदर *paudar*, also दवर *dawar* in Shahabad, बहौ *bahū* in Gaya, and दगर *dagar* in Champāran, Patna, and the south-east. In South Munger it is also गोड़पौर *gorpaur*. The portion above ground is पौदर के मँथ *paudar ke mānth*, or to the west मथार *mathār*. The portion below ground is खोँछा *khoinchha* to the west. A yoke of well-bullocks is called मोटवा जोड़ी *motwa jori*. Drawing water by cattle power is मोट चलाएव *mot chalāēb*.

CHAPTER X.—THE WORKMEN EMPLOYED AT THE WELL.

942. The following labourers are employed at the well:—

The bullock-driver.—He is हँकवा *hankwa* or हँकनिहार *hanknihār*; also फेरवा *pherwa* in Shahabad.

943. *The man who empties the water-bag.*—He is धरनिहार *dharnehār* north of the Ganges, खिन्वा *khinwa* in South-West Shahabad, and मोटधरवा *motdharwa* in the rest of that district and in South Munger.

944. Both these men are called north of the Ganges मोटवाहा *motwāha*.

945. *The man who distributes water in the field* is called पनमोरा *panmora* or पनन्हाणा *panchhanna* north of the Ganges. South of the Ganges he is बरन्वाह *barwāh* in South-West Shahabad, मोरन्वाह *morwāh* in the rest of that district, and खँडुआर *khanruār* in Gaya. He is also खरन्वाहा *kharwāha* in Saran and खँडुआहा *khanrwāha* in Patna.

946. *The man who distributes the water with a spade* has already been described in Chapter I of this subdivision.

CHAPTER XI.—THE PERSIAN WHEEL.

947. The Persian wheel is not used in Bihār. Its name, राहत *rahat*, is however known in Patna.

CHAPTER XII.—IRRIGATION FROM TANKS AND STREAMS.

948. Water is raised from these either by the swing-basket or by the spoon-lever.

949. *The swing-basket.*—The swing-basket is generally सैर *sair* to the west and चाँड़ *chānr* in Central and Eastern Bihār. In Tirhut it is also डोस *dhos*, in South-West Shahabad दौरा *daura*, in Champāran and Gaya सर *sar*, and to the south-east सैन *sain*. The strings from which it swings are डोर *dor* or डोरी *dori*. The place where the men stand who work the basket is गोरन्पौर *gorpaur*, or to the west पौधा *pudha*. In South Bhagalpur it is सैनार *sainār*. The men who work it are सैरन्वाह *sairwāh*, चाँड़िवाह *chanriwāh*, or डोसन्वाह *dhoswāh* in the above-mentioned localities respectively. To work the basket is सैर (चाँड़ or डोस) चलाएब *sair (chānr or dhos) chalāēb*. In South Bhagalpur it is सैन बराएब *sain barāēb*. The pit from which the water is lifted is चड़ियार *chariyār* in Gaya and South Munger.

950. *The spoon irrigation lever.*—This is a long log of wood hollowed out like a spoon. It is so balanced that the bowl end is over the water to be raised. It is depressed into the water by the foot, and, rising by its own balance, discharges the water along its stem into the higher catch-basin. It is called दोन *don* to the west, and करीम *karim* or करौंग *haring* to the east. The man who works it is called दोनन्वाह *donwāh* and करिन्वाह *karinwāh* or करिँगन्वाह *karingwāh* respectively. The place where he stands is पौधा *pautha* in the west and अलमारा *altmara* in Tirhut.

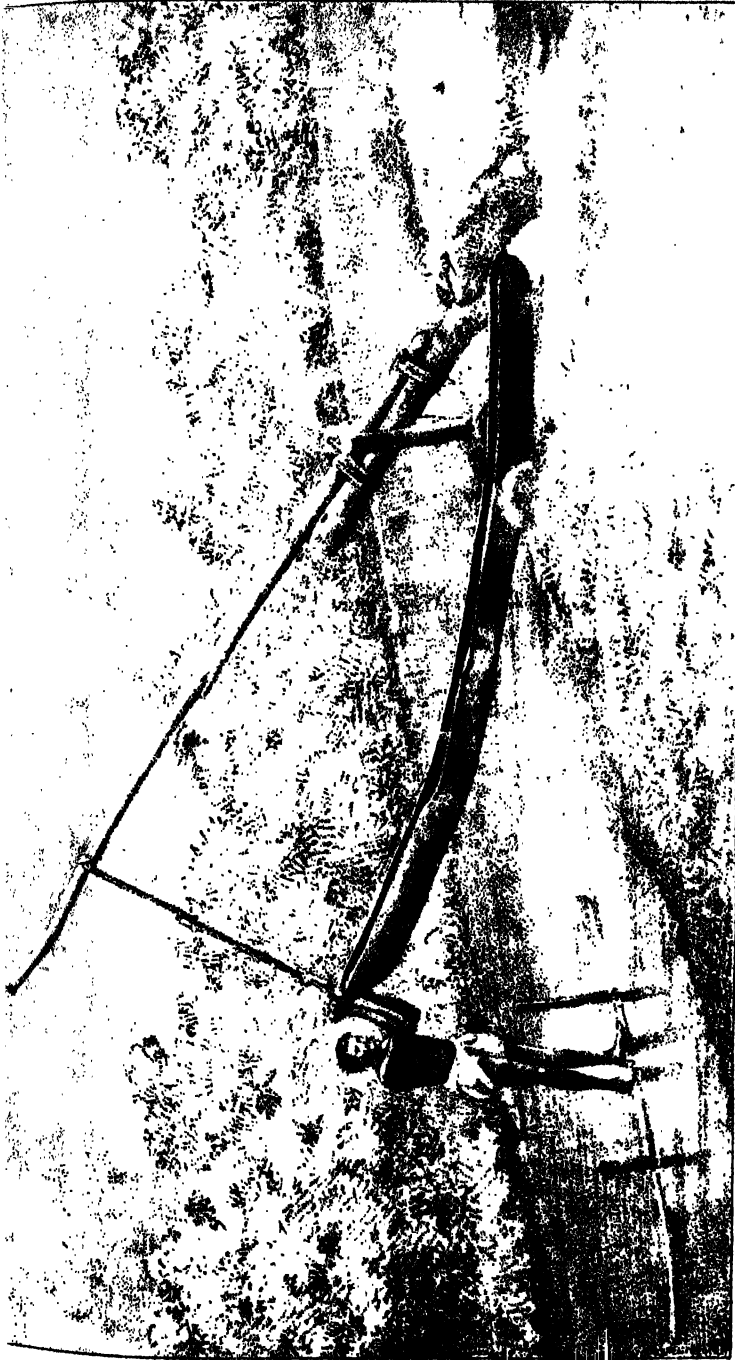

Irrigation lever (latka), showing the method of discharging water



Water-lifting with the swing-basket (sair or chant).

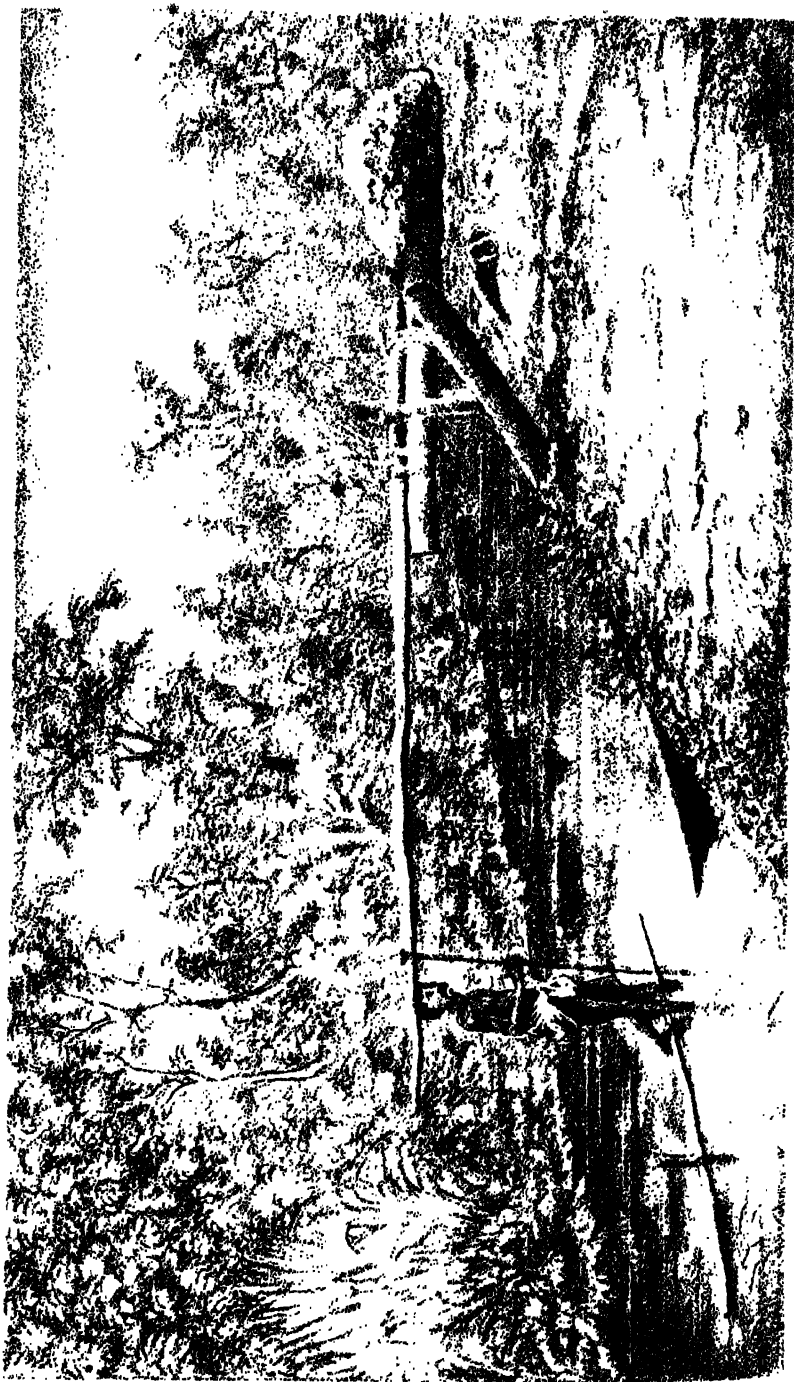

Irrigation tower (athra), showing the method of taking in water.

CHAPTER XIII.—WATER-LIFTS AND OTHER TERMS COMMON TO IRRIGATION BY THE SWING-BASKET AND THE SPOON-LEVER.

951. The height to which the water is lifted is **बोदर** *bodar* in Sāran and Shahabad, **अनुषा** *anua* in Champāran, and **गार** *gār* in North-West Tirhut. South of the Ganges it is **चढ़ाव** *charhāo*, **अनुषा** *anua* in South-West Shahabad, and **घर्षाव** *eghānw*, &c., as follows.

952. When there are several lifts, the first reservoir is called **ठेवका** *thewka* in the north-west, **पहला गार** *pahla gār* in North-West Tirhut, and **कानर** *kānar* in North-East Tirhut. South of the Ganges it is **खजाना** *khajāna* or **घर्षाव** *eghānw*. Of this last there are local variants **घरावा** *eghāwa* in Patna and **घराय** *eghāy* in South Bhagalpur. The top of the lift is **अड़ानी** *arāni* to the west, and **सीठा** *sītha* in South-West Tirhut, Patna, and Gaya. The catch-basin from which the water flows into the field is **तीथा** *tītha* to the west. It is also **परन्हा** *parchha* in South-West Shahabad, and **मेलवानौ** *melwāni* in Gaya.

953. When there are two or more lifts, the second from the bottom is **दोघाव** *doghānw*, with a local variant **दोघावा** *doghāwa* in Patna. The third is **तेघाव** *teghānw*, or in Patna **तेघावा** *teghāwa*. The fourth is **चौघाव** *choghānw*, or in Patna **चौघावा** *chaughāwa*. These lifts are also called **ठेवका** *theūka* in South-West Shahabad. Thus **दो ठेवका** *do theūka*, **तीन ठेवका** *tin theūka*, &c. The raised bank between the two reservoirs is **खानवाँ** *khānwān* in South-West Shahabad and **मैड़** *menr* in the rest of that district. In Gaya it is **पौड़** *pīnr*, and in Patna **अलङ्ग** *alang*. In South Munger and Patna it is **आधर** *āhar*, and elsewhere **बाँध** *bāndh* or **बान्ह** *bānh*.

CHAPTER XIV.—WATER-CHANNELS.

954. The channel which conveys the water into the field is generally **पैन** *pain* or **पैनि** *paini*. In Patna, Sāran, and Shahabad it is also **करन्हा** *karha*, and in South-West Shahabad **बाहा** *bāha*. In Tirhut it is **पौठ** *pauth* or **दवान** *dawan*, and in North-East Tirhut **पौठी** *pauti*. In South-East Tirhut it is **बाह** *bah*. To the west **नारी** *nāri* is also used. In the south-east and Champāran we find **दाँड़** *dānr*, and also (in South Bhagalpur) **सिंगहा** *singha*. In North-East Tirhut **कनवा** *kanwa*, and in Patna and Gaya **कनवाह** *kanwah*, is a narrow branch channel leading from a **पैन** *pain*. A water-course generally is **नदी**

naddi or (in South Bhagalpur) लद्दी *laddi*, and its branches बाबा *baha* or (north of the Ganges) बबना *bahna*. In Shahabad छेर *chher* is a shallow spring of water, and its branches निग्रैन *nigrain*. In Patna and Gaya भोकिला *bhokila* and टँडूवा *tanrua* are small water-channels. The latter is smaller than, and is a branch of, the former. A turn in a water-course is मोरानी *morāni* in Patna and the north-west, and घुमान *ghumān* in Chāmpāran and North-East Tirhut.

DIVISION V.

AGRICULTURAL PRODUCTS AND THEIR ENEMIES.

SUBDIVISION I.

AGRICULTURAL PRODUCTS.

CHAPTER I.—WHEAT.

955. Wheat (*triticum vulgare* or *sativum*) is गेहूँ *gehuñ* north of the Ganges. In East Bihār generally, however, it is गज्जम *gahum*. To the west it is also गेहूँ *gohuñ*, and elsewhere south of the Ganges and in North-East Tirhut गोज्जम *gohum*. In Gaya it is also मण्डा *manda*. Cf. § 823.

956. The chief varieties are मुँडिया *munriya*, a first-class beardless wheat. In South-West Shahabad this is मुँडिलवा *munrilwa*, मुडुला *murla* in Sāran and Patna, and मुडुली *murli* or भुँडिया *bhuñriya* in Gaya. दाउदी *dāudi* or दौदी *daudi* in West Bihar, or to the south-west and in Gaya दौदिया *daudiya*, is an excellent white beardless wheat. In Tirhut it is known as जमाल खानी *jamāl khāni*. A white round-bearded wheat is known as दूधी *dūdhi* or दुधिया *dudhiya* in South Tirhut, Patna, and South Munger. In South Bhagalpur it is पचरुकी *pachrūki*. लकवा *lalka* in Shahabad and South-West Tirhut, देसी *desi* or देसिला *desila*, and हरना *harna* or हाररावा *hārrahwa*, in the north-west, हारा *hāra* in Tirhut, हरहरा *harhara* in South-West Tirhut, हरहा *harha* (Patna), केवलवा *kewalwa* (Gaya), and जमाली *jamālī* or जमारिया *jamariya* to the east, are a small-grained red wheat. लकवा *lalka* also occurs in South Munger. North of the Ganges दोगला *dogla* is a mixed wheat composed of जमाल खानी *jamāl khāni* and हारा *hāra*. बरगहना *bargahana* in South-East Tirhut is a large bearded wheat. In Shahabad रेंडा *renra* means stunted wheat.

957. The germ of a grain of wheat is south of the Ganges पुत्ती *putti*. When a grain of wheat germinates first, the sprout is called सरया *sūiya* or सूया *sūa*; also अंकुरा *ankurha* to the north-west, and

कड़ी *kanni* in Patna. In North-West Tirhut it is डेफ *deph*, and to the east डेफी *dephi*. The phrase used is सुरवा गैल *suiya gail* north of the Ganges, or डेफ निकसल *deph niksāl* in North-East Tirhut. To the west they say रँडल बा *renral ba* or रँडु गैल *reñr gail*. In Gaya they say सुवाल चावे है *sua āve hai*, and in Patna कनियारल चाव है *kaniyāēl āva hai*. When it has further sprouted, but has not yet taken firm root, it is पुनरा *putra*. When the blade throws outshoots they are called डिब्बी *dibbi*; also डाम्बी *dābhi* in South-West Shahabad, and टँभी *tembhi* in Patna. When about six inches high it is called कौवा लुकान *kaua lukān* in Gaya, Sāran, and Shahabad, and कौवा भपान *kaua jhapān* in the south-east, both meaning sufficiently high to hide a crow. When it is cut unripe it is known as होरन्हा *horha*, or (Tirhut and the South-East) ओरन्हा *orha*, and (optionally) in South Munger as होलन्हा *holha*. When the ear begins to form, they say रँडा भैल बा *renra bhail ba* in the north-west, गभा भैल बा *gabha bhail ba* in South-West Tirhut, and गम्ह्रा भेल अछि *gamhra bhel achhi* in the rest of Tirhut. In Shahabad they say दुधियारल *dudhiyāēl*. In Patna and Gaya a similar phrase, or the phrase गदराएल है *gadräēl hai*, is used, and in the south-east they say दुधैलै *dudhailai*. गदराएल *gadräēl* is also used in Tirhut. When the grain hardens they say it is बबसाएल *habsāēl* in South-West Shahabad, कैलाएल *kailāēl* generally; in Sāran and West Tirhut also गोटाएल *gotāēl*, अधपक्कू *adhpakku* in Gaya, कैला गेल *kailu gel* in Patna, and कलाएल *kalāēl* in the south-east.

958. The beard is टूंड *tūnr* or टूंडा *tūnra* to the west, and सूँघ *sūngh* or सूँग *sūng* elsewhere. In South-West Tirhut it is सूँर *sūnr*. The ear itself is बाल *bāl*, except in North-West Tirhut, where it is बाली *bāli*; in South-East Tirhut, where it is सीस *sis*; in South Bhagalpur, where it is सीसा *sisā*; and in South Munger, where it is टुंगना *tunjna*.

CHAPTER II.—MIXED CROPS.

959. Wheat and barley grown together are गोजर *gojai*. A mixture of peas, gram, barley, or wheat, or any two or three of them, is called तेररा *terra* in South-West Shahabad, गजर मसर *gajar masar* in the rest of that district, गजर बजर *gajar bajar* in Champāran, गजा बजा *gaja baja* south of the Ganges generally, and उटरा *utra* in Patna. In the north-west it is पैरा *paira*, in West Tirhut पैर *pair*, and in East Tirhut पौर *paur* or बेहरा *behra*. Barley grown with the smaller pea (केराव *kerāo*) is जौ केराव *jau kerāi*

generally, also **जौ मट्ठरा** *jau matra* to the west, **जकेरार** *jakerāi* to the south-east, and **जब केरवा** *jab kerwa* in North-East Tirhut. Other names are **कुसही केराव** *kusahi kerāo* in Patna and the south-east, **कोसी** *kosi* in South Bhagalpur, and **हरफोरवा केराव** *harphorwa kerāo* in South-West Shahabad. **बेररा** *berra* or **बेरई** *berāi* in Shahabad is barley mixed with gram, and the same is called **जब बुट्टा** *jab butta* north of the Ganges, and **जो बुट्टा** *jo butta* in the south-east. **जो खेसरा** *jo khesra* is a mixture of barley and peas (**खेसारी** *khesāri*) in the south-east.

960. When there is a mixture of crops, the inferior one is called **तरी** *tari* when compared with the other. Thus in **जौ केरार** *jau kerāi* the small pea (**केराव** *kerāo*), being the inferior, is the **तरी** *tari*.

CHAPTER III.—BARLEY AND OATS.

961. Barley (*hordeum vulgare*) is **जौ** *jau* generally. In the north-east it is **जब** *jab*, and in Patna and the south-east **जो** *jo*. North of the Ganges **जई** *jaī* (also in Shahabad) or **जन्तरी** *jantari* are shoots of barley artificially grown and distributed by Brahmans at the festival of the Dasahra. In Gaya they are **जवारा** *javāra*, and in Patna **जैती** *jaiti*. The prickly hairs on the ear are **टूँडा** *tūnr* in West Tirhut, Sāran, and Shahabad; **टूँडा** *tūnrā* or **सूँडा** *sūnrha* in Champāran and Tirhut; **सूँद** *sūnr* in South-West Tirhut, and also **सूँघ** *sūngh* or **सूँग** *sūng* in Patna and the east generally.

962. Oats (*avena sativa*) are called the sister of barley, and are hence named **जई** *jaī* or **जैजू** *jaijū*.

CHAPTER IV.—RICE.

963. Rice (*oryza sativum*), whether as a crop or threshed but unhusked, is called **धान** *dhān*. When husked it is **चाउर** *chāūr*, but the Hindi form **चावल** *chāval* has also been noted in Patna. Husked rice is of two kinds, viz. **अरवा** *arwa*, which is not parboiled before husking and is eaten by the higher castes, and the cheaper, which is parboiled before husking and is eaten by the lower castes. This latter is called **उसना** *usina*, **उसना** *usna*, or **जोसाँदा** *josānda*. Rice when partially husked is called **मुहचुर** *muhchur* in Gaya, **बोकड़ा** *bokra* in Sāran, and **खियावा** *khijāva* in North-East Tirhut. Rice boiled plain is **भात** *bhat*, when boiled with pulses it is **खिचड़ी** *khichri*, and when spices are added to this it is **भुनस खिचड़ी** *bhunals khichri* or **कबुली** *kabūli*; also in

South Bhagalpur चौकी *chhauki*. When rice is boiled to a mash, it is called गोलहथ *golhath* or गोलहथी *golhatthi*. In Gaya पनीहता *panihata* is a dish made by adding water to the rice left from last night's supper. In addition to the usual names, लार *lār*, पोचार *poār*, &c. (see § 894), the long straw of transplanted rice is called मोरी पेटारी *mori petāri*, or (in Champāran) पेटारी *petāhi* or (in Shahabad) पेटारी *petārhi*.

964. The varieties of rice grown in Bihār are very numerous, as is borne out by many proverbs, such as the following :—रजपूत ओ धान के ओर नाहिँ है *rajput o dhān ke or nāhiñ hai*,—there is no limit to the clans of Rajputs or the kinds of rice; धान बाभन के एके हल *dhān bābhan ke ekke hāl*,—rice and Bābhans are one and the same (in number of kinds). Rice may be divided into two broad classes, those which are sown at once broadcast and are called बावग *bāwag*, बाबोग *bāōg*, (in Gaya) बोगेडा *bogera*, or in Patna बोगेडा *bogha*, and those which are sown in seed-beds and transplanted, being called रोप *rop* or रोपा *ropa* or (in Gaya and Patna) रोपेडा *ropha*. At the same time it should be noted that practice varies with locality, and that a kind of rice which is बावग *bāwag* in one place may be रोपा *ropa* in another.

A.—RICE THAT IS SOWN BROADCAST.

965. (1) साठी *sāthi*.—This is a red rice, and ripens in sixty days from sowing, as in the proverb—

साठी पाके साठ दिन,
बरखा होखे रात दिन.

Sāthi pāke sāth din,
Barkha hokhe rāt din.

—*Sāthi* ripens in sixty days if it rains night and day.

In the east it is also called गम्हरी *gambhri* or गम्हरी *gambri*. It is sown in the month of Jeth (May-June), and is cut in Sawan (July-August).

(2) सोकना *sokna* (north-west).—This is sown with the first fall of rain in Jeth (May-June), and is cut in Bhādoñ or Āsin (*i.e.*, in September). This crop is also called भदैया *bhadaiya*.

(3) The following are sown in Phāgun (February-March) and Chait (March-April), and are cut in Aghān (November-December). The names were principally

collected in *East Tirhut*, and unless the contrary is specially stated do not apply elsewhere:—

- (a) अकाल गीर *akāl gir*. (In Sāran अकाल गीर *akāl gir*, and in North-East Tirhut also काला गीर *kāla gir*.)
- (b) उजागर *ujāgar*, or in Sāran जागर *jāgar*, which name is also current in North-East Tirhut.
- (c) चनाबक *chanābak*.
- (d) झलमरन्दन *jhalmandan*.
- (e) दरमी *darmi* (also known in the north-west).
- (f) देसरिया *desariya* (Tirhut and Champāran). In Sāran it is called जरिया *jasuriya*.
- (g) पीचर *pīchar*.
- (h) बेकौर *belaur* (also known in the north-west).
- (i) भौंठिन *bhāntin* (Sāran).
- (j) भौसलेट *bhaistlet* (also known in the north-west).
- (k) लॉजी *lānji* (Sāran).
- (l) सतरिया *satariya* (Sāran).
- (m) साहिल *sāhil* (Sāran).
- (n) सिंगरा *singra*.
- (o) सोबरा *sobra*.

खेड़ा *kherla* is a white bearded rice sown all over Tirhut and in Champāran. The following (also East Tirhut) are sown in Jeth (May-June). They are sometimes sown broadcast and sometimes transplanted:—

- (a) धुसरी *dhusri* (also known in Champāran).
- (b) बस्तार *bastar*.
- (c) राम दुबारी *rām dulāri*.

966. In *South-West Shahabad* the following kinds of rice are sown broadcast:—

- (a) करंगा *karnga* } Two kinds with a black grain (also known
- (b) करंगी *karngi* } in Sāran).
- (c) करहन्नी *karhanni*, a small black grain (also known in Sāran).
- (d) खाटिन *khātin*, a coarse kind.
- (e) सहदेरिया *sahdeīya*, a red kind.
- (f) साठी *sāthi*. See above.

(g) **सेडा serha**, a small black and white grain. Like the **साठी sāthi**, it ripens in sixty days. The South-West Shahabad version of the saying already quoted is—

सेडा साठी साठ दिन, जेव देव बरसे रात दिन
Serha sāthi sāth din, jemu deb barse rāt din.

—*Serha* and *sāthi* take sixty days if it rain night and day.

In the rest of *Shahabad* the following kinds of rice are sown broadcast:—

- (a) पनसारी *pansāri*.
- (b) भुईसीकर *bhuinsīkar*.
- (c) मूंगा *mūnga*.
- (d) राम करन्हनी *rām karhanni*.
- (e) राम दुलारी *rām dulāri*.
- (f) साहिल *sāhil*.
- (g) सिरन्हण्ड *sirhant*.

967. In *Gaya* sowing is done in the month of *Akhār*, in the lunar asterism of *Aradra* (June–July). About this asterism (नक्षत्र *nachhattar*) and the two following ones the following rhyme is current throughout *Bihār*:—

अरद्रा धान, पुनरबस पैसा
 गेल, किसान, जे बोए चिरैया
Aradra dhān, Punarbas paiya,
Gel, kisān, je boe Chiraiya.

—Paddy sown in *Aradra* turns into plenty, sown in *Punarbas* to chaff, and sown in *Chiraiya* (or *Pukh*) it turns to nothing.

The paddy is generally cut in the month of *Pūs* (December–January).

Amongst the kinds of paddy sown broadcast in this district are—

- (a) एदली *ēlli*.
- (b) कतिका *katika*,—cut in *Katik* (October–November).
- (c) कम्बदा *kanbada*.
- (d) करन्हनी *karhanni*.
- (e) जोंगा *jonga*.
- (f) ज्हाँगा *jhanrga*.
- (g) धुसरा *dhusra*
- (h) रटवा *ratica*.
- (i) लालदेरवा *laldeiya*.

- (j) लोहरा *lohra*.
 (k) सिरहती *sirhatti*.

968. In *Patna* on the first fall of rain, which generally takes place in the asterism of *Rohini*, in the month of Jeth (May-June), the sowing is commenced. Paddy which is sown broadcast is divided into two classes—a red, which is considered superior, and is called ललग्गोंदिया *lalgondiya*, and a black, which is considered inferior, and is called कारा बोग्गहा *kāra bogha*. The former kind includes करहन्नी *karhanni* as the principal. The ear is black.

969. In *South Munger* the following kinds are sown broadcast :—

- (a) अजान *ajān*, a white variety.
 (b) कजरौ *kajri*.
 (c) करहन्नी *karhanni*. See above.
 (d) खिरदन्त *khirdant*.
 (e) छग्रा *chhagra*.
 (f) जौगा *jauga*.
 (g) पनसाहा *pansāha* (a coarse red kind).
 (h) बुहवा *burhua*.
 (i) राँगी *rāngi*.
 (j) सरिहन *sarihan*, a white variety.
 (k) सिरहती *sirhatti*.

970. In *South Bhagalpur* the following kinds are sown broadcast :—

- (a) कजरघरो *kajargharo*.
 (b) गोहमा *gohma*.
 (c) चाँग *chāng*.
 (d) जौगा *jonga*.
 (e) डुदसर *dudsar*.

B.—RICE THAT IS TRANSPLANTED.

971. This rice is generally sown with the first rains in Jeth (May-June). It is transplanted in Sawan (July-August). In *Patna* the custom is to commence transplanting on the 5th of Sawan, after holding a festival, called नकपंचो *nakpāncha*, or the “fifth of the asterism (नखत *nakhat*).” The regular harvest is held in Aghan (November-December). Before this, however, some is cut for the ceremony of बिसुन पिरिन *bisun pirit* (called in *Sāran* बिसुनटिया *bisunatiya*), at which *Brāhmins* are feasted on the new grain.

972. The following kinds of rice are transplanted in *Tirhut* :—

- (a) अङ्गा *anga*, a black bearded kind.
- (b) कनक जीर *kanak jir* (East Tirhut).
- (c) कमोच *kamoch*, a black kind grown in North-West.
- (d) करन्मा *karma*, a long black kind (Tirhut).
- (e) गड्ढा *gahuma*, a red flat kind grown in North-East Tirhut.
- (f) जगरन्थिया *jagarnathiya*, a similar kind grown in North-West Tirhut.
- (g) दुधराज *dudhrāj*, small and white.
- (h) नन्धिया *nanhiya* (East Tirhut).
- (i) बहरन्नी *baharni* (North-West Tirhut) or बहोरन्नी *bahorni* (North-East Tirhut), a long white variety.
- (j) भाल सरी *bhāl sari*.
- (k) मनसरी *manasri*, a red variety (also known in Sāran).
- (l) माल भोग *māl bhog*.
- (m) रमुनी *ramuni* (also known in Sāran).
- (n) लाल देर्या *lāl deīya*, or in Sāran लालदेर्या *laldeīya*, a red variety.
- (o) सरिहन *sarihan* (north of the Ganges generally), sown in Baisakh (April-May) and cut in Sāwan (July-August).
- (p) सिलहट *silhat*, with a black husk but white grain.

973. In *South-West Shahabad* the following are transplanted :—

- (a) जलहोर *jalthor*, possesses a fine grain.
- (b) भेंगी *jhengi*, a white variety.
- (c) दुधकाँड़र *dudhkānrar*, white.
- (d) बासन्मती *bāsmati*, a superior white variety.
- (e) बैतरन्नी *baitarni*, a reddish kind.
- (f) भेंङ्काबर *bhenrkābar*, a coarse red kind.
- (g) माल देही *māl dehi*, a fine-grained variety.
- (h) मुटुनी *mutuni*, white.
- (i) रामजूषा *ramjūa*, fine.
- (j) लॉंगचूरा *longchūra* (a black and very fine variety).
- (k) सिरी केबल *sirī kebal*, white.

974. In the rest of *Shahabad* the following are transplanted :—

- (a) कनकजीरा *kanakjira*.
- (b) दुलहरा *dulahra*.
- (c) दोलङ्गी *dolangi*.

975. In *Gaya* the following are transplanted :—

- (a) कमन्हा परन्साद *kamla parsād.*
- (b) गजन्पत्ता *gajpatta.*
- (c) गुडन्रा *gulra.*
- (d) गोखुल फूल *gokhul phūl.*
- (e) गोपाल भोग *gopāl bhog.*
- (f) ठाकुर भोग *thākur bhog.*
- (g) दुधगिलास *dudhgilās.*
- (h) धनीवा *dhaniwa.*
- (i) नौ धारा *nav dhāra.*
- (j) बकोइया *bakoiya.*
- (k) बत्तास फेनी *batās phenī.*
- (l) बत्तासा *batāsa.*
- (m) बन्नीटी *brāntī.*
- (n) बांसन्मती *bāsmatī.*
- (o) माधन्वा *mādhwa.*
- (p) मुरन्धी *murdhī.*
- (q) लाल केसर *lāl kesar.*
- (r) साम जीरा *sām jīra.*
- (s) सुगा पङ्खी *sūga pankhī.*
- (t) सेल्हा *selha.*

976. In *Patna* the following are transplanted :—

- (a) बसन्मतिया *basmatiya.*
- (b) सफेद *saphed.*
- (c) सियाह *siyāh.*
- (d) सेल्हा *selha.*

977. In *South Munger* the following are transplanted :—

- (a) अनार कली *anār kali.*
- (b) कजरी *kajri.*
- (c) कचन चूर *kanchan chūr.*
- (d) कारी बाँक *kāri bānk.*
- (e) गजन्पती *gajpati.*
- (f) तुलसी फूल *tulsi phūl.*
- (g) दोलन्गी *dolgi.*
- (h) बांसन्मती *bāsmatī.*
- (i) लुपन्धी *lupdhī.*
- (j) सित्ती सार *sītī sār.*
- (k) सेल्हा *selha.*

978. In *South Bhagalpur* the following are transplanted:—

- (a) कनक चूर *kanak chūr*.
- (b) कमोदी *kamodī* (a sweet-scented variety).
- (c) गोखुल सार *gokhul sār*.
- (d) दौना फूल *dauna phūl* (a sweet-scented variety).
- (e) बाग नर *bāg nar*.
- (f) बाँस फूल *bāns phūl*.
- (g) बाँसन्मती *bāsmatī*.
- (h) बासा पसिन *bāsa pasin*.
- (i) मनसरा *mansara*.
- (j) रमनिषा *ramaniya*.
- (k) राम दुल्लर *rām dullar*.
- (l) हसन्चा *hamcha*.

979. Of all the above rices, the most esteemed is सान जीरा *sām jīra*. It is a fine kind, and when cooked its fragrance fills the house. The next best is बाँसन्मती *bāsmatī* or बसन्मतिषा *basmatiya*, which is not quite so fine as the first. सेल्हा *selha* may be considered as the third best.

C.—OTHER MISCELLANEOUS KINDS OF RICE.

980. बोरो *boro* is a poor kind of rice sown in Āsin (September–October) or Katik (October–November) in the mud on the banks of streams and lakes. It is transplanted several times in Pūs and Māgh (December, January, and February). लमेरा *lamera* or (in South-East Tirhut) झर *zhar* or in (Sāran) झारन *jhāran* is rice which has fallen from the sheaves when reaping, taken root, and grown next year.

981. *Rice-lands*.—Land which has been under a rice-crop is धनखर *dhanhar*, धनखेत *dhan-khet*, or धनखेती *dhan-kheti*. It is also धनखर *dhan-khar* in Shahabad, धनकियारा *dhan-kiyāra* in Gaya, and धनखा *dhanha* in Patna. Fresh waste land ploughed up for rice sowing is खिलनार *khilmār*; also नवाद खेत *nawād khet* north of the Ganges, and नौखील *naukhiḷ* in Gaya. In the south-east it is खिलकट *khilkat* or खिलकट्टी *khilkatti*. To dig it in order to make it fit for sowing is खील कोड़व *khīl korab* or खील तोड़व *khīl torab*. The preparation of a rice-field is कादो (or कदवा) करव *kādo* (or *kadva*) *karab*; also लेव करव *leo karab* in .

Saran, and मसाह करव *masāh karab* in Champāran. A man who cultivates rice is धनन्हा *dhanha* to the west.

982. *Seedlings*.—A nursery for rice seedlings is बिड़ार *birār* or बियार *biyār*. In South-West Shahabad it is बंगा *benga*. The seed is बीहन *bihan*, बिहन्ना *bihnāi*, or बीया *biya*, and the same words are also used for the seedlings of any crop; but the seedlings of rice are specially called मोरी *mori* south of the Ganges and to the west. They are also called जरई *jarāi* in Champāran. The bundles of rice seedlings ready for transplanting are चाँटी *ānti* or अँटिया *antiya* north of the Ganges and in the south-east, and the quantity transplanted at one place is everywhere except to the south-east बान *bān*. Seedlings of बोरो *boro* rice which have been transplanted once and are again transplanted are called in North-East Tirhut खार *khāru* or खरहान *kharuhān*. For fuller information concerning seedlings and transplanting, see 855 and ff.

CHAPTER V.—INDIAN CORN OR MAIZE.

983. Indian corn or maize (*zea mays*) is मकरै *makarai* or मकैया *makaiya*. It is also called जनेरा *janera* in the west and जिनेरा *jinera* in Patna, which names ought properly to be applied to the large millet (*holcus sorghum*). The stalks are दहा *dhattha* to the west and ठठरा *thathera* to the north generally. In South Bhagalpur they are ठठेरो *thathero*, and elsewhere डाँट *dānt* or डाँटी *dānti*. The broken stalk is लथेर *lathēr* in the North-West and West Tirhut, and निघास *nighās* or निघेसा *nighesa* in East Tirhut. No special name for this has been noted south of the Ganges.

984. When the grains begin to form, but are not yet fit for eating, the ear is called सचा *sancha*. The unripe ear is दुहा *dudha* to the west generally, and also दोषा *dodha* in Shahabad. Other names are खिच्चा *khichcha* or अजू *aju* in Tirhut, दुधघोहू *dudhghottu* in Gaya, दुहा मकरै *dudha makai* in Saran and Patna, दुधभोरो *dudhbhoro* in South Bhagalpur, and दँतकमरा *dantkamra* in South Munger. When ripe it is भुहा *bhutta* or बाल *bāl*. When the seeds are ripe and hard, and not fit for eating, it is called पकठारल *pakthāil*. The roasted ear is चोरन्हा *horha* generally, and also ओरन्हा *orha* to the east. The empty cob after the grain is beaten out is लँहा *lenrha* generally; also नेहा *nerha* in East Tirhut and लँहुरी *lenruri* in Shahabad. In Patna and South-East Tirhut an optional name is बलुरी *baluri*, and South-East

Tirhut and South Munger बहनरी *batri*. In South-West Shahabad the word used is खुखुरी *khukhuri* or खोंखरी *khonkhri*, and in South Bhagalpur हड्डी *haddi*. The grain beaten out is गोटा *gota* or गोट *got*. An ear with no grain in it is called भोराह *bhorāh* or भोरहा *bhorha* north of the Ganges. When it contains only a few grains it is called पचगोटिया *pachgotiya*. The hair on the ear is भूषा *bhūa* to the west; also घूषा *ghūa* in South-West Shahabad. In Champāran and Gaya it is called सन *san*. In Patna it is मोंह *monchh*; in South Munger, मोहा *mochha*; in Tirhut and South Bhagalpur, मोच *moch* or मोचा *mocha*. It is also called केशी *kesi*. The sheath of the cob is खोइया *khōiya* to the west, and बलखोइया *balkhōiya* or बोकन्हा *boklu* generally. In Champāran another name is खलखोइया *khalchōiya*, and in South-West Tirhut बलको *balko* or कोसा *kosa*. In East Tirhut it is खोंइचा *khoincha*, in South Munger पतौरा *pataura*, and in South Bhagalpur पोचो *pocho*. The male ear is called धनबाल *dhanbāl* or धनहरा *dhanakra*.

CHAPTER VI.—THE LARGE MILLET.

985. Large millet (*holcus sorghum* or *sorghum vulgare*) जनेर *janer* or जनैरा *janera* generally. A variety of it is called मसुरिया जनेर *masuriya janer* to the west to distinguish it from maize (*zea mays*, see last chapter). So also it is called नन्हिया जनैरा *nanhiya janera* in East Munger. Local names are गडमा *gehuma* and जोहरी *johri* in Sārau, जिनोरा *jinora* in Patna and Gaya, and गडमा *gahuma* in South Bhagalpur. Amongst its varieties may be mentioned a large red kind grown in Shahabad, called जोंधरी *jondhri*. This is called सिधुचा गडमा *sisua gahuma* in South Bhagalpur. A similar red kind is called रकसा *raksu* or रकसी *raksi*. This millet is little grown south of the Ganges. The only other kind noted there is बखन्डा *bajra*, which is described as a dwarf white variety (see however § 987). North of the Ganges दुधिया *dudhiya*, or (in South Tirhut) लरकटिया *larkatiya* or नरकटिया *narkatiya*, is a dwarf white variety. The following also occur north of the Ganges:—भलरिया *ghalariya*, of which the head bends down, and which ripens late. जेठी *jethi* in the north-west is a kind sown for fodder. A kind with two grains in one husk is called गेंडुआँ *genhuān*.

986. The stalks cut up for fodder are डठेरा *dhathera* or डठा *dhattha* to the west, and डठेर *thather* or डठेरा *thathera* to the east. When the

young plant first germinates it is **अँकुरा** *ankura*, and the young plant is **डिभी** *dibbi* or **डौभी** *dābhi*. The ears are **बाल** *bāl*, or in East Tirhut optionally **सीस** *sīs*. The large stack of the stalks cut up for fodder is **गँज** *gānj* to the west and **टाल** *tāl* to the east. Local names are **खन्हार** *khanhār* or **काँड़** *kānr* in South-East Tirhut.

CHAPTER VII.—THE SMALL BULRUSH MILLET.

987. This millet (*holcus spicatus* or *penicillaria spicata*) is **बजन्डा** *bājra* in Sāran. South of the Ganges it is sometimes incorrectly called **मसुरिया जनेर** (or in Patna **जिनोरा**) *masuriya janer* (or in Patna *jinora*), which is properly a different grain, a variety of the large millet (*holcus sorghum*; see § 986). In South West Shahabad it is **जोंधरिया** *jondhariya*, and in South Bhagalpur **गहमा** *gahuma*. Just as the large millet is grown principally north of the Ganges, so this millet is grown almost entirely south of it. Hence there is great confusion in their names. The following terms relate exclusively to South Bihar:—The stalk is **दाँट** *dānt* or **दाँटी** *dānti* everywhere; also **दडा** *dādtha* in Shahabad and **ठठेरो** *thathero* in South Bhagalpur. The first shoots of the plant are **अँखुआ** *ankhūa* or **खुआ** *sūa*; also **टिभिया** *tibhiya* in South Munger and **सुरया** *suiya* in South Bhagalpur. To throw out shoots is **अँखुआप्रब** *ankhūāḥb* or **खुआप्रब** *suāḥb*. When the ear begins to show itself the phrase used is **ललन्दात बा** *lalhāt ba* in Shahabad, **रँडा भेल है** *renra bhel hai* in Gaya, **लहलहा राहल है** *lahlaha rahal hai* in Patna, **अड़ा गेल** *ara gel* in South Munger, and **हलन्दाहार है** *hallalāichai* in South Bhagalpur. When the heads are blighted and grainless, they are **थुथा** *thuntha* in South-West Shahabad, **बन्धु** *banjhar* in the rest of that district and in West Tirhut, **बाँड़** *bānr* in Gaya, **थुथा** *thuttha* in Patna, and **मुड़िया** *muriya* in the south-east. The fluffy flowers are **घोंपा** *ghompa* in South-West Shahabad, **जावा** *jāwa* in South Munger, and **फुलको** *phulko* in South Bhagalpur.

CHAPTER VIII.—THE SMALL MILLETS.

988. These are—

- (1) *Panicum Italicum*.—This is **टँगुनी** *tanguni* to the south-west and in Sāran, and **टाँगुन** *tāngun* in Sāran and Gaya. Elsewhere it is **कौनी** *kauni*, or in South Munger optionally **काउन** *kāün*.

989. (2) *Panicum mileaceum*.—साँवाँ *sāñwāñ* or सावाँ *sāwāñ*. In Tirhut it is also सामा *sāma*, and in South Bhagalpur सामा *sama*.
990. (3) *Eleusine coracana*.—This is the most important of all the millets, forming the staple food of a large portion of the population. It is महुआ *marua* or मँहुआ *manrua*. The empty dry ears after the grain has been taken out are डाँटी *dānti* north of the Ganges; also कहुआ *katua* in North-East Tirhut, मोही *morhi* in South-East Tirhut, and पुत्ती *putti* in South-West Tirhut. In South-West Shahabad they are खोलङ्गी *kholri*, and in the rest of that district भूसी *bhūsi*. In Patna and Gaya they are भूसा *bhūsa* or खलकोर्या *khalkōiya*, and in the south-east they are भुसा *bhussa*. The stalks are नेरुआ *nerua* or लेरुआ *lerua* to the west, and लार *lār* to the north-east. Another word current to the north-west is दडा *dhattha*. In Patna they are नार *nār*, in Gaya नारा *nāra*, and in the south-east लरुआ *lurua* or नरुआ *narua*. In Gaya and the west डाँठ *dānth* or डाँट *dānt* or डाँटी *dānti* is also used. The green ears roasted for food are उम्मी *ummi* or उमी *ūmi* to the west and in Tirhut, and उनी *ūni* in Champāran. When cut somewhat riper, but not quite ripe, and then roasted, they are होरहा *horha* generally, and ओरहा *orha* in Tirhut and to the east. They are optionally होलहा *holha* in Champāran and South Munger. In Shahabad they are हाबुस *hābus*, and south of the Ganges generally घुघनी *ghughni* or घुघनी *ghughni*. This being an important food-crop, there are many popular sayings concerning it. The following may be quoted :—

जब महुआ आ के गाही भेल ।
 धिया पुता सुख सुख माखी भेल ॥
 जब महुआ मँ बाल भेल ।
 धिया पुता के गाल भेल ॥

Jab marua a ke gāhhi bhel,
Dhiya puta sukh sukh māchhi bhel.
Jab marua meñ bāl bhel,
Dhiya puta ke gāl bhel.

—When the *marua* began to sprout, the children dried up like flies (*i.e.*, their food had been used for seed-grain); but when the *marua* came in the ear, the children got (fat) checks.

मड़ुआ मीन चीन सङ्ग दही ।
कोदो के भात दूध सङ्ग सही ॥

Marua mīn, chīn sang dahi,
Kodo ke bhāt dūdh sang sahi.

—*Marua* should be taken with fish, *chīna* with tyre, and milk with *kodo*.

कोदो मड़ुआ अन्न नहिँ ।
जोलाहा धुनिया जन नहिँ ॥

Kodo marua an nahīn,
Jolha Dhuniya jan nahīn.

—*Kodo* and *marua* are not really food-grains, (*i.e.* they are despised as poor men's food), just as weavers and cotton-carders can never be cultivators.

991. (4) *Panicum frumentosum*.—This is चिन्ना *chinna* or चीना *chīna*, local variants being चीन *chīn* in East Tirhut and चीन्हा *chīnh* in South-West Shahabad. It is of two kinds in Sāran,—गौरिया *gauriya* and रक्सा *raksa*. The grains when boiled and then parched are called मादा *mārha* or माँदा *mānrha*, or in East Tirhut माड़ *mār*.

992. (5) *Paspalum frumentaceum*—This is कोदो *kodo*. In Shahabad a smaller variety is called कोदर *kodar*.

993. *Miscellaneous*.—मकरा *makra* (*eleusine aegyptica*), a kind of grass of which the seeds are eaten. In the North-Western Provinces this name is applied to *eleusine coracana*, but not in Bihār.

CHAPTER IX.—PULSES.

994. Among the pulses are—

(1) *Cytisus Indicus* or *cajanus*.—This is राहर *rahar* or राहरी *rahrī*. In North-East Tirhut it is also called रैचड़ *raihar*, राहरि *rāhari*, or राहर *rāhar*. The dry stalks are रहेठा *rahetha*

north of the Ganges, or रघाठ *rahāth* or राघठ *rāhath* in East Tirhut. South of the Ganges we have हरेठा *haretha* or ररेठा *raretha* (also used in Tirhut) in South-West Shahabad, रहरेठा *rahretha* in the rest of that district, रहरेठा *rahraitha* in Patna and Gaya, लहरेठा *lahraitha* in South Munger, and लरेठो *laretho* in South Bhagalpur. The pods are डैदी *dhenrhi* generally, and हेमी *chhemi* also north of the Ganges and in Shahabad. To the East they are also चीमड़ि *chīmari* or हिसण्डी *chhimri*. In Gaya they are also चीमी *chhimi*, in Patna डिण्डी *dindi*, and in South Munger डौंड़ी *dūri*. The stalks used for fodder are भूस *bhūs* or भूसा *bhūsa*; also कदुआ *katua* in Patna and कदुओ *katuo* in the south-east. This and other pulses when sprouting are known as डिबी *dibbi* or डौमी *dibhi*, except in the north-east, where they are गाह *gāehh*. Bread made from this pulse, gram (बूँट *būnt*), and *phaseolus mungo* (मुङ्ग *mung*), is called लिट्टी *litti* or रोटी *roti* north of the Ganges (both these words being general terms for bread made from any grain), भभन्ना *bhabhra* in Patna and Gaya, and चितावा *chitāva* in South Munger. बरी *bari* is a kind of round cake or fritters made similarly.

995. (2) *Phaseolus mungo*.—This is मुङ्ग *mung* or मूंग *mūng*. In North-East Tirhut it is also called मँहा मूंग *maūha mūng*. The pods are called the same as those of *cytisis cajanus* (रहर *rahar*). The stalks used for fodder are भेंगन्ना *jhengra* in Sāran, Gaya, and South-West Tirhut, कार *jhār* in Champāran and North-West Tirhut, डाँठ *dānth* in North-East Tirhut, and गाह *gāehh*, भमण्डी *jhamri*, or भाँग *jhāng* in South-East Tirhut. South of the Ganges they are भूस *bhūs* or भूसा *bhūsa*; also कदुआ *katua* in Patna and कदुओ *katuo* in the south-east.
996. (3) *Phaseolus roxburghii* or *phaseolus radiatus*.—This is उरिद *urid* or (south of the Ganges optionally) उरुदी *urdi*. In East Tirhut it is also called कलार *kalāi*, कराह *karāi*, or मास कलार *mās kalāi*. There are several kinds, e.g., डोसा *doma* (East Tirhut), which bears in Pūs and Māgh (January); लरुदी *larhi* (Sāran and South West Tirhut), नरन्हु *narhu*, नरन्हो *narho*, लरन्हो *larho* or असनी *asni* (Tirhut), or अगन्हुआ *aghanua* (Sāran, Cham-

pāran), which bears in *Aghan* (November–December); नेपाली *tepakhi* (Sāran and South-West Tirhut) or कलिका *katika* (elsewhere north of the Ganges), which bears in *Kālik* (October–November); and भद्वी *bhadwi* (South Munger), which bears in *Bhādoñ* (August–September). Another division is into black and green varieties. The black varieties are डङ्गा *dangu* (North-East Tirhut), कारी *kāri*, करिया *kariya* (Shahabad and the south-east), काला *kāla* in Gaya, and सियाह *siyāh* in Patna. The green kinds are तुलबुली *tulbuli* in North-East Tirhut, हरिहर *hariar* in Shahabad, हररा *harra* in Gaya, and सबजी *sabji* in Patna. The pods are डेंही *dhenhi*, चेमी *chemi*, &c., as above.

997. (4) *Phaseolus aconitifolius*.—This has only been noted south of the Ganges. It is generally called मोथ *moth*. A smaller variety is मोथी *molhi*. The stalks used for fodder are भूस *bhūs*, कदवा *katua*, &c., as above.
998. (5) *Errum hirsutum* (one variety) or *cicer* (or *vicia*) *lens* (another variety).—This is मसूर *masūr* or मसुरी *masuri*.
999. (6) *Miscellaneous*.—कुरथी *kurthi* (*lotichos biflorus*), खेसारी *khesāri* (*lathyrus sativa*),* भेंट *bhent* or भेंटवांस *bhent-wāns*, खेत मास *khet mās* or खेत मासु *khet māsu* (North-East Tirhut), which is apparently a variety of *phaseolus radiatus*, भिरंगी *bhirngi* (a kind of wild pulse eaten by the poor), and (Shahabad) लतरी *latri*.

* It is unwholesome for human beings, but bullocks eat it greedily, e.g., in the saying—

तुरक तारी, बैल खेसारी,
बामन आम, कायथ काम.

Turuk tāri, bail khesāri,
Bāman ām, Kāyath kām.

—Toddy is necessary for a Musalmān's happiness, *khesāri* for a bullock's, mangos for a Brahman's, and employment for a Kāyasth's.

CHAPTER X.—PEAS.

1000. Peas (*pisum sativum*) are of various kinds. The large variety is मटर *matar*, or in South-West Shahabad मण्टर *mantar*. A smaller variety is केराव *kerāo*. This is often sown with barley, when the mixed crop is known as जौ केराव *jau kerāi*, &c., see § 959. The principal varieties are कबिली *kabili* (north of the Ganges) or कबन्ली *kabli* (south of it), which is a large white kind. It is also called घेबन्ली *ghebli* in South-East Tirhut. North of the Ganges सुगन्वा *sugwa* is a small green variety. Another kind is known as बजरौरी *bajri* in Champāran. बटुरी *baturi* in Shahabad, and कुसही *kusahi* in Patna, Gaya, and the south-east, is a small black variety. In South Bhagalpur it is called भिठगुरा *bhithgura*. Another variety is दबन्लिया *dabliya* in South-West Shahabad, डबल केराव *dabal kerāo* in the rest of that district, and डबन्ली *dhābli* in Patna.

1001. When the plant first appears above ground, it is called डिभी *dibbi* north of the Ganges and in Shahabad, but in the south-west of the latter district it is डामी *dābhi*. In North-East Tirhut it is also called गाही *gāchhi*. In Gaya and Tirhut it is अंकुरा *ankura*, in Patna and Tirhut अंकुषा *ankhua*, in South Munger कन्सी *kansi*, and in South Bhagalpur गजुर *gajur*. When the pod appears, the phrase is to the north of the Ganges पटा लागत बा *pata लागत ba*, or a similar phrase. In South-East Tirhut they say that the plant is पटाएल *patāēl* or पटरा *patra*. In Shahabad they say it is गदराएल *gadraēl*; in Gaya and South-West Shahabad they say देही लागल है (or बा) *dhenrhi लागल hai* (or *ba*); and in Patna डिन्दी लागल है *dindi लागल hai*. The pod when fully formed is देही *dhenrhi*, चीमी *chhimi*, चेमी *chhemi*, or चिमिरी *chhimri* to the north, and दिन्दी *dindi* to the south. In South Bhagalpur it is देही *dhenri*. The unripe pods are गाद *gād* or गादा *gāda*, and when used to make a pottage they are called बटकर *batkar* in South-West Shahabad. The young shoots are also used for pottage. These are called north of the Ganges साग *sāg* or भाजी *bhāji*, the latter principally to the west. When cooked to a soup it is called परेह *pareh*, and in Patna and Gaya भोर *jhor*. In South Munger they are चन्दा *chanda*, and in South Bhagalpur मटरो साग *matro sāg*. The young shoots cooked with pulse are called दलपैता *dalpaita* in South-West Shahabad, and दलसगा *dalsagga* in Patna, Gaya, Saran, and the south-east.

CHAPTER XI.—GRAM.

1002. Gram (*cicer arietinum*) is बूँट *būnt* generally. It is also called चना *chana* in Saran, बेदाम *bedām* in East Tirhut, and रहिला *rahila** to the west.

1003. नोनी *noni* or खटार *khatāi* is the oxalic acid and acetic acid which form on the leaves. In Shahabad पीयर *piyar* is a kind of which the grain is yellow pointed, and बूँटी *būnti*, or in Patna चनी *chani*, is a smaller variety. Another small variety is बटुरी *baturi* in Shahabad.

1004. The young shoot as it first appears above ground is said to be सुरचारसु *sūāil*. In East Tirhut they say of it सूर फेंकलकैक *sūi phenkalkaik*. The shoot is called दाम *dābh* in South-West Shahabad, and दिब्धी *dibbhi* in the rest of that district. In South Munger it is टिब्धी *tibbhi*, and in South Bhagalpur गजुर *gajur* or सूसा *sūa*. The young leaves used as pot-herbs are known as साग *sāg* or भाजी *bhāji*, the latter principally in the west. The pod is देही *dhehri* generally, also छीमी *chhimi* north of the Ganges. Another name is छीमड़ि *chhimari* or विमड़ि *chhimri* in East Tirhut. In Patna it is डिन्डी *dindi*, and so also in South Munger. In South Bhagalpur it is देही *dhehri*, and in South-East Tirhut optionally डीरी *dūri*. The unripe pods are कचरा *kachra*, and elsewhere कचरी *kachri*. When the gram appears in the pod, the verb used is गदराएब *gadraēb*. The plant is then called in South-West Shahabad पटकी *patki*, and in the rest of that district चटकोचा *chatkoha*. In Gaya the phrase is चिटुरा लागल है *chitura lāgal hai*,

* E.g. in the song—

एहि रहिला के पूरि कचारी
 एहि रहिला के दाल ।
 एहि रहिला के कैलीं खिरवरा,
 बहुत मोटेलेँ गाल ॥

Ehi rahila ke pūri kachauri,
Ehi rahila ke dāl ;
Ehi rahila ke kailiñ khirawara,
Bahut motailen gāl.

—I made this gram into *pūri* (thin bread fried in clarified butter) and cakes into pottage *khirawara* (cakes of rice-flour prepared in hot water), and my cheeks got very fat.

and in Patna चट्टा धरिस है *chatta dharis hai*. The husk of the gram is बलुखा *balukha* in South-East Tirhut; elsewhere it is भुसा *bhussa*, भूसा *bhūsa*, or बूसा *bhūsa*. Gram injured by rain is मरारल *marāil*, in Sāran गलल *galal*. In Tirhut it is मारल गेल *māral gel*. South of the Ganges it is पतलगू *patlagū* or पतलगुसा *patlagūsa*, except in South-West Shahabad, where it is उकन्डा *uktha*, in South Munger दरियागल *dahiyāil*, and in South Bhagalpur दगियाल *dagiyāl*.

CHAPTER XII.—SUGAR-CANE.

1005. Sugar-cane (*saccharum officinarum*) is known generally as जख *ūkh* or जखि *ūkhi*. In Tirhut, Patna, Gaya, and South-East Bihar a more general name is केतारी *ketāri*. In North-East Tirhut it is also known as कुसियार *khusiyār*. Among the varieties are—

कुसियार *kusihār* (south of Ganges), a dwarf hard variety.

केतार (Gaya and the south-east), केतारा *ketāra* (Patna), केवाली *kewāli* (Sāran), केवाही *kewāhi* (Shahabad), रौंदा *raunda* (South Munger), a tall thin variety. Ripens in *Kātik* (October–November).

केवाही *kewāhi*,—see केतार *ketār*.

चिनिया *chiniya* or चिनियाँ *chiniyān*, which is a soft, large, whitish cane. Good for eating in *Phāgun* or *Chait* (March). It is called पनसारी *pansāri* in Gaya and Shahabad, पनसाही *pansāhi* in Sāran, and also पनहाही *panchhāhi* or पंसहिया *pansahiya* in the south-west of that district and in West Tirhut. In South Bhagalpur it is called पौंड़ी *paunri*.

नरगोरी *nargori* (North Bihar),—see बरौंखी *baraunkhi*.

पक्षियारी *pachhiyāri*,—see पौंदा *ponrha*.

पनहाही *panchhāhi*, पनसारी *pansāri*, पनसाही *pansāhi*,—see चिनिया *chiniya*.

पौंदा *ponrha* (west), पौंड़ा *ponra* (Patna and Gaya), पक्षियारी *pachhiyāri* (South Bhagalpur), a tall, stout, juicy variety.

पौंड़ी *paunri*,—see चिनिया *chiniya*.

बरौंखी *baraunkhi* (Sāran), बर जख *bar ūkh* (South-West Tirhut), or नरगोरी *nargori* (North Bihar generally). This is thin, with a reddish bark. The juice is sweet and thick.

भुरली *bhurli* (North-West Bihār and West Tirhut), a very thick short cane, full of juice. Fit for eating in *Baisākh* (April-May).

मनमो *mango*,—a small, hard, red cane.

रँवन्डा *renura* (North-West Bihār and South-West Shahabad) or सकरचीनी *sakarchini* (Patna and Gaya),—a yellowish kind, not good for eating.

रौंदा *raunda*,—see केतार *ketār*.

लखगौड़ी *lalgouri*,—a tall, red variety.

सकरचीनी *sakarchini*,—see रँवन्डा *renura*.

साही *sāhi* (South-West Tirhut),—a dwarf variety.

हथुनी *hathuni* (Sāran and West Tirhut),—a moderately thick variety.

1006. A cane-field is to the west उखँव *ukhāw* or उखारी *ukhāri*. Elsewhere it is simply उख (or केतारी) के खेत *ukh (or ketāri) ke khet*. Sugarcane land requires careful cultivation, or, as the saying runs, तीन पटावन, तेरह कोड़न *tin patāvan, terah koran*,—three waterings, thirteen hoeings. Land prepared for sugar-cane is उखँव *ukhāw* in North-West Bihār. When the land is left fallow the autumn preceding the planting, the plant is called पोड़ा *porha* in the North-West and in South-West Tirhut, and सुंगार *sungār* in North-West Tirhut. When an autumn crop is taken the season before planting the cane, the system is known as जरी *jari* to the west, or in Sāran नारी *nāri*. In North-West Tirhut it is called दोतुरा *dotura*. South of the Ganges it is generally called चौमास *chaumās*. When cane is cultivated without irrigation, a layer of leaves, grass, &c., is thrown over the seed and acts as a sort of hotbed. This system is known as खदियाखोल *khadiyākhōl* to the west and in South-West Tirhut, and गोआ पटाव *gou patāv* in North-West Tirhut. To the west two ploughs are used in cane-planting. The first is simply called हर *har* or पहिया वाला हर *phaiya wāla har*; the second is called कान्ही के हर *kānhi ke har* in Sāran and भठौनी *bhatūni* in Champāran. The second plough has a bundle of grass tied round it, called कान्ही *kānhi* or कान्नी *kānni*, to widen the furrow. The furrow is everywhere सिरावर *sirāūr*, also रेह *reh* in North-East Tirhut. South of the Ganges a second plough is not used. In Āzamghar the furrow is filled up by ploughing a second furrow alongside it, but in Bihār this is usually done by hand.

1007. The first watering of the cane is गण्डा धार *ganda dhār* in Gaya and South-West Shahabad; in the rest of Shahabad it is रँवन्डा

chheneka. In Patna it is पनगण्डा *panganda*, and in South Bhagalpur अँधन्री पटावन *andhri patāwan*. Elsewhere it is simply पहिल पटावन *pahil patāwan*. The second watering is क़ोड़ा *kora* in Patna. Elsewhere it is दोसर पटावन or (पानी) *dosar patāwan* (or *pāni*), with a variant दोसरो पटावन *dosro patāwan* in South Bhagalpur. The third watering is आँखन्री *ākhrī* in Patna; elsewhere. तेसर (or तेसरो in South Bhagalpur) पटावन (or पानी) *tesar* (or *tesro*) *patāwan* (or *pāni*).

1008. Cane sprouting from the roots left since the previous season is known as खूँटी *khūntī* north of the Ganges, and also कुँटिया *khuntiya* in North-East Tirhut. When sprung from fresh seed it is known as बावग *bāwag*, or (optionally) in Tirhut रोप *rop*. Cane sown after the autumn crop is cut is known as जरिया के जख *jariya ke ūkh* to the west, and also नारी के जख *nāri ke ūkh* in Sāran. In South-West Tirhut it is दोतुरा के जख *dotura ke ūkh*. Elsewhere it is known as चौमसिया *chaumusiya*. Cane cut up for seed is known as गेंड़ा *genra* or गेंड़ी *genri* to the west, and टोना *tona* or टोनी *toni* to the east. गुल्लो *gulli* is also used in Shahabad. In Patna it is also called पौँचड़ा *pouhṛa*, and in South Bhagalpur बीहन *bihan*. When only the top of the cane (which sprouts quicker than the rest) is cut up for seed, the pieces are called अँगेर *anger* in Sāran, अँगेरा *angenra* in Gaya, अगारी *agāri* in Patna, अग्रा *agra* in South Munger, and आगा *āga* in South Bhagalpur. North of the Ganges they are called बधिया *badhiya* or (in North-West Tirhut) फुनगी *phungi*. The hole in which the cane slips are kept before planting is खाद *khād* in Sāran, खाना *khāna* in Champāran, गाड़ा *gāra* in Shahabad, गेंड़मार *ganrsār* in Gaya, बलसार *balsār* in Patna, and टोनखाद *tonkhād* or टोनखावा *tonkhāwa* in the south-east.

1009 The sprouting eyes of the cane are आँखि *ānkhī* or आँख *ānkh* in Gaya and to the west generally; so also in South Munger. In North Tirhut they are अँखिया *ankhiya*, and in South-West Shahabad अँखवा *ankhwa*. In Patna and East Tirhut they are अँखुआ *ankhwa*, and in South Bhagalpur अँखियाय *ankhiyāy*. When just sprouted, the cane is called पुआड़ी *puāri* in Champāran, पौरी *paūri* in South-West Tirhut, and गोभी *gobhī* elsewhere north of the Ganges. In Shahabad it is called पोर *poi*, in Gaya it is said to be अँकुराएल *ankurāēl*, in Patna अँखुआएल *ankhuāēl*, and in Sāran सुरयाएल *suiyāēl*. In South Munger it is टिब्बी *tibbhi*, and in South Bhagalpur डिफी *diphī*. The earth is hoed (कोड़ल *korāl*) once after the cane has sprouted. This is called पुआरी के जोत *puāri ke jot* in Champāran, and अन्हरिया *anhariya* in North-East Tirhut. Elsewhere it has no special name. The chief

hoeing is done in *Akhārkh* (June-July), and is called **बसादी कोड़** *akhārhi koran* or **बदरा के कोड़नी** *adra ke korni*. To the west it is called **बसादी कोड़** *asārhi kor*, and in Gaya it is **पासा** *pāsa*.

1010. The root is **जड़** or **जर** *jar* to the north-east, and **मूढ़** *mūrk* elsewhere north of the Ganges. In Shahabad it is **जड़ खर** *jar khar*, in Gaya and South Bhagalpur **खूँटी** *khūnti* or **खूँटिया** *khūntiya*, and in Patna and South Munger **जड़ी** *jarī* or **जड़िया** *jarīya*. When the sprouts are two or three feet high, they are called **टोंटा** *tonta* in Patna. Elsewhere they have no special name: the plant is simply described as **भर ठंडना** *bhar thebna*, or in some similar way. The knots on the cane are **पोर** *por*, and (in Shahabad) **पोद** *pōi*. They are also called **गिरे** *gire* or **गिरेह** *girch*. When these become visible, the plant is called **पोराना** *porāna* in Champāran, Patna, Gaya, and the east generally. In West Tirhut they are **गिहाना** *girhāna*, and in South-East Tirhut **पोर चोरना** *por chorna*. In Shahabad they are called **ढँडौका** *denrauka*. When the plant is ready for cutting, it is called **अगरबन्धु** *agarbandhu* in Patna and **अंगेरबन्धु** *angerbandhu* in Gaya. In the south-east it is **डाँड़** *dānr*. Elsewhere it has no special name. A sprout of cane is **आँख** *ānk* north of the Ganges and in Shahabad and Gaya. In North Tirhut it is **अँखिया** *ankhiya*, in Patna **अँखुआ** *ankhua*, in South Munger **कनसी** *kansi*, and in South Bhagalpur **गोंजी** *gonji*. The leaves at the top and the upper part of the cane are **अगेंड़** *agenr* in the west, and **गेंड़** *genr* in the south-west of Shahabad. In Patna and Gaya they are **अंगेरी** *angeri*, and also **अगरा** *agra* in the latter district. In Tirhut they are **पगार** *pagār*, in East Tirhut **छीप** *chhip*, and in the south-east **पगड़ा** *pagra*. The dry leaves at the top are **पतैन** *patain* in Sāran and South-East Tirhut, **पतन्हर** *pathar* in Champāran and North-West Tirhut, **पतलो** *patlo* in South-West Tirhut, and **पतरस** *patras* in North-East Tirhut. In Shahabad they are **पतई** *patāi*, in Gaya **पतौरा** *patāura*, in Patna **पतन्हूल** *pathūl*, in South Munger **पतौरा** *patāura* or **पतन्होल** *pathol*, and in South Bhagalpur **पलन्होर** *pathor*. Shoots coming from the knots are **कनगोजर** *kangajar* or **कनोजर** *kanajar* in South-East Tirhut.

1011. A branch springing from the bottom and injuring the plant is **दोंज** *donj* in Sāran and South-West Tirhut, **पख्खी** *pachhki* in Champāran, **फुटना** *phutna* in North-West Tirhut, and **गोभी** *gobhi* in East Tirhut. In South-West Shahabad it is **कनखी** *kankhi*, and in the rest of that district **गँवखा** *ganukha*. In Patna and Gaya it is **जोंका** *jonka*, and in the south-east **पगुड़ी** *paguri*. In South Bhagalpur

it is also पञ्च *pahunch* or पोर्नोवो *pornovo*. When a plant is attacked by insects, which are called in Sāran and Champāran सीना *sina* or ताड़ा *tāra*, it is called north of the Ganges कनाइल *kanāil* or रतङ्क *ratral*, or (in Tirhut) कनाह *kanāh*. The latter name is also current in South-West Shahabad, and variants are कनाहा *kanāha* in South Munger, कानो *kāno* in South Bhagalpur, and काना *kāna* in Patna. In Gaya it is called रसाप्रल *ratāel*, and another term in use in Patna is रसाप्रल *rasāel*. North of the Ganges a plant is called मुड़ियारी मारल *muriyāri mārāl* when the top withers and fresh sprouts (टेनी *teni* in Sāran and दौंजी *donji* in Tirhut) come out from underneath.

1012. The green top cut for fodder is अगैड़ *agenr* or अंगेर *anger* in Sāran, गैड़ *genr* in Champāran and Shahabad, अंगेरी *angeri* in Patna and Gaya, and also अगर्रा *agra* in the latter district, and अगाड़ *agār* in South Munger. In Tirhut it is पगार *pagār*, and in South Bhagalpur पगड़ा *pagra*. The piece between two knots cut for eating is पोer *por*. The piece of cane chewed at one time is गुला *gulla*, or (in Shahabad) optionally गुली *gulli*, and the refuse thrown out of the mouth खोदिया *khoyia* north of the Ganges. South of the Ganges it is generally खोदिया *khohiya* or चेषुआ *chepua*, local names being सिद्धी *sitti* in Shahabad and South Munger, (also used in West Tirhut) and चोपा *chopa* in South Bhagalpur. For the pieces of cane cut for the sugar-mill, see § 288.

1013. A bundle of canes is पाँजा *pānja*. A large bundle is बोजा *bojha*, which is as much as can be carried by a man.

1014. Among the *preparations of the sugar-cane* may be mentioned रस *ras*, or कचरस *kachras*, and in South Bhagalpur कचो रस *kanchho ras*, which is the juice of the cane. When boiled down and undrained, it is राब *rāb* or (in Patna and Gaya) रावा *rāwa*. When boiled down for a longer time, it becomes गुर *gur* or गूर *gūr* (often spelt गुड़, गूड़). When made up in smallish balls it is called भेली *bheli*. Other names are मिठार *mithāi*, and, when made round and flat, चाकी *chāki* and चकरी *chakri* in Sāran, and चकी *chukki* in Patna and Gaya. The raw sugar which remains in the bag after pressing the *rāb* is called सक्कर *sakkar*, or in Patna, Gaya, and the south-east सक्कर *sankar*. When dried, it is called खँड़ *khānr* or खुर्रा *bhurra* or भूरा *bhūra*, i.e. brown sugar. The molasses, or juice which runs out of the bag when the *rāb* is pressed, is called खोआ *chhoa*, or in South-West Shahabad सिरा *sira*. मिसर्री *misri* is sugar-candy or loaf-sugar, and चिन्नी *chinni* or चीनी *chini* is refined brown sugar (सक्कर *sakkar* or गूरा *bhūra*). The molasses (खोआ *chhoa*) above

mentioned is used in tobacco manufacture, and is then called तगार *tugār* in Gaya, गरिया *gariya* in Patna, and फाँक *phānk* in South Bhagalpur.

1015. In a sugar-refinery रस *ras* (or in the north-west सरन्वत *sarbat*) is the raw sugar dissolved in water. मैल *mail* is the scum taken off the boiling-pans. To the south-east this is मैला *maila*, and in North-West Tirhut and Shahabad महिया *mahiya*. The boiled juice is सीरा *sira*, and the clear filtered juice रास के रस *rās ke ras*. To the north-west the juice after the first filtering is दोमा *doma*, and after the second ठोपारी *thopāri*. When the scum is mixed with water and again boiled, it is called पसावा *pasāwa*.

CHAPTER XIII.—COTTON.

1016. The cotton-tree (*gossypium herbaceum*) is known everywhere except to the south-west as बङ्गा *bānga* or बाँगा *bānga*, with a local variant बाँगे *bāngo* in South Bhagalpur. To the west it is called कपास *kapās*, which properly means the cotton in the pod. Most kinds of cotton ripen about *Baisākh* (April-May). Amongst the varieties may be noted भोगिला *bhogila* (north of the Ganges), a good kind with large pods, and of medium height; भोचरी *bhochri* (north of Ganges), a small variety, of which the cotton is apt to get blown out of the pod by the wind. फेटवाल *phetwāl* is a kind grown in North-West Tirhut, and गाजर *gājar* is one grown close to the house in the बारी *bāri*, and not in the fields, in North-East Tirhut and Shahabad; रहिया *rarhiya* (Patna, Gaya, and the south-west), a dwarf variety; बड़ैया *baraisa* (Patna and Gaya), a large variety; लरन्मा *larma* (Sāran), नरन्मा *narma* and हँवन्ती *henuti* (Shahabad), a dwarf variety. Other kinds grown in Shahabad are बाँरुछा *bāñrūccha* or बाँरुछा *bāñrūccha*, and मनवाँ *manwān*, and in Munger we find गोला *gola* and सुफेद *sufhed*. Tirhut is famous for a special kind of cotton which ripens in *Bhādoñ* (August-September), called कोकटी *kokti* or भदैया *bhadaiya*, which is of a red colour, and of which thread and cloth of extreme fineness are made. A dress of *kokti* cloth lasts a life-time.

1017. The uncleaned cotton in the pod is कपास *kapās*, also बाँगा *bānga* in East Tirhut, बाँगे *bāngo* in South Bhagalpur, and काँच रुखा *kāñch rūa* in South Munger. To clean the seeds from cotton is ओटाव *otab* or ओँटाव *ontab*, and the operation is called

चोटनी *otni* or चोटार *otāi* in Saran, and चोटार *auntāi* in South Bhagalpur. The last two words also mean the wages paid for cleaning. The cotton-pod is called डँह *dhenrh* to the north-west and डँही *dhenrhi* in Tirhut and South Bhagalpur. In Shahabad it is डँही *dhorrhi*, in Gaya डेर *ter*, in Patna and South Munger डिण्डी *dindi* or डँडी *dinri*. The cotton-seed is बनौर *banaur* to the west, बँगौर *bangaur* in Tirhut, बँगौरा *bangaura* in South Munger, and बँगठी *bangthi* in South Bhagalpur. In South-West Shahabad it is बँदौर *bandaur*. A cotton-picker is लोहन्निहार *lorhnihar* (which means simply 'gatherer') in the north-west; elsewhere there is no special name. North of the Ganges he or she is paid by a share of the cotton picked. This is called परं *pari* in Saran and South-West Tirhut, पोइ *poi* in South-East Tirhut, and बोइन *boin* in North-East Tirhut. In North-West Tirhut the share is a fourth of the crop, and is called चौठैया *chauthaiya*.

1018. The stages of growth in the plant are as follows:—

When the first leaf shows, it is called पतियाग्रल *patiyāēl* north of the Ganges. In South-West Shahabad it is डुब्बी *dubbi*, in the rest of that district डिब्बी *dibbi*, and in Patna and Gaya कनियाग्रल *kaniyāēl*.

The next stage is दोपतिया *dopatiya* to the north-west, and also south of the Ganges generally. In Tirhut they say it is कपारी फोरल *kapāri phoral*. In Gaya it is पतिया *patiya*, in South Munger दोपची *dopatti*, and in South Bhagalpur दुपतियो *dupatiyo*.

The third stage is चौपतिया *chaupatiya* or (to the north) चरन्पतिया *charpatiya*, and in South Bhagalpur चरन्पतियो *charpatiyo*.

The flower has no special name, and is simply called फूल *phul*. To flower is फुलाग्रब *phulāēb*.

The pod bursting is कपास फूटब *kapās phūtab* to the west, and in East Tirhut बाँग फूटब *bānga phūtab*. In South Bhagalpur it is बाँगो फूटब *bāngo phūtab*, and in South Munger फोटा *phota*.

1019. Raw cotton is कपास *kapās*, or बाँग *bānga*, बाँगो *bāngo*, &c., as above. In East Tirhut बाँग *bāng* is also used. To the west बाँग *bānga* means cotton stalks. From रदिया *rarhiya* (raw cotton) about one-sixth clean cotton is obtained; from भोचरी *bhochri* and कोकटो *kokti*, about a quarter; from भोगिला *bhogila* and हँवन्ती *hemcti*, about a third; and from फेटवाल *phetwāl*, about two-fifths. मिह्रा *mijhra* north of the Ganges is a mixture of भोचरी *bhochri* and भोगिला *bhogila*.

1020. Cotton is the subject of many proverbs, as (for instance) South Munger proverb जेकरा बारह विगन्हा बाँग, कसर में डोरो ना, *jekra*

bārah bigha bāng, kamar meñ doro na—(here's a fine miser) he has twelve *bighas* of cotton and can't afford a string for his waist.

CHAPTER XIV.—TOBACCO.

1021. Tobacco (*nicotiana tabacum*) is तमाकू *tamāku* or तमाकुल *tamākul*. It is little grown south of the Ganges except in South-Bhagalpur and South Munger. North of the Ganges there are three main classes :—

- (1) देशी *desi* or (North-East Tirhut) बड़की *barki*.
- (2) बिलापती *bilāēti* or (in Champāran and North-West Tirhut) कलकतिया *kalkatiya*.
- (3) जेठुआ *jethua*, which is sown in *Māgh* (January–February) and cut in *Jeth* (May–June).

In East Bihār are found धमाकुल *dhamākul*, a broad-leaved variety, and पनडडिया *pandathiya* and खंगड़ीया *khangrīya*, narrow-leaved varieties.

1022. In Shahabad मोरहन *morhan* are long leaves of the best kind, and छेउआ *chheua* the next quality.

1023. When manufactured, there are three main kinds :—

- (a) *Chewing-tobacco*.—खैनी *khaini* or सुरती *surti*, or in Patna दोखन्ता *dokhta*. Some people call this कल जुग के अमृत *kal jug ke amrit*, or the ambrosia of the *kali* age.
- (b) *Snuff*, which is नास *nās* or नस *nas*.
- (c) *Smoking-tobacco*.—This is called पीपनि *pīani* or पीनी *pīni* generally. Among its kinds may be noticed काला *kāla* (North-West and South-East Tirhut) or पकुआ *pakua* (Tirhut), which is the coarsest kind. कन्दर *kandar* or भुसना *bhusna* in South Bhagalpur, and गूड़ी *gūri* in South Munger, is broken tobacco. कडुआ *karua* or (in South Bhagalpur) कडुओ *karuo* is a second-class strong kind. दोरसा *dorassa*, or in South Bhagalpur दोरसो *dorasso*, is a mixed tobacco of fair quality. Another similar kind is called मसालन्दार *masāldār* or महकौआ *mahkaua*. खमीरा *khamīra* is a scented kind mixed with spices, and सादा *sāda* is the plain kind in common use. मलुआ *malua* to the west is the usual kind sold in

shops, and **दोकानी** *dokani* is the cheap kind used by the poor.

1024. The stalks are **डहली** *danti* generally, with local variants **डँट** *dānt* in South Munger and **डँटकी** *dantki* in South Bhagalpur. In East Tirhut they are also **डँट** *dānth*. The refuse broken leaves and stalks are **झाला** *jhāla* in the south-east, and in South-East Tirhut **खरसान** *kharsān*. When blisters come on the leaf when ripe, the verb used is **चढ़ब** *charhab*; also **गुलठियाप्रब** *gulthiyāēb* or **चितियाप्रब** *chitiyāēb* in Champāran. The blisters themselves are called **चिची** *chitti*. The seed-capsules are **घुनी** *ghūni* in Sāran, **फर** *phar* in Champāran, and **बिची** *bichhi* in Tirhut generally. The nipping or cutting off of the head is **पता तूरब** *pata tūrab* in Sāran and South-West Tirhut, **छोपनी** *chhopni* in South-East Tirhut, and **काटब** *kātab* or **कटनी** *katni* elsewhere. Sometimes shoots appear after doing this, and they are called **दोंजी** *donji*. Other local names are **पचखी** *pachkhi* in Sāran and Champāran, **कनोजर** *kanojar* in North-East Tirhut, **कनैल** *kanail* or **कान्खी** *kānkhi* in South Tirhut, and **कनई** *kanai* in the east generally. The first crop is called **मोरहन** *morhan*. A second crop raised from the roots is **दोंजी** *donji*, or in South Bhagalpur **खुंटिया** *khuntiya*. Tobacco seedlings are called **पोचा** *poa* in South Bhagalpur.

1025. Tobacco is the subject of many proverbs and tales. An example of the former is—

चुन तमाकु चान के, बिन माँगे जे दे ।
 सुरपुर नरपुर नागपुर, तीनु बस कर ले ॥
Chūn tamāku sān ke bin mānge je de,
Surpur narpur nāgpur, tīnu bas kar le.

—The man who mixes tobacco with lime (for chewing) and offers it without being asked, conquers (by his virtuous action) heaven, earth, and the lower regions.

1026. A folk-tale about tobacco runs that a villager who went to a distant village to visit his friends found them smoking in the morning before they had said prayers, whereupon he said—

भोर भए मनुस सब जागे ।
 ऊका चिलम बाजन लागे ॥
Bhor bhac, manus sabh jāge,
Hukka chilam bājan lage.

—At daybreak the people awoke, and immediately the *hukkas* began to gurgle.

To which one of the smoking party replied—

खैनी खार नः तमाकु पीए ।

से नर बनावन कैसे जीए ॥

Khaini khāe, na tamāku piē,

Se nar batāwa kaise jiē.

—Show me the man who can live without either chewing or smoking tobacco. This verse has passed into a proverb.

1027. Tobacco is often compared to the river Ganges, which has three streams,—one of which flows to heaven, another to hell, and the third to the world of mortals. So also tobacco has three branches, viz. snuff, which, by being smelt, goes upwards; smoking-tobacco, which, by being smoked, goes downwards; and chewing-tobacco, which goes neither up nor down.

CHAPTER XV.—OPIUM POPPY.

1028. Opium poppy (*papaver somniferum*) is पोसना *posta* or (in Patna) पोसन *posat*. The advances made to the cultivators are दादनी *dādni*. The average produce per *bigha* is सरन्दर परन्तर *sardar partar* or परना *parta* north of the Ganges and in Gaya. In Shahabad it is माल *māl*, and in Patna पैदा *paida*. The rough measurement of the field is लठाबन्दी *lathābandi* in South-West Shahabad, and elsewhere south of the Ganges नाप *nāp*. North of the Ganges it is नापी *nāpi*.

1029. The poppy petals are फूल *phūl*, and the heads देही *dehī*, or in Patna डिण्डी *dindi*. The cakes of poppy petals are फुलपता *phulpata* in Champāran, फुलपत्ती *phulpatti* in Sāran and Tirhut, and पत्तल *puttal* in Patna. Elsewhere they are रोटी *roti*.

1030. The instrument used for piercing the capsule is नहरणी *naharni*, or in Tirhut optionally लहरणी *laharni*. In Patna and Gaya it is नरन्हनी *narhanni*. To lance the capsule is पाखव *pāchhab*. The milky juice which exudes is दूध *dūth*, and the opium yield is माल *māl*. The scraper used for collecting the coagulated opium off the pod is called सिनुचा *situcha* or सिनुचा *situa*. In South-East Tirhut sometimes a bamboo scraper is used, called पोखनी *pochhni*. The gathering of opium is उठाव *uthāēb* generally. Local words are काखव *kāchhab* to the north-west and in North-West Tirhut, and पोखव *pochhab*

also in North-West Tirhut. The person who lances the capsules is **पक्ष्मिहार** *pachmihār* or (*fem.*) **पक्ष्मिहारिन** *pachmihārīn*, and he or she who collects the coagulated opium which has exuded from the capsule is **उठौनिहार** *uthaunihār* or **उठौनिहारिन** *uthaunihārīn*. The grain of the prepared opium is **दाना** *dāna*, and its consistency **सुखन्वन** *sukhwan*.

1031. The grains of opium-seed are **दाना** *dāna*. The shell is **खोइया** *khoiya* north of the Ganges, and **खोइया** *khohiya* in Gaya. In South-West Shahabad it is **खोलन्डी** *kholnī*, in the rest of that district and in South-East Bihar **बोकला** *bokla*, and in Patna **बकुला** *bakula*. In Gaya **चिटुरा** *chitūra* are poppy capsules which are empty and have not borne seeds. The oil-cake prepared from the seeds is **पिन्ना** *pinna* or **पीना** *pīna*.

1032. The refuse opium, consisting of the washing of the vessels, &c., is **धोअन** *dhoan* north of the Ganges and **धोई** *dhoī* south of it. In the south-east it is **धोए** *dhoē*. The refuse scraped from the vessels is **खुरचन** *khurchan*, or (Gaya, South-West Shahabad, and South Munger) **खखोरन** *khakhoran*. The juice which drains off the fresh opium is **पसेवा** *paseva*. This is inspissated on rags, and the product is **कफा** *kapha*, of which **काफा** *kāpha* in Shahabad and **कप्पा** *kappha* in Sāran and South Munger are local variants. The fluid opium used in pasting the leaves on the cakes is **लेवा** *lewa* in Patna, and the cakes themselves are **गोटी** *gotī*.

1033. *Preparations of opium.*—**मदक** *madak* is made by boiling down and inspissating the juice (**अरख** *arakh*) of pure opium or **कफा** *kapha*. This inspissated juice is known as **किमास** *kimām* or (in Gaya) **केमास** *kemām*. With it are mixed cut-up betel or guava leaves, known as **जासू** *jāsu*. The pipe used for smoking *madak* is known as **महुरू** *mahrū* or **ठरिया** *thariya* or **ठरिया** *tharhiya*, or to the south-east **मेरू** *merū*. A small piece of *madak*, known as **छीटा** *chhīta*, is ignited in the bowl of the pipe with a spill of charcoal, called **कलम** *kalam* or (in South Bhagalpur) **कंगड़ा** *kangra*, which is held by a small pair of tongs, called **चिमटा** *chimta* in the north-west and **चूटी** *chūntī* south of the Ganges.

1034. **चण्डू** *chāndū* or **चाँडू** *chāndū* is the distilled juice of pure opium, and is smoked in an earthen bowl called **चिलम** *chilam* to the north-west and **दवान** *dawāt* south of the Ganges. This is attached to a stem called **निगाली** *nigālī* in Sāran, Patna, and Gaya, **नरचा** *narcha* in Champāran, and **नर** *nar* in North-West Tirhut. Another name is **बम्बू** *bambū* or **बाँबू** *bāmbū*, bamboo. It is stirred with an iron skewer, called **थक** *thak*.

When it is desired to make the preparation extra strong, the sediment which accumulates in the stem of the pipe is added. This is called **अँची** *anchi* south of the Ganges generally, **इन्सी** *insi* in South Munger, and **इँची** *inchi* in South Bhagalpur. In Patna it is also called **कैटी** *kaiti*, and in Champāran **कैटी** *kaiti*.

1035. **पिनिक** *pinik* is the drowsiness produced by opium intoxication, and **चुसकी** *chuski* the quantity of opium water drunk at one time.

CHAPTER XVI.—HEMP.

1036. The hemp plant (*cannabis sativa*) is known as **गँजा** *gānja* when cultivated in Rajshahai, and **भँग** *bhāng* when wild elsewhere. The leaves are known as **भँग** *bhāng* or **भङ्ग** *bhang* (generally), **सबुजी** *sabuji* (north-west), or **सबजा** *sabja* (Patna and Gaya). A favourite way of taking the drug is in the form of a sweetmeat, called **मजूम** *mājūm* or **माजूम** *mājūm*. **चरस** *charas* is the resin which exudes from the flowers and leaves.

1037. The flat *gānja* is **चपन्टा** *chapta* or **चिपन्टा** *chipta*; also in Shahabad **कली** *kali*. The round *gānja* is **गोल** *gol*, also **गिरगिटिया** *girgitiya* in South-West Shahabad, and also **पमड़ी** *pamri* in the rest of that district. Broken *gānja* is **रोरा** *rora* or **चूर** *chūr*, or (in Gaya and South Munger) **रई** *rai*. In Shahabad **बालूचर** *bālūchar* and **जासर** *jāsar* are two kinds of imported *gānja*. *Gānja* with stalks attached is called **दाही** *dāhi* in Shahabad. **मेदनि** *medani* or **मेदनी** *medni* is a plant taken with *gānja*.

CHAPTER XVII.—INDIGO.

1038. Indigo (*indigofera tinctoria*) is **नील** *nīl*. The word *nīl* used by Europeans is a Westernism borrowed from Ūrdu-knowing subordinates.

1039. Indigo sown before the rains and irrigated by artificial means is called **पटौचा** *patana*. The first cutting is **मोरहन** *morhan*. The second cutting is **खूँटी** *khūnti* or (in South-East Tirhut) **दोंजी** *donji*, and the third cutting is called **तेँजी** *tenji* or **तेलरी** *telri*, or in the north-west **तिराँटी** *tirānti*. If the second or third cutting is allowed to grow on to the second year it is called **कलम** *kalam* or **कलनी** *kalni*. In South Bhagalpur there are two sowings (**बावग** *bāwag*),—one called **कतिकी**

katiki (कानिक *Kātik* = October–November), and the other फाल्गुनी *phalguni* (फाल्गुन *Phālgun* = February–March). In North Bihār the chief sowing is the फगुनी *phaguni* (फागुन *Phāgun* = February–March), and there is a second sowing in अखाढ़ *Akhārḥ* (June–July), called असाढ़ी *asārhi* or अखाढ़ी *akhārhi*. There are also sowings in कानिक *Kātik* (October–November) and बैसाख *Baisākh* (April–May).

1040. The system of obtaining the plant from cultivators on advances is called दादनी *dādni* or दादन *dādan* in the north-west, in South-West Tirhut, and in South Bhagalpur. When indigo is grown by cultivators who have entered into an agreement to do so, it is called रैयनी *raiyni* or असामिवार *asāmiwār* or असामियार *asāmiyār*. Under the system called in the north-west खुश खरीद *khush kharīd*, the planter advances money to a cultivator to sow indigo. He also advances indigo-seed at a given rate, the price of which is recovered in the settlement of accounts. This is also called खुशकी *khushi* in Champāran and नविशतखानी *nawishtakhāni* in North-West Tirhut. ठीका के लील *thika ke lil* is when the planter takes a village in farm and cultivates the *zira'ats* (जिरात *jirāt*) and such other land as he can secure. The special cultivation carried out by the planters themselves is जिरात *jirāt*, or (in South Bhagalpur) बाड़ी *bāri*. The divisions of their estates are called जिला *jila*, each under charge of a जिलादार *jilādār*, and a subdivision is (north of the Ganges) टोक *tōk*, under charge of a टोकदार *tōkdār*.

1041. अलावा *alāwa* or अलावे *alāwe* is indigo grown by the cultivator on his land after opium or other crop.

CHAPTER XVIII.—OTHER DYES.

1042. The following may be noted:—

- (1) बाल *āl* (*morinda citrifolia*).—This is used for dyeing red cotton cloth सालू *sālu* and the coarse red cloth खारुआँ *khāruān*. The root is divided into classes, called बाना *bāna*. The best and thinnest roots are known as फूहा *phūha*. The thickest roots are कचरी *kachri* in Shahabad and South Munger, and तोड़न *toran* or गुल्ली *gulli* in Patna and Gaya. मेल *mel* in Shahabad is a mixture of the two kinds.

1043. (2) *Safflower* (*carthamus tinctorius*).—This is कुसुम *kusum* generally north of the Ganges, and कोसुम *kosum* south

of it. A local name is फूल *phul* in Tirhut. The seed is बररी *barri* in South Munger. It is also called to the west and in Patna and Gaya बररे *barre*. The following are some of the colours prepared from safflower:—

असमानी *asmāni*, light blue.

कागी *kāgī*, navy blue.

काला *kāla*, black.

काहि सबुजा *kāhi sabuja*, dark green.

केसरिया *kesariya*, saffron-yellow.

गुलाब *gulāb* or गुलाबी *gulābī*, pink.

चंपई *champaī*, orange.

नारङ्गी *nāraṅgī*, orange yellow.

पैठानी *paithāni*. Made by dipping into an indigo-vat also.

फाल्गुनी *phālgūni*, plum-coloured.

बदामी *badāmi* or बेदामी *bedāmi*, almond-coloured.

बैंगनी *baingni*, purple.

मासी *māsi*, a very dark green.

लाल *lāl*, red.

लीला *līla*, dark blue.

सबुजा *sabuja*, green.

सुरमई *surmaī*, antimony-black.

सुरुख *surukh*, red.

सोनहला *sonāhula*, golden yellow.

Of course all the above are not made from safflower alone, but it forms the basis of all. In most of the darker colours it is used in conjunction with indigo. The following riddle shows the comprehensive range of colours embraced by safflower. At a marriage procession garments of every bright colour are worn, and the riddle is—

बाप रहल पेटे, पूत गेल बरियात.

Bāp rahal pete, pūt gel bariyāt.

—While the father was still in the womb (*i.e.*, pod), the son went to a wedding party. The father is the seed of the safflower in pod; the son is the safflower dye.

In the north-west जववा तेल *jurua tel* is an oil extracted by means of heat from the safflower-seeds. It is called जरववा तेल *jarathua tel*, and in Shahabad डहुवा तेल *darhua tel*. It is used for applying to sores, and also for burning.

1044. (3) बकम *bakam* (*cœsalpina sappan*).—This is a red dye, used principally where आल *āl* is not obtainable.

CHAPTER XIX.—OILSEEDS.

1045. Oilseeds in general are चिकन्ना *chikna*, तेलहन तीसी *telhan tisi*, or simply तेलहन *telhan*. Amongst the varieties may be noted—

- (1) *Mustard* (*brassica campestris* or *sinapis dichotoma*).—This is सरिषों *sarison* or सरिषो *sariso* north of the Ganges and in the south-west; elsewhere it is सरसों *sarson*. In South Bhagalpur it is गोटे *goto*, and in North-East Tirhut also गोटे *got*. Oil from this seed is called करवा तेल *karua tel* or करू तेल *karu tel*.
- (2) *Mustard* (*brassica juncea* or *sinapis ramosa*).—This is लाही *lāhi* or राइ *rāi* to the west. In South Munger it is रची *ranchi*, and in East Tirhut रैची *rainchi*. Elsewhere it is तोरी *tori*, and so also in Champāran.
- (3) *Sesamum* (*sesamum orientale* or *Indicum*).—This is नील *til*. In South-West Shahabad तिळी *tilli* is a variety with a white grain, which is sown with the autumn crop.
- (4) *Linseed* (*linum usitatissimum*).—This is तीसी *tisi*. To the east it is also called चिकन्ना *chikna*.
- (5) *Safflower* (*carthamus tinctoria*).—See last chapter.
- (6) *Castor-oil plant* (*ricinus communis*).—This is रेंडू *renr* or लेंडू *lenr*, also अंरर *anrar* in the north-west, Tirhut, and South Bhagalpur, and अन्दा *anda* in Tirhut and South Bhagalpur. The seed is लेंडी *leñri* or रेंडी *reñri* generally, also अंररी *anrri* in the north-west, Tirhut, and South Bhagalpur, and अन्दी *andi* in Tirhut and South Bhagalpur. A plantation of this is रेंडुवारी *renrwāri* or लेंडुवारी *lenrwāri*.
- (7) *Bassia latifolia*.—The tree is called महु *mahu* or महुआ *mahua*. Its clusters of buds are छत्ता *chhatta* or कोंच *konch*. The flower which falls to the ground and is used for distilling spirits is महु *mahu* or महुआ. The oilnuts which are borne by the tree are कोइन *koin* north of the Ganges, or कोइनी *koini* in South-East Tirhut. In South-West Shahabad they are कोइन्दा *koinda*. In South Munger the *mahua*-pickers sing a song while employed, called टोहा *toha*.

- (8) *Celastrus paniculatus*.—This is मङ्कङ्गनी *malkangni* or डिठौरी *dithauri* in South-West Shahabad, मङ्कौनी *malkauni* in Patna and Gaya, मङ्कौनी *mankauni* in South-East Tirhut, कौनी *kauni* in South Munger.
- (9) *Croton (croton tiglium)*.—This is जमाल गौटा *jamāl gota* in Patna, Gaya, and the west.
- (10) Two other oils may be mentioned here. One is मिमियार के तेल *mimiyāi ke tel*, which is supposed to be extracted from the heads of coolie emigrants to the colonies, by hanging them head downwards over a slow fire, see §1464. The other is अकोल के तेल *akol ke tel*, made from the nut of the अकोल *akol (alcuritis triloba)* tree, which if rubbed on a person's body makes him invisible. This is like saying that if you catch a guinea pig by the tail his eyes will drop out; for the nut is so hard that it is impossible to extract oil from it.

CHAPTER XX.—FIBRES.

1046. *Hemp*, as a drug (*cannabis sativa*).—See Chapter XVI.

1047. *Hemp*, as a fibre plant.—There are two varieties of this :—

- (1) सन *san (crotolaria juncea)* or (North-East Tirhut) कस्मिरा *kasmira* or सोन *son*.
- (2) पटुआ *patua*, कुतुरम *kuturum*, or (in South Bhagalpur) कुदरम *kudrum (hibiscus cannabensis, Roxb.)* This is like *san*, except that its flower is like the safflower, and that it is used only for making the coarse fibre (चना *channa*). See below.

1048. The stalk is सनई *sanaī* north of the Ganges generally except in North-East Tirhut, where it is सनै *sanaī*. In Shahabad it is सनैठा *sanaitha*, in South Munger सनाठी *sanāthi*, and in South Bhagalpur सनसनाठी *sansanāthi*. When the bark has been removed, it is सन्ठी *santhi*, or in South Munger सनाठी *sanāthi*, and in South Bhagalpur सनसनाठी *sansanāthi*. A bundle of fibres is लरन्हा *larchha*, or in East Tirhut धोआ *dhoa* or थूआ *thūa*. Short stalks that remain in the fibre are called in North-East Tirhut गुदरी *gudri*, खुदर *khudar* to the west and in West Tirhut, कुदारी *kudāri* in North-East Tirhut,

and गुदर *gudar* in East Tirhut. In North-East Tirhut the coarsest fibres are called चन्ना *channa*, the next finest पटुआ *patua*, and the finest कसमिरा *kasmira*. There is no special name for the seed.

CHAPTER XXI.—BETEL.

1049. Betel (*piper betel*) is called पान *pān*, and the man who grows it बरई *barāi*. Amongst its varieties the best is कपूरी *kapūri*, which has a long leaf, mild, but slightly bitter. The next best is साँची *sānchi*. The common varieties are ककीर *kakīr* (North-East Tirhut) or ककेर *kaker* (South-East Tirhut), which has a large leaf and mild flavour; the बेलहरी *belahri* (south-west) or बेलहरी साँची *belahri sānchi* (North-East Tirhut), and the मगन्ही *maghi*, which have a round leaf and a sweet taste; and the बँगला *bangla* or (South-West Tirhut) बँगरा *bangra*, which is small and slightly bitter. To the west there is also a kind called करइचा *karāna*, which is small and sweet.

1050. The mound on which the plant is grown is भिण्डा *bhinda*, बरैठा *barāitha*, or पाढ़ *pārh* north of the Ganges. South of the Ganges it is भौड *bhūt*. A betel-garden is बरेव *barvo* or बरवे *barve*. The rows in the plantation are सपुरा *sapura* in Sāran and South Tirhut, and साँपुर *sāmpur* in North-East Tirhut. In South-West Shahabad they are पास *pās*, and in the rest of that district पाँती *pānti*. The intervening spaces are आँतर *āntar* or अँतर *antra*. They are also पाड़े *pāhe* in South-East Tirhut, दौंगर *daungar* in Patna and Gaya, and दौंग *dung* in the south-east. The main props down these lines are कोरो *koro* in Tirhut and कोरोई *korāi* in Shahabad. In the south-east and in Sāran they are इकरी *ikri*.

1051. The spaces between these props are in North-East Tirhut कोरोवास *korwās*. The supports of the plants are सरई *sarāi* north of the Ganges, or in South-East Tirhut खरही *kharhi*, of which there are generally six between each main prop. In Shahabad they are called ईंकर *īnkar*, and in the south-east सरकण्डा *sarkanda*. In Shahabad डँपी *dhempi* are the lumps of clay in which the plants are sown. The supports of the roof are also कोरो *kōro*, except in Patna and Gaya, where they are खम्भा *khambha*, and in South Munger, where they are खम्ही *khāmhi*. The walls are टुही *tutti*, or in East Tirhut टाट *tāt*, and in East Munger टाटी *tāti*. The roof is माड़ो *māro* or माँड़ो *mānro*. In South-East Tirhut it is optionally माड़व *mārab*. In South-West Tirhut

it is ठटरा *thatra*, and in Shahabad and East Tirhut optionally खानी *khāni*. In South Munger it is मङ्गवा *marwa* or ठटरौ *thatrī*.

1052. The brushwood on the top is खरदे *kharaḍi* or (in South-West Shahabad) खरचा *kharcha*, and in South Munger कचुषा *kachua*. The young seedlings for planting are कलम *kalam* in Patna, Gaya, and Shahabad, and बेल *bel* elsewhere. They are watered from an earthen vessel called लोटी *loti* or (in Sāran) लोट *lot*. In North-East Tirhut मटोर *mator* is a basket in which the gardener carries earth to the plant, and which he also uses for keeping the leaves. In East Tirhut भूर *bhūr*, and in South Tirhut भूरा *bhūra*, are the shoots which come out of the plant near the root in Jeth (May-June), and कन *kan* are those which come out in Bhādon (August-September).

1053. A packet of twenty leaves is called a कोरी *kori* south of the Ganges. North of the Ganges one of fifty leaves is called चौठैया *chauthaiya*, and one of a hundred leaves चाधा ढोली *āḍha dholi*. A ढोली *dholi* has 200 leaves.

1054. North of the Ganges and in Shahabad—

7 ढोली <i>dholi</i>	=	1 कनवाँ <i>kanvān</i> .
14 ditto	=	1 अधवा <i>adhwa</i> .
28 ditto	=	1 पौषा <i>paua</i> or पावा <i>pāwa</i> .
4 पौषा <i>paua</i>	=	1 लेशो <i>leso</i> .

1055. Elsewhere south of the Ganges 108 ढोली *dholi* make 1 लेशो *leso*. A leaf of betel rolled up in a cone for chewing is बीड़ा *bīra*, बिरवा *bīrwa*, or बिरिया *biriya* or खिल्ली *khilli*. It is also गिलौरी *gilauri*. सिंघारा *siṅghāra* are the triangular-shaped packets. Betel is kept for consumption in a wickerwork basket, called बेलहरा *betahra* or (in East Tirhut) बिरहरा *bīrahra*. In North-East Tirhut ढाकी *dhāki* is a large basket used by the betel-grower for the same purpose.

1056. The betel-nut, which is the fruit of the *areca catechu*, is called सुपारी *supāri* or सोपारी *sopāri*. Other names are कसैली *kasaili* north of the Ganges, and मुखसुध *mukhsudh*, मुखसुधि or मुखसुधी *mukhsudhi*, in East Tirhut. The nippers for cutting the nut are सरौता *sarouta*. A well-known proverb is मुखसुधि न० परकार, तनिका अड़ियातक बड़ चमकार *mukhsudhi na parkār, tanika ariyātak bar chamatkār*,—he can't afford to give his guest even a bit of betel-nut, and yet he escorts him out of the house with as great pomp as if he had been actually entertaining him.

CHAPTER XXII.—GARDEN CROPS.

1057. These may be divided into—(1) edible roots, (2) gourds, (3) miscellaneous.

EDIBLE ROOTS.

- (1) *Potatoes (solanum tuberosum or esculentum)*.—आलू *ālu*, and in East Tirhut also आरू *āru*. Also north of the Ganges अलुआ *alua* and अलुई *alūi*. North of the Ganges ललन्का *lalka* or दक्षिणी *dackhini* is a red kind, and मलन्दहिया *maldahiya* or नपाली *napāli* a white one. A red variety of the last name but one is called मलन्दहिया कनकपुरिया *maldahiya kanakpuriya*. Seed potatoes brought from the hills are बीया के आलू *biya ke alu*, and each eye is आँखि *ānkhī* or आँख *ānkh*. The produce of these kept for next year is called पहिला माँटी के बीया *pahila māṅṅī ke biya*, and the produce again of this kept for seed for the third year is दोसरा माँटी के बीया *dosra māṅṅī ke biya*.
1058. (2) *Yams (dioscorea sativa)*.—These are लतार *latār* generally north of the Ganges, and also रतार *ratār* to the west. To the north-west yet another name is अतार *atār*, and to the south-west कठार *kathār*. In Patna and Gaya it is रतारू *ratālu*. In Tirhut it is also called फार *phar*, and to the east also खम्हरा *khamharua*.
1059. (3) *Sweet potato (batatas edulis)*.—This is सकरकन्द *sakar-kand* generally. North of the Ganges it is also called लमन्का अलुआ *lumka alua*, and in South-East Tirhut अलुआ *alhua*. In East Bihār it is अलुआ *alua*. North of the Ganges there are two varieties :—(a) A red one, called देसी *desi*, and also in South Tirhut ललन्का *lalka*; (b) a white one, called बिलाएती *bilāēti*, and also करन्मिया *karmiya*, and in South Tirhut also उजरन्का *ujarka*. A large white variety, weighing from one to twenty sers, is called in North-East Tirhut तेकुना *tekuna*.
1060. (4) A kind of yam (*dioscorea fasciculata*).—सुधन्नी *suthni*.
1061. (5) *Arum colocasia*.—This is अरुई *arui* generally. Also अरबी *arabbi* in North-East Tirhut, पेकन्चा *pekcha* in South-East Tirhut, पेकन्ची *pekchi* in Shahabad, पेपन्ची *pepchi* in Gaya and Shahabad, and in South Bhagalpur

बलनी *alli*. Another variety (*colocasia antiquorum*) is कच्चा *kachchu*. A larger variety is अरुआ *arua* or कन्दा *kanda*.

1062. (6) राम केशौर *rām kesaur* (North Tirhut), or मिसिरी कन *misiri kan* (East Tirhut), a large edible root sometimes weighing eight or nine *seers*. Considered a very cooling food.
1063. (7) आदीचक *ādīchak*, the Jerusalem artichoke (*Helianthus tuberosus*).

GOURDS.

1064. (1) *The water-melon* (*cucurbit citrullus* or *citrullus vulgaris*).—These are तरबूज *tarbūj* or तरबूजा *tarbūja* or in North-East Tirhut तारभूज *tārbhūj*. In Champāran they are also called पनीहौआ *panihaua*, and in South-West Shahabad हिनुआना *hinuāna*.
1065. (2) *The melon* (*cucumis utilatissimus* or *cucumis melo*).—खरबूजा *kharbūja*. Also लालमौ *lālmī* in West Tirhut and Patna and the west, and फूंट *phūnt* (which is properly the *cucumis momordica*) to the south-east.
1066. (3) *Cucumis momordica*.—This is फूंट *phūnt* when it is ripe after bursting spontaneously. The young fruit used for cooking is डाम *dām* and (South-West Shahabad) डभन्को *dabhko*.
1067. (4) *The bitter gourd* (*momordica charantia*).—करैला *karaila*, also करैली *karaili* in Shahabad and South Bhalgalpur and करैल *karail* in North-East Tirhut.
1068. (5) *The bottle-gourd* (*lagenaria vulgaris* or *cucurbita lagenaria*).—This is कटुआ *kadua* generally, or कद्दू *kaddu* in South Bhalgalpur. Another name in Gaya, South Munger, and the west generally is लौका *lauka*, with a variant लौआ *laua* in Patna. In East Tirhut it is also called सज्जिवन *sajjivan*.
1069. (6) *Lagenaria acutangulus* or *cucumis acutangulus*.—This is तरौद *taroi* generally. Other varieties are सतपुतिआ *satputiya*, जिङ्गा *jhinga*, जिङ्गुनी *jhinguni*, or जिङ्गुली *jhinguli*, and नैनुआँ *nenuan*, घिउरा *ghiura*, or घेनुआ *gheura*.
1070. (7) *Cucumber* (*cucumis sativus*).—खीरा *khīra*. A variety is बालम खीरा *bālam khīra* in Shahabad. A large variety of

cucumber is called ककड़ी *kakri* or काँकरि *kānkari* (*cucumis utilatissimus*). Natives much appreciate this vegetable, as in the proverb निकौरिया गेलाँह हाट, काँकरि देखि हिया फाट *nikauriya gelāh hāt, kānkari dekhi hiya phāt*,—the man without money went to market, and his heart burst when he saw the cucumber. The great size of the plant is well illustrated by the proverb एक हाथक काँकरि, नौ हाथक बीया *ek hāthak kānkari, nau hāthak biya*,—a cucumber only one cubit long has an offspring nine cubits long. (Cf. the parable of the grain of mustard-seed.)

1071. (8) The sweet pumpkin (*cucurbita pepo*).—This is कौँहड़ा *koñhra*; also in North Tirhut कोन्हड़ा *komhra*, and in East Tirhut कदीमा *kadīma*. Another variety, much used for making sweetmeats, is भतुआ *bhatua* to the west; also भूआ *bhūa* or भूरा *bhūra* in Gaya, सिसकौँहड़ा *siskoñhra* in Champāran, सिजकौँहड़ा *sijkoñhra* in Tirhut, सुरजकौँहड़ा *surajkoñhra* in South-East Tirhut, and कुन्हड़ *kumhar* to the east.
1072. (9) चिचिरा *chichira* or चिचुरा *chichura* (north of the Ganges), the snake-gourd (*trichosanthes anguina*).—In East Tirhut it is कैना *kaita*, and in Sāran कैन *kait*.

MISCELLANEOUS VEGETABLES (IN ALPHABETICAL ORDER).

1073. The writer regrets that he has not been able to identify the botanical names of more than a few of the under-mentioned plants. In some cases the identification given is doubtful. He has to thank Dr. Shaw, Civil Surgeon of Darbhanga, for much assistance rendered in correcting the botanical portion of this division.

अजमोदा *ajmoda* or (Tirhut) बनजेवाइन *banjewaïn*, parsley (*petroselinum sativum* or ? *apium involucratum*).—Cf. पितरसेली *pitarseli*.

अजवाइन *ajwaïn*,—see जवाइन *javāïn*.

अदरक *adrakh* or अदरक *adrak*, ginger (*zingiber officinale*), also आदी *ādi* generally, आद *ād* in South-East Tirhut.

असफगोल *asaphgol*,—see सफगोल *saphgol*.

आद *ād*, आदी *ādi*,—see अदरक *adrakh*.

इमिरन्ती *imirti*, or in Gaya रमन्चरन्ना *rancharna*, an acid curry-vegetable, the fruit of *spondia mangifera* (?).

कथ *kath*,—see खैर *khair*.

कमल पत्र *kamal patr*,—see पिघाज *piḡāj*.

करमन्कजा *karamkalla* or बन्धा कोबी *bandha kobi*, cabbage (*brassica oleracea*).

कलन्मी साग *kalmi sāg*, the tops of *convolvulus repens*, much used as a spinach.

कवाह *kawāchh*,—see केवाँह *kewāchh*.

कासन्नी *kāsni*, endive (*cichorium endivia*).

काह *kāhu* (Patna and Gaya), a kind of lettuce (*lactuca sativa*).

कुन्री *kunri*, a creeping-plant, of which the fruit is used for curries.

केवाँह *kewāchh* or कवाह *kawāchh*, a plant which produces a pod like a bean (*dolichos pruriens*). In Gaya it is रूप सेम *bhūp sem*.

कैता *kaita*,—see चिचिरा *chichira*.

कोचन्ला के साग *kochla ke sāg*, a kind of spinach.

कोबी *kobi*, the cabbage (*brassica oleracea*).

खुरन्फा *khurpha* or गोलावा *golāwa* (Saran, Patna, and Gaya), purslane (*portulaca sativa*).

खुसन्बरी *khusbari*,—see मकोय *makoe*.

खेखन्सा *kheksa*,—see चठैल *chathail*.

खैर *khair* or कथ *kath*, catechu (*acacia catechu*).

गदीना *gadina*, a kind of pot-herb with a taste of garlic.

गजन्रा or गजन्डा *gajra* or (in South-West Shahabad) गाजड़ *gājar*, the carrot (*daucus carota*).

गाजड़ *gājar*,—see गजन्रा *gajra*.

गुलन्फा *gulpha*, a kind of spinach.

गेन्हरी *genhri* or (in East Tirhut) गेन्हारी *genhāri*, a pot-herb (? *amaranthus frumentaceus*).

गलन्हय्ता *gelhanta*, गोलन्भय्ता *golbhanta*,—see बैंगन *baingan*.

गोलावा *golāwa*,—see खुरन्फा *khurpha*.

गोल मिरिच *gol mirich* or गुलमिरिच *gulmirich*,—see मिरिच *mirich*.

घँच *ghench* (North-East Tirhut), an aquatic tuber whose white stalk is eaten by the poor (? *aponogeton monostachyon*).

चटैल *chathail* or चटैल *chatail*, a much-appreciated curry-vegetable, a creeping-plant. In Gaya it is called खेखसा *khekhṣa*.

चनन्दुर *chansur*, a kind of cress (*lepidum sativum*).

चितरन्सेली *chitarseli*,—see पितरन्सेली *pitarseli*.

चंगवा *chengwa*,—see बैंगन *baingan*.

जवाइन *javāin* (west, Patna, and South Bhagalpur), अजवाइन *ajvāin* (Gaya and South Munger), जेवाइन *jevāin* (north of the Ganges), a plant something like aniseed (*ligusticum ajowan* and *ptychotis ajowan*), खोरासानी जवाइन *khōrasāni javāin* is *hyosciamus niger*. This plant is not the true aniseed (*anisi*).

जीरा *jira* or (South-East Tirhut) जीर *jir*, cummin (*cuminum cyminum*).

जेवाइन *jevāin*,—see अजवाइन *ajvāin*

उड़िया *tharhiya*,—see मारन्सा *mārsa*.

डिड़िया मिरन्चार *diriya mirchāi*, डैरिया मिरन्चार *dheñriya mirchāi*,—see मिरिच *mirich*.

तरन्कारी *tarkāri*,—see तीयन *tiyan*.

तरन्कोंका *tarkonka* (Patna), the bud of the red lotus, used for medicine.

तीयन *tiyan*, तरन्कारी *tarkāri*, or पतौरा *pataura*, the general term for vegetables.

धनियाँ *dhanīyān*, coriander (*coriandrum sativum*).

नेवार *newār*,—see मुली *mūli*.

पतौरा *pataura*,—see तीयन *tiyan*.

परन्वर *parwar*, पलन्वल *palwal*, परोर *paror*, परोरा *parora*, or (in South Bhagalpur) परोल *parol* (*trichosanthes dioica*), (Roxb.)

पलँकी *palānki*,—see पालक *pālak*.

पालक *pālak*, पालँकी *pālki* or (East Tirhut and Champaran) पलँकी *pāiānki*, spinach (*spinacea oleracea*).

पितरन्सेली *pitarseli* or (Tirhut) चितरन्सेली *chitarseli*, parsley (*petroselinum sativum* or ? *apium involucratum*).—Cf. अजमोदा *ajmoda*.

पियाज *piyāj* or (South Bhagalpur) पेयाज *peyāj*, and north-west कमल पतर *kamal patr*, the onion (*allium cepa*).

पुदेना *pudena*,—see पोदीना *podina*.

पोदीना *podina*, पोदेना *podena*, or पुदेना *pudena*, also (Tirhut) झदेना *phudena*, mint (*mentha sativa* or *viridis*).

झदेना *phudena*,—see पोदीना *podina*.

फुलकूबी *phulkobi*, the cauliflower (*brassica oleracea*).

बकन्ला *bakla*, बकुली *bakuli*, बँगन्ला *bangla*,—see बोकन्ला *bokla*.

बनज्जेवारन *banjewān*,—see अजमोदा *ajmoda*.

बनसुटन्का *banbhutka*,—see मकोय *makoe*.

बिरन्वार *birwāi* (Gaya), vegetable seedlings.

बिलाग्रती पदुआ *bilāēti patua*, roselle (*hibiscus sabdariffa*).

बिलाग्रती बैंगन *bilāēti baingan*, the tomato (*solanum lycopersicum*).

बैंगन *baingan*, भयटा *bhanta* (usually confined to the round variety) or गोलभयटा *golbhanta*, and in South Munger also गेलन्हयटा *gelhanta* and चँगवा बैंगन *chengwa baingan*. In East Tirhut it is optionally भाँटा *bhānta*; the egg-plant (*solanum melongena*). Compare the proverb काहू के भयटा बैरी काहू के भयटा पन्थ *kāhu ke bhanta bairi, kāhu ke bhanta panth*,—to some the egg-plant is an enemy, to others it is prescribed as a regimen; *i.e.*, what is one man's meat is another's poison.

बोकन्ला *bokla* or बँगन्ला *bangla* (north-west), बकन्ला *bakla* (Cham-pāran), बकुली *bakuli* (South-West Tirhut), बोकन्ला बीन *bokla bīn* (South-East Tirhut) (?), a kind of bean (? *faba major*).

भटकूचाँ *bhatkūān*, भटकूचाँ *bhatkoñā*,—see मकोय *makoe*.

भयटा *bhanta*,—see बैंगन *baingan*.

भिण्डी *bhindi* or राम तरौ *rām taroi*, also to the east राम परोर *rām paror*, a long kind of fruit used for cooking (*hibiscus esculentus* or *abelmoschus esculentus*).

सुटन्का *bhutka*,—see मकोय *makoe*.

बूप सेम *bhūp sem*,—see केवाँह *kewānchh*.

मकोय *makoe* (west and Tirhut), खुसन्बरी *khusbari* (gooseberry), or (purple variety) भटकूचाँ *bhatkoñā* or भटकूचाँ *bhat kūān*, the cape gooseberry, or *tiparee* (*physalis Peruviana*). The red variety is also सुटन्का *bhutka* or बनसुटन्का *ban bhutka* in South-East Tirhut.

मरिचा *maricha*,—see मिरिच *mirich*.

मारंग्सा *mārsa* or ठडिया *tharhiya* (west), *amaranthus mangostanus*.

मिरन्चा *mircha*, मिरन्चाइ *mirchāi*,—see मिरिच *mirich*.

मिरिच *mirich* or (West Tirhut, Shahabad, and Gaya) मरिचा *maricha* and मिरन्चाइ *mirchāi*, (Patna) मिरन्चा *mircha*, (South Munger) डिडिया मिरन्चाइ *diriya mirchāi*, (Gaya) डेरिया मिरन्चाइ *dheñriya mirchāi*, long pepper, &c. (*capsicum fastigiatum*, &c.) गोळ मिरिच *gol mirich* or गुलमिरिच *gul mirich* is black pepper (*piper nigrum*). Bird's eye pepper (*capsicum baccatum*) is लोंगिया मरिचा *longiya maricha* or जैया मिरन्चा *jaiya mircha*.

मुनगा *munga*,—see सैयन *saiyan*.

मुरई *murāi*, मुराइ *murāi*, मुळी *mulli*, मूर *mūr*, मूरो *mūro*,—see मूली *mūli*.

मूली *mūli*, मुळी *mulli*, or मुरई *murāi* or (East Tirhut optionally) मूर *mūr*, (South Munger) मुराइ *murāi*, (South Bhagalpur) मूरो *mūro*, the radish (*raphanus sativus*). In Shahabad there are two kinds—(1) नेवार *newār*, which is large, and (2) लुतिया *lutiya* or देसिला *desila*, which is small.

मेथी *methi* or मँथी *menthi*, fenugreek (*trigonella fenum Græcum*).

रमन्चरना *ramcharna*,—see इमिरन्ती *imirti*.

रखन *rasūn*, रसुन *rassun*,—see लहसुन *lahsun*.

रहरिया सेम *rahariya sem* or राम रहर *rām rahar*, a kind of bean, not a climbing-plant, but a shrub.

राम तरौद *rām taroi*, राम परोर *rām paror*,—see भिन्डी *bhindi*.

लहसुन *lahsun*, or to the east रखन *rasūn* or रसुन *rassun*, garlic (*allium sativum*). A clove of garlic is पोटौ *poti* or पोट *pot*.

लुतिया *lutiya*,—see मूली *mūli*.

लोंगिया मिरिच *longiya mirich*,—see मिरिच *mirich*.

सफगोल *saphgol*, or in South-West Shahabad असफगोल *asaphyol* (*phantayo isabghola*).

सलजम *saljam* and also (south of the Ganges) सलजम *saljam*, the turnip (*brassica rapa*).

सहजन *sahjan*, &c.,—see सैयन *saiyan*.

सिंघाड़ा *singhāra*, the water-caltrop (*trapa bispinosa* or *nutans*).

सीम *sim*,—see सेम *sem*.

सेम *sem* (west), सीम *sim* (east), a bean (*phaseolus magnus*). A variety is सेमा *sema*.

सेयन *saiyan*, or (Tirhut) सोहिजन *sohijan* or सोहजन *sohjan* or सहजन *sahjan*, or (Shahabad) सँहिजन *sañhijan* or (Patna) सहजना *sahjana*, the horse-radish tree (*hyperanthera moringa*). Its fruit is called मुनगा *munga*, and is used as a vegetable, and its root (which tastes like horse-radish) is used as a condiment.

सौंफ *saumph*, ? a kind of aniseed (*peucedanum graveolens* or *anethum soua*).

हरन्दी *hardi*, or in Shahabad optionally हलन्दी *halldi*, turmeric (*curcuma longa*).

हलन्दी *halldi*,—see हरन्दी *hardi*.

SUBDIVISION II.

INSECTS AND CAUSES OF INJURY TO CROPS.

CHAPTER I.—DESTRUCTIVE INSECTS AND DISEASES.

1074. Among these may be noted the following, which are arranged in alphabetical order:—

अँगरा *angra* (north-west), भरन्का *jharka* (Sāran and Tirhut), blight in cereals caused by the sharp west wind; also (Champāran) a blight in opium. See मुरन्का *murka*.

अरैया *araiya*,—see पोषारी *poāri*.

उकन्ठा *uktha* (south), a sort of mildew which dries up the grain in wheat.

उकन्हा *ukrha*, उखन्रा *ukhra*, उकन्सा *uksa*,—see उखन्ठा *ukhtha*.

उखन्ठा *ukhtha* or उकन्हा *ukrha* (north generally), उखन्रा *ukhra* (Tirhut), उकन्सा *uksa* (north-west), withering of crops from excessive drought.

औरङ्ग *aurang* (Champāran),—see गपन्तू *gaptu*; also (north-west) or (in Tirhut) बभन्नी *babhni*, a white spot appearing in the

leaf of millets, causing them to wither up.

कचोहा *kachoha* (South Bhagalpur), a disease in tobacco.

कजन्ना *kajra*,—see कजन्नी *kajri*.

कजन्नी *kajri* (generally), कजन्ना *kajra* (West Tirhut, Patna, and Gaya), कजन्ना *kajla* (North-West Tirhut), मजन्नी *majri* (East Tirhut), a green grub which eats the young plants of rice, wheat, and barley when they are about six inches high.

कजन्ना *kajla*,—see कजन्नी *kajri*.

कट्टर *katui*, an aquatic beetle which infests rice.

कटैया *kataiya* (South-West Shahabad), कटोई *katoī*, कटोइया *katoīya* (elsewhere south of the Ganges), a blight which attacks rice and turns the ears an orange colour and destroys them.

कटोइया *katoīya*, कटोई *katoī*,—see कटैया *kataiya*.

कतन्नी *katni* (South-West Shahabad), a disease of the rice-plant.

कनाठा *kanātha*, कन्ही *kanhi*,—see खीरी *chhīri*.

कपट्टा *kapta* (Champāran), an insect which attacks young rice.

कसुआ *kamua*,—see कम्मा *kamma*.

कम्मा *kamma* or कसुआ *kamua* (Patna), a smooth kind of caterpillar.

किरौना *kirauna*,—see गाँधी *gāndhi*.

कीरी *kīri* or (South Bhagalpur) कीरो *kīro*, a maggot.

कुकुडी *kukurhi* (Sāran and Tirhut), an insect which attacks cotton.

कुकुही *kukuhī* (north-west), an insect which injures the cold-weather crops.

कुसन्वटना *kuswatna* (north-west), कुसियाना *kusiyāna* (Tirhut), a blight in transplanted rice.

कुसियाना *kusiyāna*,—see कुसन्वटना *kuswatna*.

कौआँ *keūān*,—see लरका *larka*.

कोइया *koīya*, a tiny black insect which does great damage in granaries.

कोइली *koīli*, कोइया *korhiya*, कैलिया *kailiya*, blights of various kinds in rice.

कोइया *korhiya*, कैलिया *kailiya*,—see कोइली *koīli*.

खँखन्ही *khankhri*, a blight in cereals on account of which no

खपण्डोदया *khapṛōiya* (Champāran), गङ्गरा *garra* (Gaya, Sāran, and Tirhut), a small white insect which attacks rice.

खरुका *kharuka*,—see जाला *jāla*.

खैरा *khaira* (west), खैरी *khairi* (North-East Tirhut), a blight which attacks rice and turns the ears an orange colour and destroys them.

गङ्गरा *garra*,—see खपण्डोदया *khapṛōiya*.

गड़ार *garār* (north), a grub which attacks the roots of sugar-cane.

गदहो *gadhi* (north) or (Sāran and East Tirhut) गदहिया *gadahiya*, an insect very destructive to growing pulses.

गन्धकी *gandhki* (Patna and Sāran), a small green fly, which attacks rice.

गन्धी *gandhi*,—see गाँधी *gāndhi*.

गपन्तू *gaptu* or गपन्तुआ *gaptua* (Patna and north), गभन्तू *gabhtu*, ठौंठियारी *thonthiyāri* (Shahabad), गपन्ख *gapsu* (Sāran), and औरङ्ग *aurang* (Champāran), a disease affecting millets, sugar-cane, and Indian corn, in which the tops wither.

गभन्तू *gabhtu*,—see गपन्तू *gaptu*.

गादुर *gādur* (South-West Shahabad), an insect which attacks pease and gram.

गाँधी *gāndhi* or गन्धी *gandhi*, also to the west गंधवा *gandhwa*. Other names are माँची *mānchhi* (north generally), किरौना *kirauna* (South-West Shahabad), and भेमरा *bhemra* (South Munger), the flying-bug,—an evil-smelling insect, which attacks principally the millets before the flowers are formed.

गेरुआ *gerua* (west), the grub which attacks the roots of sugar-cane.

गेरुई *geruī* (north and south-west), a disease of the cereal crops, in which the plant dries up and assumes a reddish colour while the ear is black. It is caused by excess of winter rains and east wind.

गोबन्तौरा *gobraura* (West Tirhut and west), blight in betel.

- गोभी *gobhi*, a disease produced by prevalence of severe winds, and consisting in the plant giving out little shoots, which weaken it.
- गौंजी *gaunchhi* (West Tirhut, Patna, and Gaya), an aquatic beetle which destroys rice by floating from one plant to another in a boat made of a leaf.
- घँघरी *ghanghri* (Shahabad),—see घोंघड़ी *ghonghri*.
- घून *ghūn*, a weevil destructive to wood and grain.
- घोंघड़ी *ghonghri* or (Shahabad) घँघरी *ghanghri*, a worm in the ear of millets and gram.
- घतग्रा *chatra*,—see सुचार *muār*.
- चपटन्वा *chapatwa* (South-West Shahabad), a small green fly which attacks rice.
- छपट्टा *chhaptu* (north-west), पचकट्टा *pachkatta* or (Tirhut) पतकट्टा *patkatta*, a green caterpillar which eats up the rice-plant.
- छीरा *chhira*,—see छीरी *chhīri*.
- छीरी *chhīri* (south and west), छेंड़ी *chhenri* north-west and Tirhut), also छीरा *chhira* in Champāran. Other names are कन्ही *kanhi* (South Munger) and कनाठा *kanātha* (South Bhagalpur), the palmer (?) worm, which attacks pulses, cotton, and tobacco.
- छेंड़ी *chhenri*,—see छीरी *chhīri*.
- जाला *jāla* (Tirhut, Patna, and east), पक्खन *pakkhan* (West Tirhut and Gaya), खरुका *kharuka* (South-West Shahabad), सुरन्का *murka* (west and West Tirhut), a blight in opium.
- ज्जरन्का *jharka*,—see अँगरा *angra*.
- जिह्ली *jhilli* (north-west), फुलन्मङ्गा *phulbhanga* (Tirhut), an insect which eats the stalks of pulses and makes the leaves crumple up.
- टाड़ा *tāra* or टाँड़ा *tāra* (west), a small green insect which ravages wheat and eats the roots of sugar-cane.
- टाड़ा *tāra* (north-west), टाँड़ी *tāri* (North-West Tirhut), a grub which eats the young plants of wheat and barley when they are about six inches high.
- टीड़ी *tīri* or (South-West Shahabad) टिरन्री *tirri*, and फरिङ्गा *pharinga* (Tirhut and east), the locust.

हुमकी *tunki* (north), a disease which attacks rice.

थोंठियारी *thonthiyāri*,—see गपन् *gaptu*.

नितिली *titili*, a butterfly.

तेलचट *telchat* (Patna and east), पटोर *patoī* (West Tirhut, Gaya, and South Munger), a disease of the castor-oil plant.

दखिनचा *dakhincha*, (north and south-west), also दखिनाचा *dakhinācha* (Gaya and south-west); also नीमा *nīma* (North Tirhut), सिरोरा *sirora* (Patna), and पीरो *piro* (South Bhagalpur), a disease of rice, millets, and sugar-cane caused by a noxious wind from the south. A white spot appears on the leaf of millets, and they wither. In sugar-cane the tops wither.

दहिया *dahiya* (north), a disease in चीना *chīna* (*Panicum frumentosum*).

दिअंका *dianka*, दिअंका *diunka*, दियँडा *diyānra*, दियार *diyār*, दिवार *divār*,—see दीयँ *diyān*.

दीयँ *diyān* or दियँडा *diyānra* (Patna, Gaya, and south-east), दिअंका *diunka* (South-West Shahabad), दिअंका *dianka* or दिअका *diuka* (west generally), दियार *diyār* (Champāran and Tirhut), and दिवार *divār* (East Tirhut), the white ant.

नीमा *nīma*,—see दखिनचा *dakhincha*.

नेहा *nerha*,—see लेंहा *lenhra*.

पक्खन *pakkhan*,—see जाला *jāla*.

पक्खी *pakki* or पखिया *pakhiya*, a small insect which attacks the *singhāra* plant or water-caltrop (*trapa natans* or *bispinosa*).

पचकडा *pachkatta*, पतकडा *patkatta*,—see छपटा *chhapta*.

पटाही *patārhi*,—see पेटाही *petārhi*.

पटोर *patoī*,—see तेलचट *telchat*.

पिटोर *pitoi* (Patna and South Munger), a small green insect, which ravages wheat and eats the roots of sugar-cane. = टँडा *tānra*, *q.v.*

पिलू *pillu* or पिलुचा *pilua*, a small white maggot, which attacks cotton, safflower, and grain, whether growing or stored.

पिहिका *pihika*,—see सुखगड़ा *sukhra*.

पीरो *pīro*,—see दखिनगहा *dakhinha*.

पेटाही *petārhi* or पटाही *patārhi* (Tirhut), an insect which attacks stored rice only.

पेटारन्ही *petārhi* (Shahabad), a red-coloured insect which attacks cotton, gram, and the castor-oil plant.

पैया *paiya*, a worm in the ear of grain.

पोषारी *poāri* (east) or अरैया *araiya* (South Munger), a disease of the rice-plant.

पौंजी *paunchhi* (Patna and South Munger), a branch springing from the root of sugar-cane and injuring it.

फटगहा *phatha* (South Bhagalpur), फहा *phatta* (South Munger), a disease of the rice-plant.

फहा *phatta*,—see फटगहा *phatha*.

फतिङ्गी *phatingi*, a kind of grasshopper which eats the leaves of sugar-cane.

फनगी *phangi* (west), a kind of grasshopper which appears in years of drought and attacks roots of wheat and gram.

फनिगा *phaniga*,—see सुरका *surka*.

फरिङ्गा *pharinga*,—see टीही *tīri*.

फाटी *phāti*, a blight in the ear of rice.

फाँड़ा *phānra* (Tirhut) or फाँड़ी *phānri* (Tirhut), a weevil destructive of wood and grain.

फुलन्मङ्गा *phullhanga*,—see भिखी *jhilli*.

बकुला *bakula*,—see बखी *bakki*.

बकुली *bakuli* (south-west), a green caterpillar destructive to rice.
Cf. काजरी *kajri*.

बकेया *bakeya*,—see बखी *bakki*.

बखी *bakki*, also बकेया *bakeya* or बकुला *bakula* (also in West Tirhut) in Shahabad, and बुदिया *burhiya* or बड़न्ही *barhi* in South Bhagalpur, a small kind of caterpillar which attacks rice. A larger kind is बाँका *bānka*.

बड़न्ही *barhi*,—see बखी *bakki*.

बभन्नी *babhni* (Tirhut), a blight affecting rice, sugar-cane, millets, and opium. See also औरङ्ग *aurang* and सुरका *murka*.

बलुआ *balua*, बलुई *balui*,—see बालू *bālu*.

बाँका *bānka*,—see बक्की *bakki*.

बाँकी *bānki* (Gaya), a disease which attacks the leaves of trees (especially the pepper-tree), and causes them to curl up and wither.

बाला *bāla*,—see बालू *bālu*.

बालू *bālu* or बलुआ *balua* (Patna, Gaya, and south-east), बलुई *balui* (Shahabad), बाला *bāla* (South-West Shahabad), an insect which eats the stalks of pulses and makes the leaves crumple up.

बीभल *bijhal* (Gaya and South Munger), weevil-eaten.

बुढ़िया *burhiya*,—see बक्की *bakki*.

भङ्ग *bhankh*,—see भँख *bhānkh*.

भरन्का *bharka* (West Tirhut and south-east), an insect injurious to rice, caused by prevalence of south winds and excess of rain.

भँवरा *bhānura*,—see भँड़ा *bhenra*.

भरन्की *bharki* (South Bhagalpur), a disease of the rice-plant.

भँख *bhānkh* (north) and also भँखी *bhānkhī* (north), भङ्ग *bhankh* (east), a blight which attacks the millet साँवाँ *sāwān* (*panicum frumentaceum*).

सदला *bhuila*, सदली *bhuili*, सुररी *bhurri*, सुरली *bhurli*, सरिला *bhurila*, सरिली *bhurili*,—see भूआ *bhūa*.

भूआ *bhūa* (Tirhut, Patna, Gaya, and east), सदला *bhuila* or सदली *bhuili* (West Tirhut and north-west), also सुरली *bhurli* (Saran), सरिला *bhurila*, सरिली *bhurili*, or सुरन्डी *bhurri* (south-west), a hairy worm which eats the leaves of the castor-oil plant and pulses, and is fatal to cattle when eaten.

भँड़ा *bhenra* or भँड़वा *bhenwa* (Patna and east), भँवरा *bhānura* (West Tirhut and Shahabad), an insect which attacks millets and stored grain in dry weather.

भेमरा *bhemra*,—see गाँधी *gāndhī*.

मगरा *mangra* (South-West Shahabad), an insect which attacks the sugar-cane in the root.

मजरी *majri*,—see कजरी *kajri*.

मरहिनना *marhinna*, मरी *mari*,—see मुषार *muār*.

माँची *mānchhi*,—see गाँधी *gāndhi*.

मारा *māra* (North-East Tirhut), a disease in rice which withers the plants.

मुषार *muār* (west), चतरा *chatra* (Patna and Gaya), मरहिनना *marhinna* (Tirhut and East), मरी *mari* (West Tirhut and South Bhagalpur), a disease in which the whole plant is burnt up.

मुरका *murka* (north), also अँगरा *angra* (Champaran), and बभनी *babhi* (Tirhut), a blight in opium. See जाला *jāla*.

मुरिया *muriya*,—see सुखड़ा *sukhra*.

लहमिनिया *luchhminiya* (East Tirhut), a small, thin, red-coloured beetle found in granaries. It does no harm, and is revered by grain-merchants.

लरका *laraka* or (Gaya) लुरका *lurka*, a worm which attacks gram and pease. North of the Ganges it also burrows into the ribs of the leaf of the tobacco-plant, and is then called केँउचाँ *keñuān* in Tirhut.

लाची *lāhi*, plant-lice.

लँदा *lenrha* (west and West Tirhut), नेदा *nerha* (Tirhut), a disease in wheat or barley in which the ears turn black.

सड़का *sarka*, a worm in the root of rice.

सिक्का *siruka*,—see सुरका *surka*.

सिरोरा *sirora*,—see दखिनहा *dakhinha*.

सुखठा *sukhtha*,—see सुखड़ा *sukhra*.

सुखड़ा *sukhra* (West Tirhut and south generally), सुखठा *sukhtha* (West Tirhut and west), पिहिका *pihika* (rest of Shahabad), मुरिया *muriya* (South Bhagalpur), a blight in sugar-cane.

सुंदरी *sundri* (east), an insect which eats the leaves of the castor-oil plant.

सुप्पा *sunda*,—see सूँड़ा *sūnra*.

सुरका *surka* (East Tirhut and Shahabad), सिक्का *siruka* (Saran and Patna), फनिगा *phaniga* (Tirhut and South-West Shahabad), an insect which eats the leaves of sugar-cane and destroys gram, pease, and cereals.

सूँडा *sūnra* or सूँड़ी *sūnri* (Tirhut and south generally), सूँद *sūnrh* or सूँदा *sūnrha* (Gaya), सुण्डा *sunda* (West Tirhut and south-east), a kind of weevil destructive to wood and stored grain. Cf. कीरी *kīri*.

सूँद *sūnrh*,—see सूँडा *sūnra*.

हड्डा *hadda* a white stem growing out of the root of the tobacco-plant, and throwing it far out of the soil.

हथिया *hathiya* (North-East Tirhut and Gaya) and हथिया सुण्डा *hathiya sunda* (south-east), a small white insect which damages rice.

हरन्दा *harda* (north and east), a sort of mildew which dries up the grain in cereal crops. The plant turns yellow, and the ear black.

CHAPTER II.—NOXIOUS WEEDS.

1075. These are as follows:—

अँकन्टा *ankta*,—see अँकन्रा *ankra*.

अँकन्रा *ankra* or अँकन्री *ankri* (West Tirhut and Shahabad), अँकन्टा *ankta* (Tirhut and elsewhere south) (*vicia sativa*), it appears in wheat.

अगिया *agiya* (north and east), a weed which burns the rice-plant (from आग *āg*, fire).

उखन्डा *ukhra*,—see हड्डा *hadda*.

उरन्कुस्सी *urkussi*,—see बिहौनिया *bichhautiya*.

ककन्ना *kakna* (Patna, Gaya, and south-east), बनसारी *bansāri* (Shahabad and East Tirhut), a weed which chokes crops.

कठरँगन्नी *kathrengni*,—see रँगन्नी *rengni*.

कनन्वाँ *kanwān*, कन्ना *kanna*,—see काना *kāna*.

कनन्सन *kansan*,—see काँसी *kānsi*.

काना *kāna* (Tirhut, Patna and east), कन्ना *kanna* (north-east Tirhut), कनन्वाँ *kanwān* (Gaya), केना *kena* (West Tirhut and west), a weed which chokes rice (a species of *Coix*).

काँसी *kānsi* (West Tirhut, Patna, Gaya, and the south-east), कास *kās* (Shahabad and North Bihar), कनन्सन *kansan* (Sāran), (*saccharum spontaneum*), a most destructive grass.

केना *kena*,—see काना *kāna*.

कोइल खो *koil kho*,—see गोरखुल *gorkhul*.

खडुका *kharuka*,—see खरन्धूषा *kharthūa*.

खरन्धूषा *kharthūa* (Patna and Gaya), बधुषा *bathua* (generally)
खडुका *kharuka* (North-East Tirhut and Shahabad), मोचही
mochatti (ditto), a weed in opium.

खुरन्का *khurka* or मखैती *machhaiti* (north), also रचारी *ruāri* (Sāran),
a weed in opium. Cf. रचारा *ruāra*.

गङ्गहर *garhar*,—see गाँड़र *gānrar*.

गदन्रो *garhro*,—see गेङ्गहरवा *gerharua*.

गङ्गार *garār*,—see गाँड़र *gānrar*.

गाँड़र *gānrar* (West Tirhut and Patna), गङ्गार *garār* (Tirhut and
east), जमार गङ्गार *jamār garār* (South Munger), गङ्गहर
garhar (South-West Shahabad), a weed which injures
rice (various species of *Coix*).

गेङ्गहरवा *gerharua* (north-west), गदन्रो *garhro* (North Tirhut),
a weed in cereal crops.

गोखुला *gokhula*,—see गोरखुल *gorkhul*.

गोरखुल *gorkhul* (west), बाँसौ *bānsi* (generally), गोखुला *gokhula*
(West Tirhut, Patna, Gaya, and South Munger), कोइल खो
koil kho, a plant which injures rice (*tribulus terrestris*).

चपन्डा *chapra*,—see धुरन्पा *dhurpa*.

चिचन्होर *chichhor*, चिचोर *chichor*, चिचोरी *chichori*,—see लेंड़ई *lenrāi*.

चौपट्टा *chaupatta*,—see पिपन्रा *pipra*.

जंगन्ला *jangla*,—see भिरषा *hirua*.

जमार गङ्गार *jamār garār*,—see गाँड़र *gānrar*.

जन्हार *jamhār*, जान्हार *jāmhār* (Patna and South Munger), जिन्हार
jinhār (South-West Shahabad), and डन्हरो *damharo* (South
Bhagalpur), a coarse hard grass, infesting poor soil
(varieties of *andropogon*.)

जान्हार *jāmhār*,—see जन्हार *jamhār*.

जिन्वाँ *jinwān*, a grass something like दूम *dūbh*, *q.v.*

जिन्हार *jinhār*,—see जन्हार *jamhār*.

भर *jhar*, भरंगा *jharnga*, भार *jhār*,—see भारङ्ग *jhārang*.

भारङ्ग *jhārang* (north-west), भरंगा *jhānga* (Shahabad), भार *jhār* or भर *jhar* (Tirhut and east), a weed which injures rice

भिरवा *jhīrua* (Patna, Gaya, South Munger, and North Bihār).
भिरौवा *jhīrua* (South Munger), भिरवा *jhīrua* (South Bhagalpur), जंगला *jangla* (South-West Shahabad), भीरो *jhīro* (East Tirhut), a weed which chokes rice.

भीरो *jhīro*,—see भिरवा *jhīrua*.

ठोकरा *thokra*,—see बिहौनिया *bichhautiya*.

डहरो *damharo*,—see जन्धार *janhār*.

डर *dar*, डयोरा *deyora*,—see मोंथा *montha*.

डामी *dābhi* (north) a coarse grass, injurious to crops (*cyris indica*).

तितिली *titili*,—see पिपरा *pipra*.

दुधिया *dudhiya*,—see हड्डा *hadda*.

दूस *dūbh* or दूब *dūb* (north and east), also दुबही *dubhi* (south), a grass which overspreads fallow fields (*cynodon dactylon*).

धुरपा *dhurpa* (Patna, Gaya, and South Munger), धुरप *dhurap* (South Bhagalpur), चपन्डा *chapura* (Shahabad), a tough, coarse grass spreading over uncultivated lands, which are inundated yearly (*cynodon dactylon*). It is only removed by digging.

नकन्हिकनी *nakhhikni*,—see रेंगनी *rengni*.

पिपरा *pipra* (Sāran, Patna, and east), पुपरा *pupra* (South Bhagalpur), चौपटा *chaupatta* (South-West Shahabad), तितिली *titili* (generally), a weed in wheat.

पुपरा *pupra*,—see पिपरा *pipra*.

बड़गोहमा *bargohuma* (south and east), a weed in wheat.

बथुवा *bathua*,—see खरन्धुवा *kharthūa*.

बनपियसुवा *banpiyasua*, बनपियाज *banpiyāj*, and बनरसना *banrasna*,—see बथारा *ruāra*.

बनसारी *bansāri*,—see ककना *kakna*.

बसाँही *basānhi*,—see बसाँता *basautā*.

बसाँता *basautā* (West Tirhut and north-west), बसाँही *basānhi* (Tirhut), a weed which injures the spring crops (*acalypha indica* ?)

बाँसी *bānsi*,—see गोरकुल *gorkhul*.

बिहौतिया *bichhautiya* or बिह्वतिया *bichhwatiya* is a parasitic plant which injures the poppy. It is also called भरन्भाँड़ *bharbhāñḍ* in South-West Shahabad, ठोकरा *thokra* in the rest of that district and north of the Ganges, and उरकुसी *urkussi* in South-East Bihār.

भंगरा *bhangra* (West Tirhut, Patna, Gaya, and South Munger), भंगरैया *bhangraiya* (Tirhut and east), भंगरिया *bhengariya* (North Bihār and Shahabad), भंगरिया *bhangariya* (Tirhut) (*verbesina prostrata*), a small creeping-weed with a white flower which injures rice.

भंगरिया *bhangariya*,—see भंगरा *bhangra*.

भरन्भाँड़ *bharbhāñḍ*,—see बिहौतिया *bichhautiya*.

भंगरिया *bhengariya*,—see भंगरा *bhangra*.

मकड़ा *makra* (north and east), a rough coarse grass spreading over uncultivated lands which are inundated yearly. It is only removed by digging (*cynosurus*).

मखैनी *machhaiti*,—see खुरका *khurka*.

मँडेर *mañḍer* (Patna, Gaya, and east), मरार *marar* (South Bhagalpur), मरेन *maren* (Shahabad), a weed which chokes rice.

मोचही *mochatti*,—see खरन्धूआ *kharthūa*.

मोंथा *montha*, also डर *dar* and मौना *mauna* (also in West Tirhut) in the south-east, and डेयोरा *deyora* in South Munger. A coarse grass which grows in uncultivated land and injures the autumn crops (*cyperus rotundus*).

राड़ी *rāri* (north), a coarse hard grass infesting poor soils.

रुआरा *ruāra* (Patna), बनरसना *banrasna* (Gaya and South Munger), बनपियाज *banpiyāj* or बनपियजूआ *banpiyājua* (Tirhut and Shahabad), a weed which grows in opium. Cf. खुरका *khurka*.

रुआरी *ruāri*,—see खुरका *khurka*. Cf. रुआरा *ruāra*.

रँगनी *rengni*, the Mexican poppy (*argemone Mexicana*), a thistle like plant, which overspreads fallow fields. It is also called नकलिकनी *nakhlīkni* or (to the east) कटरँगनी *kathrengni*. It was introduced into India in a cargo

from Mexico within the last hundred years, and is now very common.

लैङ्कर *leñraī* (north-west), चिचोर *chichor* (north and Gaya), चिचोरी *chichori* (Tirhut), चिचन्होर *chichhor* (east), चिचोरो *chichoro* (South Bhagalpur and Tirhut), a weed which chokes rice.

बहुता *hadda* or उखन्डा *ukhra* (West Tirhut and south), or (West Tirhut and Gaya) दुधिया *dudhiya*, a small creeping-plant injurious to crops (*euphorbia hirta*). Cf. also § 1183 for other names.

CHAPTER III.—MISCELLANEOUS.

1076. A stunted crop is बैठल हासिल *baithal hāsīl* north of the Ganges. In Shahabad and West Tirhut it is सितुरियाग्रल *situriyāēl* or ततुरियाग्रल *taturiyāēl*, or in Sāran, सुतरियाग्रल *suturiyāēl*. In Gaya it is टिंगुरियाग्रल *thinguriyāēl*, in Patna भेंटवाँस *bhentwāns*, in West Tirhut and South Munger ठुरियाग्रल *thuriyāēl*, and in South Bhagalpur बिरनियाग्रल *birniyāēl*. A blighted ear is मराग्रल *marāēl* north of the Ganges. In Shahabad it is अबन्दा *abda* or दगन्दार *dagndār*, in Patna and Gaya कोइल *koīl*, and in the south-east मरा *mara*. पैया *paīya* in Gaya and the west, and भोर *bhor* to the north-east, is rice in which the ears have no seed. Blighted millets are called भखियाग्रल *bhakhīyāēl* in the north-west, and भख चट्या *bhakh chatua* in Tirhut. In Shahabad they are खुक्खा *khukkha* or खोजन्डा *khojra*, in Gaya चलंगल *alyal*, and in Patna फुलन्हर *phulhar*.

1077. Crops withered from drought are to the west and in West Tirhut मुआर *muār*; in Gaya they are मोआर *moār*, and in Patna मुआल *muāl*. To the east and in Tirhut they are मरन्हेना *marhena* or मरन्हिना *marhinna*, and in South Bhagalpur also मरा *mara*. An irretrievably spoilt crop is बिग्रल हासिल *bigral hāsīl* north of the Ganges. In Shahabad it is बाँकन्टा *bānkta*, and in Patna चुचुहिया *chuchuhīya*. Scarcity of rain is सुआर *sukhār*.

1078. Failure of seed is बिजन्मार *bijmār* in Gaya and the west. In South Munger it is बीया मार *biya mār*. North of the Ganges it is also निर्विज *nirvij*, निर्वीज *nirvij*, or अबिज *abij*. Other names are बाँहौरा *banjhaura* (South-West Shahabad), बाँही *bāñhi* (rest of Shahabad), बाँहौरी *banjhauri* in Patna, and दैहाप्रब *daihäēb* in South Bhagalpur. In North-East Tirhut there is also कौर जाप्रब *kaur jāēb*, and in East Tirhut भखड़ जाप्रब *bhakar jāēb*.

1079. Crops trodden down by cattle are चङ्गाठ (also spelt चङ्गाठ) *dhāngāth* north of the Ganges, local variants being दङ्गाठ *dangāth* in South-East Tirhut, चङ्गाण्ड *dhāngāṅl* in Sāran, and चङ्गेड़ *dhanger* in West Tirhut and Champāran. In South-West Shahabad they are लहनाण्ड *lahnāṅl*, in Gaya and South Munger खुरखुन *khurkhūn*, and in South Bhagalpur खौंची *khūnchi*. In East Tirhut they are also called निघेस *nighes*.

1080. Crops laid by the wind are called गिरल *giral* or खसल *khasal*. A hot dry wind which burns up crops is to the west called भोला *jhola*, and such crops are known as भोलारल *jholāil* or भौकरल *jhonkral*. To the east it is दाढ़ा *dhārha* or दाढ़ी *dhārhi*. A frosty wind which frost-bites the crops is पाला *pālu* or (to the east) पल्ला *palla*. The same words are used for frost-bite itself, and a frost-bitten crop is पलमरवा *palmarua*. An inundation is दहार *duhār* or बाढ़ *bārḥ*, also बाढ़ि *bārhi* (North-East Tirhut), घाघ *dhādh* (Gaya), आफत *āphat* (Patna), and बोहा *boha* or खार *khār* in the south-east. Morning fogs are कूहा *kūha*, of which optional local variants are कुहेस *kuhes* or कुहेसा *kuhesa* to the west and कुहसा *kuhassa* in South Bhagalpur. कुहेस *kuhes* is also current in North-East Tirhut, and in South-East Tirhut we find कुम्हेस *kūmhes*. A fog in the day-time is धून *dhūn* or धूंध *dhūndh*. Hail-stones are पत्थल *patthal*, पत्थर *patthar*, पाथर *pāthar*, or बनौरी *banauri*, a local variant of the last being बंगौरी *bangauri* or बंगौरिया *bangauriya* in West Tirhut, Patna, and the east.

DIVISION VI.

AGRICULTURAL TIMES AND SEASONS.

1081. The* Bihār agriculturist follows the Hindu year in calculating his seasons. The year is divided into twelve lunar months (मास *mās*, माँस *māṁs*, महिना *mahina*, महिना *mahinna*, or महीना *mahīna*) of 30 days each, and therefore consists of 360 days. Each month is further divided into a first or dark half [किसुन पख (or पख) *kisun pakh* (or *pachehh*)] (commencing with the first day of the wane of the moon), and a second or light half (सुकल पख *sukl pakh*). Roughly speaking, a Hindu month commences at about the 15th of an English month; but as there are thus only 360 days in a year, they begin each year somewhat earlier in the solar year than the year before, till the calendar is brought nearly right every third year by the insertion of an intercalary month (मल्लमास *malnmās*) of 30 days every third year.

1082. Besides the above, another important division of the year must be noticed,—that into lunar asterisms (नखत *nakhat*, नखतर *nachhatr*, or निखतर *nichhatr*). There are 27 of these in each year, and consequently $2\frac{1}{4}$ in each month. Each asterism is not of equal length. The longest is हथिया *hathiya*, which is 16 lunar days. The others range from about 13 lunar days in the dry months to 15 lunar days in the wet. Every agricultural operation commences in a certain asterism, and so it is necessary to know when they occur. The accompanying table shows roughly the relative positions of the English and Hindu months and of the lunar asterisms.

* Part of the following will be found in Carnegie's Kachahri Technicalities.

APPROXIMATE EUROPEAN MONTH.	Name.
Part of September	आसिन <i>Āsin</i> or कुषार <i>Kuār</i> ...
October	कातिक <i>Kātik</i>
November	अगहन <i>Aghan</i>
December	पूस <i>Pūs</i>
January	माघ <i>Māgh</i>
February	फागुन <i>Phāgun</i>
March	चैत <i>Chait</i>
April	बैसाख <i>Baisākh</i>
May	जेठ <i>Jeth</i>
June	अखाद <i>Akhārḥ</i> or असाद <i>Asārḥ</i> ...
July	सावन <i>Sāwan</i> or साशोन <i>Sāon</i> ...
August	भादों <i>Bhādoñ</i>
Part of September	

Months.

Dark half (किमुन पख <i>kisun pakh</i>) and light half (सुकल ख <i>sukl pakh</i>).		Asterisms, of which there are two and a quarter to each Hindu month.
Dark	Light	३ of उत्तरा फगुनी <i>Utra Phaguni</i> .
		हस्त <i>Hast</i> or हथिया <i>Hathiya</i> .
Dark	Light	चितरा <i>Chitra</i> .
		स्वाती <i>Svāti</i> or सिवाती <i>Sivāti</i> .
Dark	Light	बिसाखा <i>Bisakha</i> .
		अनुराधा <i>Anurādha</i> .
Dark	Light	ज्येष्ठा <i>Jeshta</i> .
		मूल <i>Mūl</i> .
Dark	Light	पूरुवा खाट <i>Purba Khārb</i> .
		उत्तरा खाट <i>Utra Khārb</i> .
Dark	Light	सावन <i>Sāvan</i> .
		धनिष्ठा <i>Dhanishtha</i> .
Dark	Light	सतभौषा <i>Satbhikha</i> .
		पूरुब भद्रपद <i>Pūrab Bhadrāpad</i> .
Dark	Light	उत्तर भद्रपद <i>Uttar Bhadrāpad</i> .
		रेवती <i>Reotī</i> .
Dark	Light	अश्विनी <i>Asvini</i> or असनी <i>Asni</i> .
		भरणी <i>Bharṇi</i> .
Dark	Light	क्रितिका <i>Krittika</i> .
		रोहिणी <i>Rohni</i> or रोहिनी <i>Rohini</i> .
Dark	Light	मिर्गशिरा <i>Mirgshira</i> or मिर्गिडा <i>Mirgidāh</i> .
		अर्द्रा <i>Aradra</i> or अद्रा <i>Adra</i> .
Dark	Light	पुनर्वस <i>Punarvas</i> .
		पुष्य <i>Pukh</i> or चिरेया <i>Chiraiya</i> .
Dark	Light	अश्लेषा <i>Asres</i> or असलेखा <i>Aslekha</i> .
		मघा <i>Maggha</i> .
Dark	Light	पूरुवा फगुनी <i>Purba Phaguni</i> .
		३ of उत्तरा फगुनी <i>Utra Phaguni</i> .

1083. The year current in Bihār is the *Fasli* year, which commences with the Hindu month of *Āsin*. The year is also popularly* divided into three seasons, viz. the hot (गरमी *garmi*), the wet (बरखा *barkha*), and the cold (जाड़ा *jāra*). The hot season commences in फ़ागुन *Phāgun*, the wet in अषाढ़ *Akhārh*, and the cold in कातिक *Kātik*. The following rhymes, some of which will be found also in Carnegy's *Kachahri Technicalities*, are current over the greater part of Northern India, and show the various seasons for agricultural operations.

1084. Cultivation commences in Jeth, in the asterism of Rohini, when ploughing and sowing begin. The rain of Mingsira is not good, and hence no sowing is done in that asterism. In Aradra sowing is recommenced and transplanting is done for the winter (*aghani*) crop. This goes on into Punarbas and Pukh if the rains are late. In Magha and Purba Phaguni the *urid*, *kurthi*, and other pulses are sown. In Hathiya rain is very important, both for the winter crops and for the sowing of the spring (*rabbi*) crops. In former days (say cultivators) the rains used to stop in Swāti, which was very good for the crops, but now they end in Hathiya. So valuable is the rain of Swāti that any drop which falls during that asterism into a pearl-oyster becomes a pearl. That is how pearls are made. The rain in Chitra, on the contrary, is very bad.

मग्घा लगवे घग्घा, सिवाती लावस टाटी ।
कहतारी हाथी रानी, हम हूँ अवात बाटी ॥

Maggha lagāwe ghaggha, sivāti lāvas tāti,
Kahtāri Hāthi rāni, ham hūñ āwat bāti.

—Maggha brings rain-storms, Swāti brings a screen (*i.e.*, rain stops), and Queen Hathiya tells (by her thunder) that she is coming.

फ़ागु करार चैत चुक किर्तिक नद्धि तार ।
स्वाती नद्धि माख तिल कहि मग्न डाक गोधार ॥

Phāgu karāi, chait chuk, kirttik natthahi tār,
Swāti natthahu mākh til, kahi gae Dāk Goār.

Astrologers and poets count six seasons, but the above is the popular division.

—If it rains in the month of Phāgun, *urid* is spoilt; if in the month of Chait, lemons;* if in the asterism of Krittika, the toddy palms; and if in that of Swāti, beans and sesamum, saith Dāk, the Gowāla.

जौं बरसे बैसक्खा राज ।
एक धान में दोबर चाज ॥

Jauñ barse Baisakkha rāu,
Ek dhān meñ dobar chāu.

—If King Baisākh (April–May) rain, every grain of toddy will produce two of rice.

क्रित्तिका चए छौ ले सूए ।
जौं रोहिनी नाहिं कादो करे ॥

Krittika chūe chhau le sūe,
Jōñ Rohini nāhiñ kādo kare.

—If it rains in Krittika, there will be no rain for the six following asterisms, provided Rohini makes no mud.

Krittika is the best asterism for sowing *chīna* (*panicum frumentosum*): hence they say in Tirhut—

जब जनिहट खरचाक हीन ।
क्रित्तिका में सँ बोइहट चीन ॥

Jab janiha kharchāk hīn,
Krittika meñ sūñ boihṭ chīn.

—If you find your stock of food becoming exhausted, sow *chīna* in *Krittika*.

मिरगसिरा तबय रोहिनि लबय अरद्रा जाय बद्बुदाय ।
कहै डाक सुनु भिल्लरि कुत्ता भात न खाय ॥

Mirgsira tabay Rohini labay aradra jāy budbudāy
Kahai Dāk sunu Bhillari, kutta bhāt na khāy.

—If Mirgsira is hot, Rohini rains, and Aradra gives a few drops, saith Dāk, hear, O Bhillari, (rice will be so plentiful that) even dogs will turn up their noses at it.

* चुक *chuk* is a mess of lemons kept for fermentation, and is here applied to the fruit on the tree.

1085. The rain of Aradra (middle of June) is of considerable importance to the future crops : thus—

अद्रा मँस जे बोए साठी ।
दुख के मार निकालत छाठी ॥
Adra māns je boe sāthi,
Dukh ke mār nikāla lathi.

—If you sow sixty-day rice in Aradra, you strike distress with a club and drive it away.

आदि न बरसे अद्रा हस्त न बरसे निदान ।
कहचिँ डाक सुतु भिल्लरि भए किसान पिसान ॥
Ādi na barse aradra, hast na barse nidān,
Kahachiñ Dāk sunu Bhillari bhac किसान पिसान.

—If Aradra does not rain at the commencement, and Hathiya at its end, saith Dāk, hoar, O Bhillari, the cultivator is crushed.

And—

बहुत बरसे अद्रा उतरत बरसे हस्त ।
कतेक राजा दाँड़े, रहे अनन्द गिरहस्त ॥
Charhat barse aradra, utrat barse hast,
Katek rāja dāṅṅe, रहे अनन्द गिरहस्त.

—If it rain when Aradra commences and when Hathiya is ending, no matter how much rent may be demanded, the householder is still happy.

अद्रा बरसे सब किछु हँ ।
एक जवास पतर बिन भँ ॥
Aradra barse sabh kichhu hān
Ek javās pater bin bhān.

—If Aradra rains everything grows (*lit. is*) : only one, the *javās* (*Hedysarum alhagi*), loses its leaves.

1086. Aradra and Punarbas are the two main asterisms of the month of Ākhārḥ (June–July). This is the great month of the year for finishing the preparation of the fields, as the proverb says, जेकर बनल अखदवा रे तेकर बारहो मास *jekar banal akharwa re tekar bārahō mās*, —he whose fields are ready in *Ākhārḥ*, is ready also all the year round. If the rains are late, paddy sowing goes on as late as Punarbas or even Pukh, but this is rarely successful. These last two asterisms are usually devoted to transplanting, and not to sowing.

पुख पुनरबस बोए धान ।
मग्घा असलेखा कादो धान ॥

Pukh punarbas boe dhān,
Magghā aslekha kādo sān.

—Sow paddy in Pukh and Punarbas, and in Maggha and Aslekha mix thoroughly the mud (*i.e.* prepare the fields).

अरदरा धान, पुनरबस पैया ।
गेल, किसान, जी बोए चिरैया ॥

Aradra dhān, punarbas paiya.
Gel, kisān, jī boe chiraiya.

—Paddy sown in Aradra turns to plenty, in Punarbas it has empty ears, and sown in Pukh it turns to nothing.

1087. After Akharh (June–July) comes Sāwan or Sāon (July–August), to which the following rhymes apply :—

साञ्चोन सुकला सप्तमी बपि कै जगहिँ भान ।
तौँ लगि मेघा बरसे जौँ लगि देव उठान ॥

Sāon sukla saptamī bhapi kai jaghiñ bhān.
Tauñ lagi megha barse jauñ lagi deh uṭhān.

—If on the morning of the seventh day of the bright half of Sawan the sun rises obscured by clouds, it will rain up to the festival of the *Deh Uṭhān* (11th of the light half of Kātik, *i.e.* early in November).

साञ्चोन सुकला सप्तमी उग के लुकहिँ सूर ।
हाँको पिघा हर बरद बरसा गेल बड़ि दूर ॥

Sāon sukla saptamī, ug ke lūkahīñ sūr,
Hānko piya har barad, barṣa gel bari dūr.

—If on the same day as that above mentioned the sun rises (clear) and afterwards hides itself behind clouds, drive away, my dear, your plough and bullocks, for the rain is very far off.

साञ्चोन सुकला सप्तमी, उदै जौँ देखे भान ।
तुम जाओ पिघाँ मालवा हम जैबौँ मुलतान ॥

Sāon sukla saptamī, udai jōñ dekhe bhān,
Tum jāo piya Mālwa, ham jāibōñ Multān.

—A cloudless morning on the same day (is a sure sign of drought). My dear (let us leave the country,) I am going to Multan, and you can go to Malwa.

साखीन सुकला सप्तमी रैनि होंहि मसियार ।
कह भडुर सुनु भडुरि परबत उपजय सार ॥

*Sāon sukla saptami, raini hoñhi masiyār,
Kah Bhaddar sunu Bhaddari, parbat upjay sār.*

—If on the same date the night is dark, saith Bhaddar, hear, O Bhaddari, excellent crops will grow even on a mountain.

साखीन सुकला सप्तमी, जोँ गरजे आधी रात ।
तुम जाओ पियाँ मालवा, हम जौँ गुजरात ॥

*Sāon sukla saptami, joñ garje ādhī rāt,
Tum jāo piya Mālwa, ham jaiñ Gujrāt.*

—If on the same date it thunders at midnight (there will be a drought), you must go to Mālwa and I to Gujrat.

करके भौँजे कंकरी, सिङ्ग गरजे जाग्र ।
कह भडुर सुनु भडुरि कुत्ता भत न खाग्र ॥

*Karke bhāñjai kankri, singh garjai jāe,
Kah Bhaddar sunu Bhaddari, kutta bhāt na khāe.*

—“If in Cancer (Sāwan, July–August) the gravel is wet, and Leo (Bhādon, August–September) passes by with thunder,” saith Bhaddar, “hear, O Bhaddari, rice will be so plentiful that even dogs will refuse it.”

साखीन पखवा भादव पुरवा आसिन बहे रिसान ।
कातिक कन्ता सिकियो न डोखे कतय के रखबध धान ॥

*Sāon pachhwa, Bhādab purwa, Āsin bahe risān,
Kātik, kanta, sikio na dole katay ke rakhbah dhān ?*

—If the west wind blow in Sāwan, the east in Bhādon, and the north-east in Āsin, and if there is so little wind in Kātik that even the reeds do not shake, where, my dear, will you have room to keep your rice? (i.e., you will have a bumper crop).

साखीन मास बहे पुरवेधा बँचह बरद कीनह गैया ।

Sāon mās bahai purwaiya, benchh barad kīnah gaiya.

—If the east wind blow in Sāwan, sell your bullocks and buy cows (it will be no use trying to plough).

साओनक पख्वा दिन दुर चारि ।
चूल्हीक पाखा उपजे सारि ॥

Sāonak pachhwa din dūi chāri,
Chūlhhīk pāchha upje sāri.

--If the west wind blow in Sāwan for only two or three days, rice will grow even behind your hearth.

साओन पख्खा महि भरे ।
भादों पुरवा पथल सङ्गे ॥

Sāon pachhwa mahi bhare,
Bhādoñ purwa puthal saṅge.

--If the west wind blow in Sāwan, the land will be flooded; and if the east wind blow in Bhādoñ, (it will rain so that) the very stones will melt.

जे न भरे असरेखा मग्घा ।
फेर भरे असरेखा मग्घा ॥

Je na bhare Asrekha Maggha,
Pher bhare Asrekha Maggha.

--That which is not filled up with water in Asres and Maggha has no chance of being filled up till they come again next year.

1088. To Bhādoñ (August–September) the following apply:—

South Munger—

पुरवा रोपे पूर किसान ।
आधा घघरी आधा धान ॥

Purwa rope pūr kesān,
Ādha ghaghri ādha dhān.

--If a cultivator does not finish transplanting before Purwa (*i.e.* Purba Phaguni), half his crop will be paddy and half chaff.

जौं पुरवा पुरवैया पावे । सुखले नदिया नाओ बहावे ॥

Jauñ purwa purvaiya pāve, sukhle nadiya nāo bahāve.

--If the east wind blows in the asterism of Purwa (*i.e.* Purba Phaguni), there will be so much rain that ships will float in the dried-up beds of rivers.

Closely connected with this is the following :—

पुरवा पर जीँ पछवा बहै । बिहंसि रीँड बात करै ॥
 ग्रह दोनों के रहै बिचार । ज बरसे ई करै भतार ॥

Purwa par jāuñ pachhwa bahai, bihañsi rāñr bāt karai,
Eh donoñ ke ihai bichār ù barsai ì karai bhatār.

—If the west wind blows during Purwa, and if a widow chats and smiles, from these facts you may judge that in the first case it will rain, and in the second case she is going to marry a second time.

With this may be compared—

तीतिर पख मेघा जड़े, ओ बिधवा मुसुकाए ।
 कहे डाक सुनु डाकिनि, ज बरसे ई जाए ॥

Titir pakh megha ãre, o bidhwa musukãe.
Kãhe Dãk sunu Dãkini, ù barse ì jãe.

—“When the clouds fly like the wings of the partridge, and when a widow smiles,” saith Dak, “hear, O Dakini, the one is going to rain and the other to marry.”

सुक करे बदरी सनीचर रहै छाए ।
 ऐसन बोले भड्डरि बिन बरसे नहिँ जाए ॥

Sūk karẽ badri sanīchar rahẽ chhãe,
Aisan bole Bhaddari bin barse nahĩ jãe.

—A cloudy sky on Friday and Saturday is a sure precursor of rain.

साँचोन के पुरवा, भादों पक्किमा जोर ।
 बरधा बँचठ सामी, चलठ देस का ओर ॥

Sãon ke purwa, bhãdoñ pachhima jor,
Bardha bẽcha sãmi, chala des ka or.

—My husband, let us sell our bullocks and leave the country if there is east wind in Sãon and a strong west one in Bhãdoñ.

The following is current in Tirhut :—

कुसी आमवास चौठी चान ।
 अब की रोपवठ धान किसान ॥

Kusi amãwas chauthi chãn,
Ab kī rop̄ṣa dhãn kisãn.

—After the *Kusi Amāwas* (the festival of the 15th Bhādon, on which Brāhmins dig *kus* grass), and the *Chauk Chanda* (the moon of the 19th of Bhādoñ, O cultivator! you neede not plant out paddy.

उतरा में जनि रोपड़ भैया ।
तीन धान होए तेरह पैया ॥

Utra meñ jani ropahu bhaiya,
Tin dhān hoe terah paiya.

—Do not transplant in Utra Phaguni, for you will only get three grains to thirteen empty husks.

रातुक कागा दीनुक सिघार ।
कि भरौ बादर कि उपटार ॥

Rātuk kāga dīnuk siyār,
Ki jhari bādar ki uptār.

—If the crow speak by night, and the jackal by day, there will be either a rain-storm or an inundation.

बौबा बौबा बड़े बत्तास ।
तब होला बरखा के आस ॥

Abū bābū bahū batās,
Tab hola barkha ke ās.

—When the wind blows from all four quarters, there is hope of rain.

1089. To Āsin (September-October) the following apply :—

हथिया बरसे तीन होत बा, सक्कर, साली, मास, ।
हथिया बरसे तीन जात बा, नील, कोदो, कपास ।

Hathiya barse tin hot bā, sakkar, sāli, mās,
Hathiya barse tin jāt bā, til, kodo, kapās.

—Rain in Hathiya produces three things,—sugar-cane, rice, and pulse; and destroys three things,—sesamum, *kodo*, and cotton.

With this may be compared—

अदरा गेल तीन गेल, सन साठी कपास ।
हथिया गेल सब गेल, आगिल पाच्छिल चास ॥

Adra gel tīni gel, san, sāthi, kapās ;
Hathiya gel sabh gel, āgil pāchhil chās.

—Want of rain in Aradra destroys three crops,—hemp, sixty-day rice, and cotton. But by want of rain in Hathiya every thing is ruined, both what has been sown and what will be sown.

हथिया बरिसे, चितरा मँडुराय ।
घर बैसे धनहा रिरियाय (or अग्राय) ॥

Hathiya barise, chitra meṅṅrāy,
Ghar baise dhanha ririyāy (or agrāy).

—If Hathiya rains, and (the clouds of) Chitra hover about, the paddy-cultivator sits at home and utters cries of joy.

चितरा बरसे माटी मारे ।
आगे भाइ गेरु के कारे ॥

Chitra barse māṭī māre,
Āge bhāi geru ke kāre.

—Rain in Chitra destroys the power of the soil and is likely to produce blight.

आधा चित्रा राइ सुराड ।
आधा चित्रा जौ केराड ॥

Ādha Chitra rāi surāḍ.
Ādha Chitra jau kerāḍ.

—In one-half of Chitra sow mustard and radishes, and in the other half barley and pease.

1090. To Katik (October–November), the following apply :—

एको पानि जौ बरसे खानी ।
कुरमिन पहिरे सोना पानी ॥

Eko pāni jōṅ barse khānī,
Kurmin pahire sona pānī.

—If a single shower come in Swāti it enriches people so much, that even Kurmi women get golden earrings to wear.

वेद बिदित ना होखे आन । बिना तुला नहिँ फूटे धान ।

सुख सुखरानी देव उठान । तकरै बरहै करह नोमान ॥

तकरै बरहै खेत खरिधान । तकरै बरहै कोठिए धान ॥

Bed bidit na hokhe ān, bina Tula nahīṅ phūṭe dhān,

Sukh sukh-rānī dev uṭhān, takrai barhai karah nomān,

Tukrai barhai khet kharidhān, takrai barhai kothie dhān.

—What has been written in the Vedas cannot happen otherwise, and paddy cannot ripen before the balance (*i.e.* *Libra* = *Kātik* = October–November). From the festival of the *Sukhrāti* (*i.e.* the *Diwāli*) to the *Deb Uthān* (11th of the light half of *Kātik*) there will be happiness. On the twelfth day after that, hold the festival of eating the new grain; on the twelfth after that, heap up the corn on field and threshing-floor; and on the twelfth after that, put the grain in the store-house.

1091. The following are the signs of the stoppage of the rains:—

बप के उगे तो क्या भये, निरमल रैनि करन्त ।

कीये जल देखिहठ सगरा, कामिनि कूप भरन्त ॥

Chhap ke ugai to kya bhaye, nirmal raini karant,

Kāye jal dekhiha sagra, kāmīni kūp bhārant.

—It matters little if the sun rises obscured by clouds, because when the nights are clear (the rains will stop). You will only find water in the sea, and women will have to go to the wells for water.

रात निबद्ध, (or रातुक चकमक) दिन के क्या ।

कहाँ घाघ जे बरखा गया ॥

Rāt nibaddar (or rātuk chakmak), din keñ chhaya,

Kahēñ Ghāgh je barkha gaya.

—If you see a cloudless night and a cloudy day, be sure, says Ghagh, that the rains are at an end.

बोली लुखरी, फूले कास ।

अब नाहीं बरखा के आस ॥

Boli lukhri, phūle kās,

Ab nāhīñ barkha ke ās.

—The barking of the fox and the flowering of *kās* grass are signs of the end of the rains.

जगे अगस्त बन फूले कास ।

अब नाहीं बरखा के आस ॥

Uge agast ban phūle kās,

Ab nāhīñ barkha ke ās.

—The appearance of the star Canopus and the flowering of the *kās* grass in the forest are signs of the end of the rains.

काँसी कूसी चौठ के चान ।
 अब का रोपबठ धान किसान ॥
Kānsi kūsi chauth ke chān,
Ab ka ropba dhān kiśān.

—If the *kās* grass and the *kūs* grass flower on the fourth of the light half of Bhādon, why do you plant out, O cultivator (for the rains are stopped) ?

1092. The following refer to the dry season :—

अगहन दोबर, पूस खौड़ा ।
 माघ सवाई, फागुन बरसे घर छू के जाई,
Aghan dobar, Pūs dyaurla,
Māgh sawāi, Phāgun barse gharhu ke jāi.

—If it rains in Aghan, you will get double an average crop; if in Pūs, one and a half; if in Māgh, one and a quarter: but it in Phāgun, then even (the seedlings which you brought from) your house will be lost.

अगहन जे बरसे मेघ,
 धन खो राजा धन खो देस ॥
Aghan je barse megh,
Dhan o rāja dhan o des.

—Happy are the king and people when it rains in Aghan.

पानी बरसे आधा पूस ।
 आधा गेहूँ आधा भूस ॥
Pāni barse adha Pūs,
Adha gehūñ adha bhūs.

—Rain in the middle of the month of Pūs (*i.e.* early in January) will give you half wheat, half chaff.

माघ के गरमी, जेठ के जाड़, ।
 पहिला पानी भर गैल ताड़ ।
 घाघ कहेँ हम खोबीँ जोगी ।
 कुआँ का पानी धोइहेँ धोबी ॥
Māgh ke garmi, Jeth ke jāṛ,
Pahila pāni bhar gail tāṛ,
Ghāgh kahen ham hobauñ jogi,
Kūān kā pāni dhoihen dhobi.

—Heat in Magh (January–February), cold in Jeth (May–June), and the tanks filled with the first fall of rain (are signs of a drought). I'll become a beggar, says Ghāgh, and the washermen will wash with well-water.

चैत के पक्षेया भादों के जला ।

भादों के पक्षेया माघ के पखा ॥

Chait ke pachhea, Bhādoñ ke jalla,

Bhādoñ ke pachhea, Māgh ke palla.

—The west wind in Chait (March–April) means rain in Bhādoñ (August–September), and the west wind in Bhādoñ means frost in Māgh (January–February).

1093. It will now be of advantage to compare the above with a native account of the behaviour of the asterisms preceding the famine of 1873-74. The poet Phatūri Lal, in his tale of the famine, says as follows :—

June 1873.—ROHNI is the first asterism of the rainy season ; but,

Rainfall in Tirbut about
4 inches.

as it came, it departed without rain.

MIRGASIRA fulfilled our hopes, for it gave a few drops of rain and departed.

July.—ARADRA passed by with great majesty, thundering on every side.

Rainfall about 6½ inches,
of which 4 inches were
in the second week and 1½
inches in the last week.

PUNARBAS is a very holy asterism, but it was also a miser.

PUKHI saved the face of the earth, but it became the end of the rains.

August.—ASRES rained upon such of the seedlings as did rise.

Rainfall about 4½
inches.

MAGHA was as poor as a beggar.

September.—PURBA PHAGUNI gave no proof of his existence by rain.

Rainfall about 4 inches.

UTRA PHAGUNI did not give even a drop to swear by.

October.—HATHIVA was like an elephant (*hāthi*) who put his trunk in his mouth.

Rainfall nil.

CHITRA was only a robber and a murderer.

November.—SWĀTI was put to public disgrace.

Rainfall nil.

DIVISION VII.

CATTLE AND OTHER DOMESTIC ANIMALS.

CHAPTER I.—CATTLE GENERALLY.

1094. Cattle generally are known as मवेशी *maवेशी*, माल *māl*, or माल जाल *māl jāl*. Other names are चौसा *chau* north of the Ganges, घूर *dhūr* in Patna and Gaya, and बरन्धा *baradhā* in South-West Shahabad. A head of cattle is रास *rās*, and in Patna and Gaya also घूर *dhūr*. Horned cattle, exclusive of buffaloes, are गोरू *goru* or गाय गोरू *gāy goru*; also घूर डाँगर *dhūr dāngar* in Patna and Gaya. In Sāran डाँगर *dāngar* means cattle worn out from old age. In North-East Tirhut they are called लटल *latal*. A worn-out, useless cow or buffalo is said to be टुटाह *tutāh* or टूट गैल *tūt gail* north of the Ganges, or in North-West Tirhut बेहवाल *behwāl*. In Patna the term is थौसा *thausa*, in Shahabad थऊसल *thahusal* or थौसल *thausal*, in Gaya नकादर *nakādar*, and in South Bhagalpur उठानो *uthāno*. Dead cattle are डाँगर *dāngar* in Shahabad and मरी *marī* in East Bihār.

CHAPTER II.—BULLS.

1095. A bull is साँद *sāndh* when branded with sacrificial marks and let go, and धाकर *dhākar* when not so branded. चौभर *chaubhar* (Patna and Gaya) or धकारन्होह *dhakarन्होह* is an imperfectly castrated bull, and बिनन्हामो *binhāmo* is a bull to the south-east.

CHAPTER III.—BULLOCKS.

1096. A bullock is बरघ *baradh*, also in Patna, North-West Tirhut, and in Shahabad optionally बरद or बड़द *barad*. To the west it is also called बैल *bail*, and in Gaya घूर *dhūr* or पैरा *paira*. Plough-bullocks are called हराथी *harāthī* to the east. The pair are called जोड़ा *jora*. In a team of three bullocks the wheelers are called घूरी *dhūri*

or धुरिया *dhuriya* to the west, and जोड़ी *jori* to the east. The leader is बौड़ *binr* or बिड़िया *binriya* to the west, and जिड़ी *jhitti* or नाटा *nāta* to the east.

1097. A yoke of well-bullocks is called मोटाहा बरध *motha baradh*. The bullock which works blindfolded in an oil or sugar-cane press is called नाटा *nāta* or कोखुआ बैल *kolhua bail*. When there is ploughing going on, or a cart being pulled by the aid of three bullocks, of whom only two are yoked at a time while the third one rests, the three are called तेधुरा *tedhura* or (in East Tirhut) तेधरी *tedhri*, or in Patna टेपटा *tepta*. Similarly when there are four bullocks, of whom two rest while two work, the team is called चौखर *chaukhar* or चौखरिया *chaukhariya* or चरन्बर्धा *charbardha*, or in South-West Tirhut फेरन्वार *pherwār*. In the case of ploughing, the boy who looks after the unemployed bullocks is called in North-East Tirhut अनवाह *anwāh*.

1098. Bullocks are distinguished by various peculiarities, such as the following:—

A bullock unbroken to work is अदारी *adāri*, also अदर *adār* in Tirhut, in Shahabad, and in South Bhagalpur. In Patna and Gaya he is औदार *audār*, in South Munger अबौ *aboñ*. One that sits down at work is परवा *parua* to the west, and north of the Ganges कोड़ि *korhi*.* In South-West Shahabad he is गरिअर *gariār*, in Shahabad and Gaya गर *gar*, and in Patna मनकोड़ी *mankorhi*. A vicious bullock is मरन्काह *markhāh*, also मरन्काहा *markhanda* in Patna, मरन्काहे *markhanno* in East Bhagalpur, and मरन्कान *markhan* in Gaya. In South West Shahabad the words मरन्काहा *markaha* and लनका *latha* are used. A shying bullock is फेफरियाह *phephriyāh* to the north and west and चिहकार *chihukār* or हरन्काह *harkāh* north of the Ganges generally. In South-West Shahabad he is बँदिया *bandiya*, in the rest of the district मन्हार *manjhār*, in Patna and Gaya भरन्काहा *bharkāha*, and to the south east हरन्काहा *harkāha*. To butt is ऊर पेटल *hur petal* in the west and मार *mārāb* in Tirhut. In Patna and the east it is दूस मारब *dhūs mārāb* and to the south-east दूस मारब *dhūs mārāb* or दूस मारब *dhūsa mārāb*. In Gaya it is दुसियाअब *dhusiyāēb*, and such a bullock is दुसमार *dhusmār* or दुसियाहा *dhusiyāha*. To break in cattle is तेवारे जोतल *tewāre jotāb* to the west. In Tirhut it is पाठ लगान *pāt lagāēb* or जोतब *jotāb*. In East Tirhut it is पाठ गुमान *pāēt ghumāēb*, and in Gaya पीरी *pīri* or जोतब *pīri meñ jotāb*. In Shahabad निकासल *nikāsal*, in Patna उधराना

* Compare the proverb कोड़ि बरद के फेफड़ि बहुत *korhi barad keñ phēphur bahut*,— it is the lazy bullock that snorts and shies.

daghrāëb, in Gaya दहराएब *dahrāëb*, in South Munger गोहराएब *gohrāëb*, and in South Bhagalpur छटियाएब *chhatiyāëb*, mean to cause an animal to get up and to drive it along a village-road.

1099. A stunted bullock is ननकिरवा *nankirwa*, नाटा *nāta*, or नटवा *natwa*. A dwarf bullock is गैना *gaina*.

1100. A bullock whose horns project in front is घोंचा *ghoncha* north of the Ganges and in Patna and South Bhagalpur, also घोंपा *ghompa* in East Tirhut. In Shahabad it is घोंचवा *ghonchwa*, in Gaya घोंघर *ghonghar*, in Patna also घोंगरा *ghongra*, and in South Munger घोंघरा *ghonghra*.

1101. A bullock one of whose horns is erect while the other hangs down is सरगपताली *saragpatāli* (literally pointing to heaven and hell) or सरङ्गपताली *sarangpatāli*. He is also called डेब *deb* in Champaran and West Tirhut, कंससुरी *kansāsuri* in South-West Shahabad, पताल सिङ्गी *patāl singhi* to the south-east.

1102. A bullock whose horns join in the centre is गौसिङ्गी *gausinghi* in South-West Tirhut, and सिंगजुटा *singjutta* or सिंगजूटल *singjūtal* generally.

1103. A bullock whose horns are loose and are turned down is called मैना *maina*, or in Patna and the south-east मैन *main*.

1104. A bullock whose horns are curled like a ram's is भेंड़वा *bheñrwa*, भेंड़ *bheñr*, or मँडवा *menṭwa*

1105. A bullock one of whose horns turns to the right and the other to the left is चातर *chātar*, or चतरा *chatra* when they are small and flat. When they are large, he is called फठाह *phathāh* or फटहा *phatha*. In North-East Tirhut he is फरकभाड़ा *pharakjhāra*.

1106. A bullock with stunted horns is मुठरा *muthra* or मुठिया *muthiya* generally, but in Shahabad it is मुठाल *muthāl* or मुठल *muthal*, and in Gaya मुठरिया *muthariya*.

1107. A bullock with no horns is मुंडेड़ा *munrera* in Saran, मुण्डा *bhunda* in Champaran, भूँड़ा *bhūnra* or भुँड़वा *bhūnra* in Shahabad, मूँड़ा *mūnra* in North-East Tirhut, and मुण्डा *munda* in Gaya and the rest of Tirhut, मुण्डला *munṭa* in South-East Tirhut, Patna, and South Munger, and मूड़ा *mūra* in South Bhagalpur. Other names are डुँड़िया *dunriya* in South-West Shahabad and ठूठा *thūtha* in South-East Bihar.

1108. A bullock with only one horn is एकसिङ्गा *eksingha* or सिङ्गहा *singhtutta*.

1109. When a bullock has a broken tail he is called बाँड़ *bānr* or बाँड़ा *bānra* north of the Ganges and to the south-west, also नाहा *nārha* in East Tirhut and the south-east. In Gaya and Champāran he is बण्डा *banda*, and in Patna लण्डा *landha* or बाण्डा *bandha*. In South Munger he is लाँड़ा *lānrha*. The opposite to this is पौँहवाला *ponchhwāla*.

1110. A bullock with its ears covered with long hair is आबर *hābar* to the east and अबर *jhabhra* to the west. One with crooked eye-brows is भौँआँ टेर *bhauñāñ ter* or भौँआँ डेर *bhauñāñ der*, also in South Munger भाँवाँ डेर *bhāñwāñ dera*.

1111. A bullock not used for agriculture because it has excrescences (representing Shiva) on its body, but purchased by religious mendicants, is known as जटवा *jatahu* or बसहा *basaha*. Other local names are जटवावा *jathāva* in Shahabad and जटो *jato* in South Bhagalpur. It is the bullock ridden by Shiva.

1112. A छेरुआ *chherua* or बधिया *badhiya* is a castrated animal, as distinguished from the साँड़ *sānrh* or entire bull devoted and let go. The sacred marks placed on this last are the तिरगुल *tirsul* or trident and the चक्कर *chakkar* or diseus.

1113. The following rules for selecting cattle are current throughout Bihar :—

बैल बेसाहै चललह कान । बैल बेसहिह दू दू दान ॥
 काक कसौटी साँओर बान । देहाड़ि किनिह मति आन ॥
 जब देखिह रूपधौर । टाका चारि दीह उपरौड़ ॥
 जब देखिह मैना । तब ग्रहि पार सँ करिह बैना ॥
 जब देखिह बैरिया गोल । उठ बैठ कै करिह मोल ॥
 जब देखिह करियावा कान । कैला गोला देखह जानु दान ॥

Bail besāhai chālalah kant, bail besahiha dū dū dant,

Kākh kasauti sāñor bān, ñ chhāri kinīha mati ān.

Jab dekhīha rūpadhaur, tāka chāri dīha uparaur,

Jab dekhīha maina, tab chi pār san kariha baina.

Jab dekhīha bairiya gol, uth baith kai kariha mol,

Jab dekhīha kariyawa kant, kaila gola dekhah janu dant.

—My dear, you have started to buy a bullock, be sure and buy one with only two teeth. Do not buy any which is not some shade of grey; but if you see a pure white one, you may

advance your price four rupees. If you see one with loose horns, give handsel without crossing the road (to look at it more carefully, *i.e.*, it is sure to be a good one). If you see one with a red head and a light red body, don't buy till you have had a good look at it. But, my dear, if you see a black, or a yellow-grey, or a red one, don't take the trouble to look at its teeth.

The following is a warning against two kinds of bullocks :—

सरग पताली भौँचाँ डेर ।

अपन खाय, परोसिया हेर ॥

Sarag patāli bhauñāñ ter,

Appan khāy parosiya her.

—A bullock with horns pointing up and down, or one with crooked eye-brows, injures its master and the neighbours as well.

CHAPTER IV.—COWS AND BREEDING.

1114. A cow is गौ *gau* or गाय *gāy*. One that has had one calf is known as a पहिलोठ or पहिलौँठ गाय *pahiloṭh* or *pahilaunth gāy*. Sometimes these words are spelt with ट *t* instead of with ठ *th*. A cow or buffalo within six months after calving is घेन *dhen* generally. In North-East Tirhut it is घेइन *dheïn* or घेनु *dhenū*, in Patna and the south-east घेनु *dhenū*, and it is also देनु *dhenū* in Patna. After this she is बकेन *baken*, or (in Shahabad and the south-east) बकेना *bakena*. A cow that calves yearly, or that never stops milking, is पुरहिया *purāhiya* north of the Ganges. A cow that breeds when five years old is पचाड़ु *pachār*. In Shahabad and Patna she is धनपुरही *dhanpurahi*, in Patna (also), Gaya, and South Munger बरन्साइन *barsāin*, and in South Bhagalpur पोरैया *poraiya*. A barren cow is बहिला *bahila* generally, also ठहरा *thahra* in South-West Shahabad.

1115. To be covered by a bull is बरन्धियाएब *bardhiyāēb* or परियाएब *pariyāēb*, and also south of the Ganges बरन्दाएब *bardāēb*. Another general term is पाल खाएब *pāl khāēb*. To copulate (of animals) is बाहब *bāhab*, also in North-East Tirhut ओहाएब *ohāēb*. In regard to buffaloes, भंसाएब *bhainsāēb* may also be used, and of a goat हगन्राएब *chhagrāēb* to the west.

1116. A cow in calf is बरदाप्रल *bardāel* or गभिनि *gābhini*. In South Bhagalpur she is फरली *pharli*. The act of calving is बियान *biyān* or बियाना *biyāna*. South of the Ganges भोल देब *jhol deb* is to give birth to a number of young, e.g. in South-West Shahabad a man was heard saying हमार बेरी दू भोल बच्चा दिहलस है *hamār chheri du jhol bachcha dihlas ha*,—my goat has dropped kids on two occasions.

* 1117. A cow that is a good milker is दुधार *dudhār* or दुधारि *dudhāri*.^{*} One which gives milk for one and a half years is देवह *dewarh*, or in North-East Tirhut बरगू *barghu*. A cow or buffalo that has gone five months in calf, or that has given milk for five months, is सहरोस *sahros* north of the Ganges, and also पुरहिया *purāhiya* in North-East Tirhut. One that gives little milk is चोँदी *chonrhī* or चोँद *chonrh*, also चोरनी *chorni*, and in Tirhut धोँह *dhonchh*. In Shahabad it is नठहर *nathāhar*, and in South Bhagalpur चोँड़ *chaunr*. A cow that kicks at the time of milking is रन्ककट *karkat*, or in Tirhut लथराह *lathrāh*.

CHAPTER V.—CALVES.

1118. A calf as long as it is unweaned is लेहू *leru*. A male calf is बाहा *bāchha*, बहना *bachhua*, or बहनु *bachhru*, and a female calf बाही *bāchhi* or बहिया *bachhiya* when they are from 1½ to 3 years old. When a calf has two teeth, it is दोहान *dohān* north of the Ganges and in Shahabad. In the rest of Shahabad it is दुदन्त *dudant*, and elsewhere दोदन्त *dodant* or दोदना *dodanta*. In West Tirhut it is दोख बैल *dokh bail*. When it has not yet got its true teeth it is called उदन्त *udant*, or to the east अदन्त *adant*. ओसर *osar*, or to the west कलोर *kalor*, is a heifer ready for the bull. In North-East Tirhut she is गौर *gaur*, in Patna फेटाइन *phetāin*, and in South Bhagalpur अँकरिया *ankariya*. In South-East Tirhut थैर *thair* is a two-year old heifer. Full-grown cattle are तैयार *taiyār*. In calculating roughly the age of pack-bullocks, the word तौल *taul*, or in Gaya पूर *pūr*, is used. Thus एक तौल *ek taul* or एक साल के तौल *ek sāl ke taul*, one year full-grown; दू तौल *du taul*, two years full-grown; and so on, the counting commencing from

* Cf. the proverb जाही तें किछ पावरे सहिए कहुइ बेन; लात खात चुहुकार तें सहत दुधारि धेन *jāhi teñ kichhu pāvai, sahiai karui bain; lāt khāt chuchukār teñ sahat dudhāri dhen*,—from whomsoever you expect to receive benefits, you must bear abusive words; even while being kicked by a milch-cow, a man will endure its actions and pat it.

the time when the bullock has eight teeth, viz. when he is four years or more old. A calf with six teeth is called **छदाँत** *chhadānt*. It is also called **छकड़** *chhakkar*, **छकड़ा** *chhakra* (male), or **छकड़ी** *chhakri* (female). Such calves are not appreciated, as in the proverb **सुदल बरन्दा छकड़ी** *mul barda chhakri*,—as soon as a bullock is dead (it is abused and called) a *chhakri*. A calf with seven teeth is **सतन्दर** *satdar* or **सधधर** *saddhar* to the west, and **सत्तर** *sattar* elsewhere south of the Ganges, except South Bhagalpur, where it is **सतत्तर** *satattar*. In West Tirhut it is **सतन्दन्ता** *satdanta*. A calf with eight teeth is **पूरा** *pūra*, i.e. full-grown, or **अधैल** *adhail*.

1119. Coaxing a cow that has lost its calf to eat grain is called **तोरिया** *toriya*, or in South-East Tirhut **घसन्तुरिया** *ghasturiya*. In South Bhagalpur it is called **तोरियान** *toriyān*. The same words are used for reconciling a cow or a buffalo to its newly-born calf by smearing the latter with sugar. A kind of hair string used for tickling a cow with a similar object is **सेल्ल** *selh* or **सेल्ली** *selhi*; and to do this is **दाँवल** *dānwal* in the north-west and **सेल्लल** *selhal* in South-West Tirhut. Sometimes the skin of the calf stuffed with hay is put before a cow which has lost its calf, especially at milking time. Salt is sprinkled on it and the cow licks it and lets her milk flow. The stuffed calf is called **लागवान** *lagāwan* north of the Ganges. In South-West Shahabad it is called **खलितड़ी** *khalitari*, in the rest of the district **मौर** *maur*, in Patna **करन्ची** *karchi*, and in Gaya **करन्नी मूरी** *karti mūri*. The kind of food given to cows when they calve is **पखेव** *pakheo* to the west and in Patna; also **पखेवा** *pakhewa* in South Munger. In North-West Tirhut it is **चोहाट** *chohāt* or **चुहाड़** *chuhār*, and in North-East Tirhut **चोहैर** *chohair*. In South-East Tirhut it is **महेला** *mahela*, and generally **मसाला** *masāla*. In Gaya it is **पुसन्टे** *pustai*.

CHAPTER VI.—BUFFALOES.

1120. A male buffalo is **भैंसा** *bhainsa*, also **महिषा** *mahisa* in East Tirhut. A female buffalo is **भैंस** *bhains* or **भैंसी** *bhainsi*; also **भई** *bhāi* north of the Ganges, and **महिष** *mahis* or **महिषी** *mahisi* in East Tirhut. A buffalo calf is **पड़न्हु** *parru* or **कड़न्हु** *karru*. A male buffalo calf is **पाड़ा** *pāra* or **काड़ा** *kāra*, and a female one **पाड़ी** *pāri* or **काड़ी** *kāri*. A well-known proverb is **खेत महिषी चर, पड़न्हुचिँ मार** *khet mahisi char, parruhiñ mār*,—buffaloes are grazing in the fields, beat the calves, i.e., in a fight the smaller men get caught, and the richer and more powerful real

culprits get off. In Patna and the south-west लोचर *lochār* is a two-year old buffalo. In Gaya it is टेहान *tehān*. A buffalo with two teeth, *i.e.* three years old, is पस *pas*.

CHAPTER VII.—GOATS.

1121. A goat is चेर *chher* or बकर *bakkar*. A he-goat kept for breeding is generally बोका *boka*. General names for all male goats are बकरा *bakra*, खस्सी *khassi*, or खँस्सी *khañssi*. Other terms are चागर *chhāgar* or बोकड़ा *bokra* (North-East Tirhut), बोनू *botu* (Patna) or बोनो *boto* (South-East Bihār), बीयड़ *biyar* (South-West Shahabad), and बिषहन *biahan* (rest of that district). A she-goat is बकरी *bakri* or हेरी *chheri*, also हगरी *chhagri* to the east. A castrated goat is specially खस्सी *khassi* or खँस्सी *khañssi* in Tirhut and south of the Ganges. North of the Ganges the general name is चेरचा *chherua*.

1122. A kid is पठरू *pathru*. A male kid is पाठा *pātha* or मेमना *memna*, and a female पाठी *pāthi*, पठिया *pathiya*, or मेमनी *memni*. In South Munger it is sometimes called बकरू *bakru*. A goat kept for sacrifice is called south of the Ganges पठरू *pathru*, but when kept for other sacrifices it is called खस्सी *khassi*.

CHAPTER VIII.—SHEEP.

1123. A sheep is भँड़ *bheñr*. A ram is भँड़ा *bheñra* or (in South Bhagalpur) भँड़ो *bheñro*, and a ewe भँड़ी *bheñri*. A lamb is भँड़िक बच्चा *bheñrik bachcha*, also पठरू *pathru* and बकरू *bakru* in Tirhut. मेमना *memna* is also used in South-East Tirhut.

1124. A flock of sheep or goats is झुण्ड *jhund* or झूँड़ *jhūnr*; also जेड़ *jer* in East Tirhut, हेड़ *her* in West Tirhut, and जेज *jel* in South Tirhut. A flock of about twenty is लँहड़ *leñhar*, and of about one hundred बाग *bāg*. गहँड़ *gahenr* is a still larger flock of four or five बाग *bāg*. In South Bhagalpur खरुहो *kharuho*, and in South Munger सहेर *saher*, mean a flock of sheep.

CHAPTER IX.—PIGS.

1125. The general term is सुगर *sugar* or सूअर *sūar*, also डोका *dhoka* in North-East Tirhut. Musalmān villagers call them euphemistically

बद कौम *bad kaum*, or in North Tirhut and Patna बद खोम *bad khom* (i.e., 'low caste'). Other similar names are हराम *harām* in Gaya, and बद मोहरी *bad mohri*. A young pig is पाहुर *pāhur* to the east, also (male) डहुरा *dahra* north of the Ganges and in Gaya, टहुरा *tahra* in Shahabad, छौना *chhauna* in Patna and the west, and छावा *chhāwa* in Gaya. Female names are डहरी *dahri* (also in Gaya) or छाई *chhāi* north of the Ganges, and कुम्भी *kumbhi* in Gaya. A full-grown boar is पट्टा *pattha* or पटुरा *pathra* in North-East Tirhut, and a full-grown sow is सोमनी *sonni* in the same place. A pigsty is खोभार *khobhār*, or to the west खोभारि *khobhāri*. In South-West Shahabad it is also खोबार *khobār*. In South-East Bihar it is खभार *khabhār*, and in Patna and Gaya it is बखोर *bakhor*.

CHAPTER X.—HORSES, MULES, AND ASSES.

1126. A horse is घोड़ा or घोरा *ghora*, and a mare घोड़ी or घोरी *ghori*. A common term for both is घोड़ or घोर *ghor*. South of the Ganges and in Sāran another word for a horse or mare is चरवा *charwa*. A pony is टटू *tattu*, and a pony mare टटुआनी *tatuāni*, and also in Patna and Gaya मद्यान *madyān*. A foal is बहेड़ा *bachhera*, and a filly बहेड़ी *bachheri*.

1127. To own a horse is a great piece of display according to Bihar ideas, as in the proverb डेढ़ गोट घोड़ी, नौ गोट फौज *deh got ghori, nau got phauj* (spoken of one who makes display when he cannot afford it),—the owner of one and a half (i.e. two wretched) mares goes about (like a lord) with nine servants.

1128. An ass is गदगा *gadha*, a she-ass is गदही *gadhi*, and an ass's foal गदगा के बच्चा *gadha ke bachcha*, or (in East Bihar and Shahabad) छौनी *chhauni*. An ass-driver is गदगाड़ी *gadhaūri*. A mule is खचड़ *khachchar*.

CHAPTER XI.—ELEPHANTS.

1129. An elephant is हाथी *hāthi*, a male elephant is हात्ता *hattha*, and a she-elephant हाथिनी *hathini*, हाथनी *hathni*, or (in East Tirhut) मेदनी *medni*, and in South-West Tirhut जोही *jorhi*. A male elephant with small tusks is मकुना *makuna*. One with large tusks is पट्टा *pattha*.

1130. Elephants are tied up with a front foot-chain, which is *बेड़ी beri* or *पैकर paikar*, and also in South-East Tirhut *चनुषा chhanua*. Its hind legs are chained with chains called *दग्गी daggi* or *नङ्गर nangar*, and also with a wooden hobble, called *कठबन्धन kathbandhan*.

CHAPTER XII.—CAMELS.

1131. A camel is *ऊंट ūnt*, also among Musalmāns *शतुर shutur*. Its young is called *बोता bota* in North-East Tirhut. Its nose-ring is *नकेल nakel*. *कठरा kathra* or *काठी kāthi* is its wooden saddle, also called *पलान palān* in North-East Tirhut; and *गदेल गदेल gadela* or *गद्दी gaddi* is the pad.

CHAPTER XIII.—STRAYING OF CATTLE.

1132. To stray is generally *हेरा जाएब hera jāēb*; also in Sāran *भूला जाएब bhūla jāēl*. Other terms are *अनेर aner* (or *अनेरवा anerwa*) *जाएब jāēb* in North-East Tirhut, *बहकल bahkal* or *भौरियाएल bhouriyāēl* in Shahabad, and *बहत जाएब bahat jāēb* in Patna and Gaya. *बथान bathān*, and also in North-East Tirhut *गोआस goās*, is a cattle enclosure. Other words are *घेरा ghera*, *डाठ dhāth*, and *डाठा dhātha*. *लम्ब लम्ब lambhab*, or *लाम्ब लाम्ब lāmhab*, is to drive cattle into another's field to graze on the crops.

CHAPTER XIV.—COLOURS OF CATTLE.

1133. These are—

White.—This is *चरक charak* or *चरका charka*, with a variant *चरको charko* in South Bhagalpur. In Gaya it is *रुपाधी rūpādhai*, and elsewhere also *रूपधर rūpdhar* or *रूपधौर rūpdhaur*. Another word is *चमुरा chamura* in North-West Tirhut.

1134. *Grey of various shades*.—*धवर dhavar*, *धौर dhaur*, or in Shahabad *धावर dhāvar*, is a light grey. *सोकन sokaṅ* is a dark grey, *कैल kail* or *कैला kaila* is a yellowish grey or cream-colour, and *सिसेबा sileba* or *सिसेवे silebe*, reddish grey. *सँवर sāṅvar* or *सौर saunra* is a black grey. *कसौटी kasauti* and *काच kachh* are shades of grey.

1135. *Red*.—A reddish cow is गोल *gol*, गोला *gola*, or गोलग्या *gohwa*. A dark red one is लाल *lāl*. A cow with a red head and the rest of the body of a lighter colour is बैरिया गोल *bairiya gol*. धुरगोलो *dhurgolo* is another shade of red in South Bhagalpur. मङ्गोल *mahugol* means red like the *mahua* flower (*bassia latifolia*). In Shahabad this is मङ्गार *mahuar*, and in South Munger मङ्गला *mahulakha*.

1136. *Yellow*.—This is पीर *piar* or पिरा *piara*. गडमन *gahuman* or गोडमन *gohuman* is wheat-coloured.

1137. *Black*.—This is कारी *kāri*, करिया *kariya*, करियार *kariyara*, or (South Bhagalpur) करवा *karua*.

1138. *A spotted cow* is काँस *kāns*, a brindle one बगन्धला *bagchalla* (tiger-skinned), लाल बगन्धला *lāl bagchalla* being a red brindle and सुफेद बगन्धला *sufhed bagchalla* a white brindle. करकन्धा *karkandha* is one black on the shoulders. In Shahabad this is called करिकन्धा *karikandha*. गुल्दार *guldār* is a spotted cow, and पाँच कलियान *pāñch kaliyān* a piebald one, or more properly one with white stockings and a white blaze on the forehead.

CHAPTER XV.—HIDES.

1139. These are चमड़ा *chamra*, खाल *khāl*, or चरसा *charsa*. गौखा *gaukha* is raw cow's leather. It is also called गोटेटा *gotta* north of the Ganges. भैंसीटा *bhainsanta* or (in South Bhagalpur) भैंसीठा *bhainsautha* is that of buffaloes. चाम *chām* is tanned cow hide. Sheep skins are खलन्ही *khalni*. A bullock's hide cut in two halves is आधा फारी *ādha phāri* or (North-East Tirhut) फाँकी *phānki*. The hides of cattle which have died a natural death are मुरदारी *murdāri* or मुरदार *murdār*, and those of killed cattle हलाली *halāli*. साबर *sābar* is tanned deer skin. A depôt for hides is चरसा के गोदाम *charsa ke godām*. In South Munger चरसा *charsa* is a cess paid by tanners to the landlord.

CHAPTER XVI.—CATTLE SLAUGHTER.

1140. A slaughter-house is लोकाना *lokāna* in Champāran, मनहर *manhar* in South-East Tirhut and Shahabad, and किलखाना *kilkhāna* in South-West Tirhut.

1141. Another name in Shahabad is गुरन्दवान *gurdawān*, and in Patna खूंट *khūnt*. Flaying and cleaning is कमीना *kamīna* or कामाना *kamāna*. A butcher is कसार *kasāi*, but a goat-butcher is बकरकसाब *bakar kasāb*, and a चिक *chik** or चीक *chik* kills both goats and sheep. The large knife used by them is बोगन्दा *bogda*, and also north of the Ganges दबिया *dabiya*. The block is टेहा *theha*, कुन्दा *kunda*, or कुन्दी *kundi*. In South-West Shahabad it is खोड़ *khōr*, and in South Bhagalpur it is परकठो *parkattho*. The string used for hanging up the animal to be flayed is लोकाना *lokāna*.

1142. A cultivator has many terms of abuse for his cattle. A favourite one is जाह कसैया खूंट *jāh kasaiya khūnta*,—may you go to the butcher, or to the sacrificial stake.

CHAPTER XVII.—FEEDING CATTLE.

1143. To chew the cud is पगुरी (or पागुर) करब *paguri* (or *pāgur*) *karab* north of the Ganges and in Shahabad. South of the Ganges generally it is पघुराप्रब *paghurāḅ* or पघुरी करब *paghuri karab*. Local names are पाज करब *pāj karab* in Tirhut, कोरी करब *kori karab* or कौरी करब *kauri karab* in Patna and Gaya, and गलठै करब *galthai karab* in South Bhagalpur.

1144. Cattle fodder, consisting of the stems of the जनेरा *janera* (*Holcus sorghum*) and similar green stuff, is cut with a chopper (see §§ 86 and ff.), and is known as कुट्टी *kutti* or कुटिया *kutiya*. In South Bhagalpur it is कुट्टरी *kutri*, and in Patna कट्टा *katta*. The fodder for stall-fed cattle is गवत *gawat* north of the Ganges. Other names are लेहना *lehna*—current in Shahabad, गौत *gaut* in Gaya, and गौतन्हा *gautha* in Patna. A general word for fodder is चारा *chāra*, or in North-East Tirhut चरौ *chari*. गजन्तौटी *gajrauti* or (in Gaya) गजन्तौटा

* It is unlucky to touch money received from these men on an inauspicious day. Hence the proverb :—

बिप्र दहलया, चीक धन, ओ बेटिन के बाढ़ ।
प्रहू से धन न घटे, तो करौ बहन से राड़ ॥

Bipra tahalua, chik dhan, o betin ke bārḥ.

Ehu se dhan na gate, to kari baran serār.

—If you cannot get rid of your wealth by having a Brāhman servant, keeping possession of money received from a butcher, or from excess of daughters, you will do it by fighting with bigger men.

gajrauta are stalks and leaves of the carrot (गाजर *gājar*) given to cattle. The chopped up sugar-cane tops (गेंड़ *genr*) given to cattle as fodder are called अगेंड़ *ageñr*, &c., as described in § 1012. चाँही *chānchhi* in North-East Tirhut is a cattle-food made of spring-crops cut before they are ripe and then dried. सानी *sāni* is the chaff and water on which bullocks are fed.

1145. To feed cattle is सानी पानी करब (or देब) *sāni pāni karab* (or *deb*). Another phrase current in Patna and Gaya is गौत देब *gaut deb*. A load of fodder is बोझा *bojha*, and also मोट *mot* in Patna, Gaya, and Shahabad. Chaff is भूसा *bhūsa*, with variants भूसा *bhūnsa* (in Patna and Gaya) and भुसा *bhussa*. The net full of chaff is जाला *jalla* or जाला *jāla* generally. In Shahabad and South Munger it is जलखर *jalkhar*, in South-West Shahabad जोरा *jora*, and in Patna कपाड़ *kapāi*. The refuse grass, &c., which cattle leave behind is लथेर *lather* to the west, निघास *nighās* to the north-east, and गोथार in Patna, Gaya, and the south-east. Local names are खधेल *khadhel* in Shahabad and गोरन्यारो *gorthāro* in South Bhagalpur.

1146. A beast that eats little is निखोराह *nikhorāh* or निखुराह *nikhurāh*, also चिकनिया *chikaniya* or अलग्जिया *alpajiya* in South-East Tirhut and गवतन्चोर *gawatchor* in South-West Tirhut. In Patna and Gaya it is optionally नक्सोंध *naksōndh*, in South Munger चिकनकौर *chikankaur*, and in South Bhagalpur चिकनजिब्धो *chikanjibho*.

CHAPTER XVIII.—PASTURAGE.

1147. Lands set apart for pasture are generally simply परन्ती *parti*. Special names are, however, रखात *rakhāt* north of the Ganges and रखांत *rakhānt* (South Munger). Other names are चिरागाह *chirāgāh* in Sāran, Patna, and South Munger, चरांत *charānt* or बाध *bādhi* in Gaya, and अरार *arār* Shahabad. A cattle-yard is बथान *bathān* or बथानी *bathāni*. The field in which cows are fed is in South-West Shahabad चराह *charāi*, in the rest of that district उबेर *uber*, and in South Munger उबेरा *ubera*. In Gaya it is बाध *bādhi*, in Patna बहरन्सी *baharsi*, and in South Bhagalpur बहियार *bahiyār* or आर *ār*. Cattle left to graze without watch are अनेरिया *aneriya* to the west, अनेरा *anera* in West Tirhut, छुठ्ठा *chhutha* in Gaya, उदङ्गर *udangar* in Patna, उज्जा *ujja* in South Munger, and उज्जरा *ujra* in South Bhagalpur.

CHAPTER XIX.—FENCES.

1148. A fence to keep cattle out of fields is घेरान *gherān* or घेरानी *gherāni* to the north-west. In Tirhut it is बारी *bāri* or बेड़ *berh*. South of the Ganges it is घोरान *ghorān*. Local names are घेरा *ghera* in Tirhut and चापा *chhāpa* in South Munger. In Champāran हिरांत *hirānt* is a hedge of brambles not fixed in the ground.

CHAPTER XX.—GRAZING-FEES.

1149. These are of two kinds:—

- (1) Those paid to the owner of the land.
- (2) Those paid to the herdsman.

1150. A cowherd is called गार *gār*, गोशार *goār*, अशीर *ahār*, चरवाह *charwāh* or चरवाहा *charwāha*, and गोरखिया *gorkhiya*. A tender of cows is in North-East Tirhut गैवाह *gaiwāh*. A shepherd is गड़री *gareñri* or भँड़र *bheñrikar*. South of the Ganges the latter also takes the form भँड़हार *bheñrikār* or भँड़ार *bheñrikāra*. A local name is भँड़धुरै *bheñrdhurai* in South Bhagalpur.

1151. (1) The fees paid to the owner of the land are known as खरचरी *kharchari* or खरचराह *kharcharāi* north of the Ganges and in Gaya. The latter also is used in Gaya. In Shahabad the term is बरदिदा *baridiya*. In Tirhut, Patna, and the east are noted कास चराह *kās charāi*, देना *dena*, भँसौधा *bhainsoudha*, and बरदाना *bardāna*. In the south-east the word is दैना *daina*. In many places these fees are only paid for buffaloes, and not for other cattle.

1152. (2) Those paid to the herdsman are चरवाही *charwāhi* or चराह *charāi*. See also § 1205.

CHAPTER XXI.—COWHOUSES AND ENCLOSURES FOR CATTLE, CATTLE-OWNERS, &c.

1153. A cowhouse is गौशार *gausār* or गौशाला *gausāla*. To the east it is गोहाल *gohāl*. Local names are गैघरा *gaighara* in North-East Tirhut, दरखोल *darkhol* in South-West Shahabad, and दोगाह *dogāh* in Patna and Gaya. सार *sār* is also used to the west. बरघरा *barghara*, or in Gaya बहर्घरा *baharghara*, is a cattle-shed. In

Champāran a breeding-shed for cattle is called घारी *ghāri*. A place where cattle are collected is बथान *bathān*. In some places a special word is used for spots where buffaloes are collected, viz. हिरात *hirāt* in the north-west, लेंद *lenrh* in North-West Tirhut, बैठार *baithār* in East Tirhut. To collect cattle is बथनियाग्रल *bathniyāēl*. In North-West Tirhut it is लेंदियाग्रल *leñrhīyāēl*. A cattle enclosure is पाझा *pājha* in the north-west and पलानी *palāni* in Tirhut. In Shahabad it is अरार *arār*. A local name in North-East Tirhut is धडा *dhattha*, which becomes धठ *dhāth* in West Tirhut. A general word is बथान *bathān*. In Patna अरान *arān*, and in Gaya अरा *ara*, is an enclosure for cattle in the forest.

1154. To the west an owner of cattle is called मौबार *mauār*. The song sung by cowherds while herding is called बिरन्हा *birha*, or (in South Munger) महन्दा *mahrāi*. Another similar song, but sung to a different air, is चाँचर *chānchar*. लोरन्का *lorkāi* is a special cowherd's song concerning a hero called लोरिका *lorika*. In South Bhagalpur the cowherd's dance is called लोड़ियारो *loriyāro*. The man who dances is called नहुआ *natua* or नेहुआ *netua*.

1155. In Gaya चेल्हा *chelhua*, in West Tirhut चल्हा *chalha*, and in Sāran चाल्हा *chālha*, is a knife used by milkmen. The brand for branding cattle is साटी *sāti*.

CHAPTER XXII.—CATTLE-DEALERS.

1156. These are फेरन्हा *pherha* north of the Ganges, and in South Bhagalpur फेरन्बैक *pherbaik*. In South-West Shahabad they are हरिहा *hariha*, in Patna लेंहन्डिवाला *lenhriwāla*, in South Munger गेंहन्डिवाला *genhriwāla*, and elsewhere हारन्वाला *hārwāla*.

CHAPTER XXIII.—MILK AND ITS PREPARATIONS.

1157. Milk is दूध *dūdh*. Cow's milk is गय *gabya* or गोरस *goras*. To milk an animal is दूहब *dūhab* or लगग्रब *lagārb*. A cow that gives milk is लगन्हर *laghar* or लगन्वान *lagwan*, as opposed to नाठा *nātha* or अनाठा *anātha*, which is one that does not; one that milks plentifully is दुधारि *dudhāri*.*

* Cf. § 1117. Another proverb is दुधारि गय के दू लतो भला *dudhāri gāy ke du lāto bhala*,—even two kicks from a good milker are to be valued.

1158. When the milk of a cow or buffalo runs dry, the word used is *बिसुखव bisukhab*. Local words are *ढाँठ होएव thānth hoēb* (South-East Tirhut), *बिसखव biskhab* in Patna and South-East Tirhut, *चुखटाव chukhtāv* in Shahabad, and *ठमरा thamra* in the south-west of that district. The milk of a cow for six months after calving is *धेन* (or south of the Ganges *डेन*) के *दूध dhen ke dūdh*. After that it is *बकेन के दूध baken ke dūdh*.

1159. The unsophisticated Bihār villager is not ignorant of the advantage which accrues to the seller by watering the milk he sells. According to popular belief the cow acts as the milkman's confederate in this, as in the proverb *गाय गोआरें मिलाप, ठेऊनें पानि दुहाव, gāy goārēñ milāp, thehuneñ pāni duhāv*—the cow and the milkman are confederates, for (without the pail leaving his) knee, she lets him milk water into it. At the same time it is but fair to add that some translate the proverb as meaning that when a cow and the milkman are friends she will let him milk her even standing in water up to her knees. Both translations are possible.

1160. Clarified butter is *घू ghyu*. Sometimes the Hindi word *घी ghī* is used. The word is sometimes spelt *घीव ghīv*. Local names are *नेउन neun* in West Tirhut, *चिकना chikna* in Gaya, *नेनू nainu* or *लेन lain* in Shahabad, and *नेनू nenu* in the east. Fresh clarified butter is *आहीर के घू ahīr ke ghyu*, or in South Bhagalpur *गिरस्तू घू girastū ghyu*; and that stored for a time in leather vessels *कुप्पी के घू kuppī ke ghyu* or *गेल्हा के घू gelha ke ghyu*. South of the Ganges it is also called *दखिनाहा घू dakhināha ghyu*.

1161. The sediment which settles in making clarified butter is *मठियार mathiyar*, *माठ māth*, or *माठा mātha* north of the Ganges. South of it it is *लेनू lainu* in South-West Shahabad, *मठगर mathgar* in the rest of that district, *मठाहा mathāha* in Gaya, and *मठाही mathāhī* in Patna. The refuse left in boiling it down is *डाही dāhī*; also *महिया mahiya* in North-West Tirhut, and *घोर ghor* in Tirhut generally. Other names are *फाड़न phāran* and *महरन mahran* in Shahabad, and *कोरौनी korāuni*, used in the same place and in South Munger; *खँखोड़ी khankhori* in the rest of Shahabad, and *खरचनी khurchani* in Patna.

1162. Tyre or curdled milk is *दही* or *दहि dahi*. It should be noted that this word is feminine, though grammarians say it is

masculine.* Another name current in West Tirhut is सजुरं *sajur*. The old curds put in to curdle milk are जोरन *joran*. Tyre is a luxury, hence the proverb घर दही, बघरतो दही *ghar dahi, bahro dahi*,—only he who eats tyre at home gets it abroad.

1163. *Curdled milk* is जमाव दही *jamāo dahi* or सजाव दही *sajāo dahi*. Other names are सँची *sānchi* to the east, सजवा *sajwa* in North-East Tirhut, मिथुर *mithur* in South-East Tirhut, and जमुइ *jamui* in Gaya. The cream of this is called चाह्नी *chhāñhi*, a local variant being चाही *chāhi* in Patna. In South-West Shahabad it is सारही *sārhi*. When this is taken off, the remainder is called कट्टर दही *katūi dahi* or चल्ककट्टर *chhalkatui*. In Shahabad it is also called चिहुर *chhinui*, and another name north of the Ganges is चिनुही *chhinuhi*. Another variety of curds, from which the whey has been expressed or boiled, is called छेना *chhena*. It is something like the dry curds from which cheese is made in England.

1164. The thick milk given by a cow just after calving, or *beesting milk*, is फेनुस *phenus* or फेनुसा *phenusa* to the west. In Tirhut and the south-east it is खिरसा *khirsa*, and in Gaya ढाकर *dhākar* means the milk of the first milking after calving, फेनुस *phenus* being that of the second. A cow that drops her milk is कामधेनुया *kāmdhenua* or धेनुआगर *dhenuāgar* north of the Ganges, also खासर *khāsar* in East Tirhut. To allow the calf to suck the teats of a cow for an instant before milking, so as to induce the latter to let the milk flow, is फेनुआग्रल *phenhāel* or पंहाग्रल *penhāel*.

1165. *Cream* is मलाई *malāi* or बलाई *balāi*, and skim-milk पसावन *pasāwan* or (in East Tirhut) च्छुआ दूध *chhanua dūdh*.

1166. *Butter* before clarification is नेउन *neün* north of the Ganges, and also नेन *nen* in North-East Tirhut. South of the Ganges it is लैनु *lainu* to the west, चिकना *chikna* and मक्खन *makkhan* in Patna and Gaya, and नेनु *nenu* there and in the south-east. Butter-milk is मट्टा *mattha*, माठा *mātha*, or घोर *ghor*. In Gaya and the south-west it is also चाँह *chhāñchh*. A well-known proverb about butter-milk is दूधक जरँ मट्टा फूकि पीने *dūdhak jarē mattha phūki pibe*,—through having been scalded by (hot) milk, he blows on the butter-milk before he drinks it, i.e., a burnt child dreads the fire.

1167. खोआ *khoā* is milk boiled down till it is thick.

* *E.g.*, in Manbodh's Haribans, VII, 48, एकसो दहि नहिँ लेल आबलाहि, *ekao dahi nahiñ lel adhalāhi*,—they did not take a single bad curd.

CHAPTER XXIV.—CATTLE DISEASES.

1168. Medicines are administered through a bamboo tube called *ढरन्का dharka* or *काँड़ी kānri*.

1169. The identification of the following diseases is in many cases very doubtful. The list is given rather in the hope that it may form the basis of a future identification by competent experts. Probably many of the names given as representing different diseases are merely different local names of one and the same disease.

1170. *Farcy*.—This is *अगिया agiya* or *अगिनबाय aginbāy*.

1171. *Diseases of the stomach*.—*जोंकी jonki* is inflammation caused by small leeches in the stomach and liver. In West Tirhut it is *जोकटी jokti*. *पेटचखी petchali*, or (in Tirhut) *पेटौक petauk*, is diarrhoea; *पोकब pokab*, or in North Tirhut *कौड़ी chhūri*, is purging. *पिलन्ही pīlhi* is said to be a swelling of the liver. Perhaps it is disease of the spleen.

1172. *Foot and mouth disease*.—This is *खोरन्हा khorha* in the north-west and in West Tirhut, *अहन्वाह ahwāh* also in Champāran and North-West Tirhut, *खंगन्हा khangāha* in East Tirhut, *खोंगन्हा khongha* in West Tirhut, *भजन्हा bhajha* in South-East Tirhut, *आभा ābha* in Tirhut generally, and (optionally) *खुरन्हा khurha* in Patna and Gaya.

1173. *Diseases of the throat and mouth*.—*आँती बढब ānti barhab*, or *आँती चढ़ जाप्रब ānti charh jāḅb*, is swelling of the uvula. *कण्ठार kanthār* (Gaya and the north-west), *भिरुखी bhirukhi* (Tirhut), *कण्ठा रोग kantha rog* (Gaya and Tirhut), *ढरन्का dharka* (Patna), is a disease of the throat and chest, which swell and prevent the animal swallowing. *ढाँसी dhānsi* (north of the Ganges) is cough. *बेंगा bengā* is inflammation of the vessels of the tongue followed by dysentery. *थुकन्हा thukha* (Patna and the south-east) is described as a disease in which saliva flows from the mouth. *सुखन्हामी sukhbhāmi* (north-west and Gaya), *छेँड़ी chheṅṅri* (Tirhut), *ढँतनर ḍantnar* (South-East Tirhut), *हनुखा hanua* (South-East Tirhut and Patna), *सुकरन्वाँत sukarwānt* (Patna, Gaya, and Shahabad), *दन्त लहर dant lahar* (South Bhagalpur), are described as diseases of the tongue. *जिब्वी jibbhi* (West Biḅar) or *जिभन्सटा jibhsatta* is lampus. *भुण्डी bhundi* (Patna) is described as a throat disease. *कण्ठा सारु kantha sārū* (South-East Biḅar), or in Gaya *नादी कन्वा nādi kanva*, is a disease in which sores form in the throat; so also in the same tract is *सोना*

होला sona hola. चोर मटका *chor malka* (South-East Bihar) is a disease of the mouth which prevents the animal eating. मुँह-पसिया *muñhpasija* is diarrhoea with watering at the mouth. In Gaya घरघरवा *ghargharwa* is a disease accompanied by rattling in the throat. घोंघुलवा *ghonghphulwa* in Gaya, and घेघुवा *gheghua* in Gaya and Shahabad, is a kind of goitre.

1174. Diseases of the feet.—Foot-rot is भनकवाह *jhanakwāh* (North-West Bihar and Shahabad) and भनक *jhanak* in Tirhut. In Patna it is भनकवाता *jhanakbāta*, and in South-West Shahabad भनका *jhanka*. बाता *bāta* is a swelling of the knee-joint. When a bullock becomes lame through overloading, the phrase used is भर जाप्रब *bhar jāēb*, सरक जाप्रब *sarak jāēb*, or उखर जाप्रब *ukhar jāēb*, or in South-East Tirhut खज्जा *khanja*. चरैया *charaiya* in the south-east is too large hoofs. खाँग *khāng* is an insect bred in the feet, which is supposed to devour the whole body. An animal affected with it is खाँगल *khāngal*.

1175. Rinderpest.—This is चेचक *chechak* everywhere. Other names are गोटी के निकसारी *goti ke niksāri* and महमाया *mahmāya*, both generally, and बरका बेमारी *barka bemāri* in Champāran, गोसाउन *gosāūn* in North-East Tirhut, अन्तर कटवा *antar katwa* and जगदम्मा *jagdamma* in Gaya.

1176. Windy colic.—This is फुलवात *phulbāt*, पेट-फुली *pet phulli* in Tirhut and Shahabad. In Patna it is बिन्धा *bindha*. A similar disease, accompanied by difficulty of breathing, is फुलबघा *phulbagha* in Gaya and Shahabad.

1177. Staggers.—These are मिरगी *mirgi* generally; other names are घुरनी *ghurni* (Patna and the south-east), घुमरी *ghumri* in South-West Shahabad, and हतेघरवा *hategharwa* in the rest of that district. Perhaps टुनकी *tunki* in the South East, which is described as a sudden death of cattle, is a variety of staggers.

1178. Worm (or filaria) in the eye.—This is चाँदनी *chāndni* in Gaya, and माड़ा *māra* or माड़ा फुली *māra phulli* in Shahabad.

1179. Tumours.—These are जहरवाह *jaharbād*, with a variant जहरवात *jaharbāt* in Gaya and South-West Shahabad. Another name in Shahabad is पिरकी *pirki*.

1180. Fevers.—अहेया *arhaiya* or अहेया *arheya* is a fever lasting two and a half days. In Tirhut it is called जरखोर *jarkhor*.

1181. *Pneumonia* (?).—A disease attended with panting is called हॉफ *hāmph* in the north-west and in West Tirhut. In South-East Tirhut it is हफन्नी *haphni*, and in North-East Tirhut बान *bāt*.

1182. कौड़पक्का *konypakka* (South Bhagalpur) is a disease in which the liver gets abscesses. खर्रा *kharra* is a kind of mange. It generally attacks young cattle.

CHAPTER XXV.—CATTLE-FODDER.

1183. The following grasses and other plants are used for cattle-fodder. Their botanical names have not been in the majority of cases identified:—

अंकटा *ankta*,—see अंकरी *ankri*.

अंकरी or अंकड़ी *ankri* (west), भेखरी *bhekhri* (north-west and Gaya), भिलोर *bhilor* (north-west), अंकटा *ankta* (Patna, Gaya, and south-east); also अटका *atka* (South Bhagalpur), *viciu sativa*.

अटका *atka*,—see अंकरी *ankri*.

अँठली *anthuli* (Gaya), अँठिल *ānthil* (South-West Shahabad and Gaya).

अनजान *anjān*, (Patna, Gaya, and Shahabad).

अमता *amta* (West Tirhut).

अमरोरा *amrora* (East Tirhut, Gaya, and Champāran.)

अरैया *araiya* (generally).

अँठिल *ānthil*,—see अँठली *anthuli*.

उनटा चिरचिरी *unta chirchiri* (East Tirhut and Gaya).

ओरी टीनी *ori tini* (Patna and Gaya).

औंकर *aunkar* (Shahabad and Gaya).

कजला *kajla* (Champāran and North-East Tirhut) or कजरी *kajri* (Shahabad).

कतरा *katra* (Sāran and Tirhut).

कनवा *kanwa*, कन्ना *kanna*,—see केना *kena*.

करन्नी *karmi*,—see करेम *karem*.

करार *karār* (Shahabad and South Munger).

करेम *karem* (South-West Shahabad), करग्मी *karmi* or करग्मी खत *karmi lat* elsewhere, a creeping-plant with a small white flower which grows in marshes (*Convolvulus repens*).

काना *kāna*,—see केना *kena*.

कुकरौंघा *kukraundha* (north).

कुकुषा *kukusa* (South-West Shahabad).

केना *kena* (west and Gaya) or काना *kāna* (Tirhut, Patna, and South Munger), also कग्वा *kanva* (Gaya) and कग्ना *kanna* (South Bhagalpur and Gaya), which grows in Indian corn.

कोदिला *korhila* (Champāran and North Tirhut).

कौशारा *kauāra* (East Tirhut).

खग्न्डा *khagra* (Shahabad).

खुखग्सा *khukhsa* (general).

खोभी *khobhi*, (South-East Tirhut, Gaya, and Champāran).

गङ्गनी *gan̄ni* (north-west).

गङ्गहर *ganrhar* (Shahabad, Gaya, and South Munger), गङ्गियार *gariyār* (west), गङ्गेर *ganrer* (Gaya), गङ्गर *gānvar* (Patna), गङ्गार *garār* (south-east), गङ्गहर्खा *garharua* or गङ्गेरी *ganreri* (north).

गङ्गहर्खा *garharua*, गङ्गार *garār*, गङ्गियार *gariyār*, गङ्गेर *ganrer*, गङ्गेरी *ganreri*,—see गङ्गहर *ganrhar*.

गदग्न्डोखा *gadpanroa*, गदग्न्डोडा *gadpirora*, गदग्न्ना *gadpurna*,—see गदग्न्ना *gadhpurna*.

गदग्न्ना *gadhpurna* (West Tirhut and Champāran), गदग्न्ना *gadpurna* (Shahabad), गदग्न्डोखा *gadpanroa* (Patna and Gaya), गदग्न्डोडा *gadpirora* (South Munger), गदग्न्वो *ganvoo* (South Bhagalpur) (*Boerhaavia procumbens*).

गङ्गर *gānvar*,—see गङ्गहर *ganrhar*.

गुजेरा *gunjera* (South-West Shahabad).

गोधग्न्ना *godhna* (East Tirhut).

चकोडा *chakora*,—see तिनग्न्पतिया *tinputiya*.

चरी *chari*,—see चोरॉट *chorānt*.

चारा *chāra*, branches of trees, especially of the pipar (*ficus religiosa*) or of the bar (*ficus Indica*) given as fodder to elephants.

चिकग्नी *chikni* (South-West Shahabad and Gaya).

चिक्कोर *chichhor*,—see चिक्कोरी *chichori*.

विचोरी *chichori* (Tirhut), also विचोर *chichor* (north and Gaya), विचन्होर *chichhor* (east) or विचोरो *chichoro* (South Bhagalpur and Tirhut) and लँडई *lewaï* (north-west).

चिनन्वा *chinva* (East Tirhut).

चेंच *chench* (west), गड़ौंही *garaunchhi* (Champāran and Patna), सरौंची *sāraunchi* (Gaya and South Bhagalpur), सरन्हची *sarhanchi* (Gaya and South Munger) (various species of *Achyranthus*).

चोरँट *chorānt* (Gaya and South-West Shahabad), चरी *chari* (west generally), चोरँटा *chorānta* (Patna), जुङ्गुड़ो *jurguro* (South Bhagalpur), and जुगन्डा *jugra* (South Munger).

जकेराइ *jakerāi*,—see जौकेराइ *jaukerāi*.

जिनन्वाँ *jinwān* (west) or भीरो *jhāro* (East Tirhut).

जूर *jūr* (South-West Shahabad).

जुगन्डा *jugra*, जुङ्गुड़ो *jurguro*,—see चोरँट *charānt*.

जोब *job* (Tirhut, Gaya, and west generally).

जौ केराइ *jau kerāi* (generally); जकेराइ *jakerāi* (south-east).

See § 959.

भरुआ *gharua*,—see झार *jhār*.

झार *jhār* (Tirhut and Gaya), भरुआ *gharua* (Sāran and Patna), a kind of brushwood growing on wells, &c.

भीरो *jhāro*,—see जिनन्वाँ *jinwān*.

ठहिया *tharhiya* (Shahabad and East Tirhut).

ढाँगर *dāngar* (Patna and Champāran), a species of Indian corn which bears no cobs.

ढाभी *dābhi* (north of Ganges, Gaya, and Shahabad).

ढेहुआ *derhua* (South Tirhut).

तितन्ही *tilli* (Gaya and west), नेतारी *tetāri* (Tirhut), नेतार *tetār* (East Tirhut).

तितोइ *titoi* (Gaya and South Munger).

तिनन्पतिया *tinpati*, a (south and west) and चकोड़ा *chakora* (Gaya south-east).

नेतार *tetār*, नेतारी *tetāri*,—see तितन्ही *tilli*.

दुधिया *dudhiya*, a kind of wort. It is very poisonous.

दूब *dūb* or दूम *dūbh*, also south of the Ganges दुबही *dubbhi* (*cynodon dactylon*).

धकन्ना *dhakra* (Tirhut and Champāran).

धिमोइ *dhimoi* (Gaya and west), चिमोइ *chhimoi* (South Munger).

नरन्चा *narcha* (Gaya).

नरन्जोँक *narjonk*,—see लरन्ही *larhi*.

नरन्चा *narua*,—see पोअर *poār*.

नरै *narai*, नार *nār*, नेवारी *newāri*,—see लार *lār*.

पतन्लार *patlār* (Champāran).

पपन्ना *papra*,—see पिपन्ना *pipra*.

पसौँता *pasaunta*,—see बसौँता *basauta*.

पिपन्ना *pipra* (South-East Tirhut, Patna, Gaya, and South Munger), पपन्ना *papra* (South-West Shahabad), and पुपन्ना *pupra* (Champāran and South Bhagalpur).

पुपन्ना *pupra*,—see पिपन्ना *pipra*.

पुर्नन्वो *purnwo*,—see गधन्पुरन्ना *gadhurna*.

पोअर *poār* (south), पोरा *pōra* (West Tirhut), नरन्चा *narua* (South Bhagalpur), straw which has been trampled in the threshing-floor.

फरन्का *pharka* (South-East Tirhut)

फुटिया *phutiya* (East Tirhut).

फुलेना *phulena* (north-west), ग्राम तुलन्सी *shām tulsi* (West Tirhut) or बन तुलन्सी *ban tulsi* (East Tirhut).

फेफन्ना *phephna* (East and South Tirhut).

बन तुलन्सी *ban tulsi*,—see फुलेना *phulena*.

बन पोस्ता *ban posta* (Champāran and Gaya), wild poppy.

बन केरार *ban kerāi* (Patna, Gaya, and West).

बसौँता *basauta* (north of the Ganges), बसन्वन्ता *baswanta* (Shahabad), or (North-East Tirhut) पसौँता *pasaunta*, which grows in Indian corn.

बिसाही *bisārhi* (East Tirhut).

बेहियाँ *berhiyān*,—see बेरी *beri*.

बेल्ग्वन *belwan*, बेल्गोन्हा *belonha*, बेल्गोधन *belaudhan*,—see बेल्गोधा *belaunderha*.

बेल्गोधा *belaunderha*, which grows in rice and millet, found north of the Ganges, in Patna, and South Munger. In Gaya it is बेल्गोधन *belaudhan*, in Shahabad बेल्ग्वन *belwan*, and in Gaya and South Bhagalpur बेल्गोन्हा *belonha*.

बेरी *beri* (Gaya), बेड़ियाँ *berhiyān* (Patna).

भिलोर *bhilor*,—see अँकरी *ankri*.

भूसी *bhūsi* (north) or भोसा *bhosa* (Tirhut), chaff.

भेखरी *bhekhrī*,—see अँकरी *ankri*.

मोथा *motha* (north of Ganges, Shahabad, Gaya, and south-east) (*cyperus rotunda*).

मकई के डाँठ *makāi ke dānt* (Gaya), Indian corn stalks.

मकड़ा *makra*, a grain (north of Ganges, South-West Shahabad, and South Munger) which grows in Indian corn. See § 993.

मण्डू के नारा *mandu ke nāra*,—see मडुआटी *maruāti*.

मसी *masi* (Sāran).

मुटमुर *mutmur* (north of the Ganges), which grows in rice-fields.

मडुआटी *maruāti* (Gaya and South-West Shahabad), मण्डू के नारा *mandu ke nāra* (Gaya), *marua* straw.

मुनगा *munga*, सहज्जन *sahjan*, &c., (*hyperanthera moringa*), see यसेन *sayan* in § 1074. It is very plentiful at Gaya, hence the proverb—

मुनगा, मच्छर, मोखनार, मालज्जादी, ई चोरा सँ साहबगञ्ज की आबादी,

Munga, machchhar, mokhtār, māljādī, ī chāro señ Sāhabganj kī ābādī.

—*Munga*, mosquitoes, attorneys, and courtczans, these four make up the population of Sāhabganj (*i.e.*, outer Gaya).

मुनमुन *munmun* (north-west).

मुरका *murka* (north), found in wheat and barley.

मुरेना *murena* (west).

रटनी *ratni* (East Tirhut).

राटन *rātan*,—see राही *rāhi*.

राही *rāhi* (north of Ganges).

राही *rāhi* (Shahabad, Patna, and Gaya, and South Munger), राटन *rātan* (South Bhagalpur).

लपटा *lapta* (Gaya and west.)

लरजोंका *larjonka*,—see लरही *larhi*.

लरही *larhi* (Patna), नरजोंक *narjonk* (South Munger), लरजोंका *larjonka* (South Bhagalpur).

लार *lār* or नार *nār*, also नरै *narai* (South-West Shahabad), and नेवारी *newāri* (Patna and Gaya), untrampled straw.

लंङ्करी *lenrai* (Gaya and west) or (North Tirhut) कोड़िला *korhila*, found in rice-fields. The same as चिचोरी *chichori*.

श्याम तुलसी *shām tūsi*,—see फुलेना *phulena*.

साँरै *sāñiñ* (Gaya and Shahabad) or सामी *sāmi* (North-East Tirhut).

सामा *sāma* (Tirhut),—see § 989.

सामी *sāmi*,—see साँरै *sāñiñ*.

साँवाँ *sāñwāñ*, (Gaya, South-West Shahabad, and South Munger).

सिहोर *sihor* or सिहोड़ा *sihora* (Champāran and Tirhut)

सुधरा *suara*,—see सुरन्वरिया *surbariya*.

सुरन्वरिया *surbariya* (Patna and Gaya), सुरन्वार *surbār* (Gaya and Shahabad), सुधरा *suara* (Gaya and Shahabad), सुरन्वारी *surwāri* (north), found in millet.

सुरन्वार *surbār*, सुरन्वारी *surwāri*,—see सुरन्वरिया *surbariya*.

सेही *serhi* (South-West Shahabad).

हड़ा *hara*,—see हड्डा *hadda*.

हड्डा *hadda* (north of Ganges) or (East Tirhut) हड़ा *hara*, हाड़ा *hāra*, (Gaya and South-West Shahabad), which grows in millet (*euphorbia hirta*). Cf. also § 1075.

हथबै *hathbai* (East Tirhut).

हारौती *harauti* (South-East Tirhut).

हाड़ा *hāra*,—see हड्डा *hadda*.

DIVISION VIII.

LABOUR ADVANCES, WAGES, AND PERQUISITES.

CHAPTER I.—PAY AND ADVANCES TO LABOURERS.

1184. A labourer generally is मजूर *majūr*, also in Tirhut and the south-east जन *jan*. Another very general word is बनिहार *banihār*. In East Tirhut a कमरिया *kamariya* (*i.e.*, he who wears a blanket) means a labouring man generally. In Patna, Gaya, and South Munger he is also कमियाँ *kamiyān*. In Tirhut चाकर *chākar* is a paid servant, as opposed to बहिया *bahiya* and चरवाह *charwāh*, which mean an unpaid servant. A day-labourer is in South-East Tirhut रोजहा *rojha*; elsewhere he is मजूर *majūr* or जन *jan*, as above. A servant engaged by the year is नोकर *nokar* north of the Ganges, and also चरवाह *harwāh* (literally, a ploughman) in Tirhut. Forced labour is बेगारी *begāri*, and a forced labourer is बेगार *begār*, or in Gaya हाकिम हुकमी *hākīm hukmī*. In East Tirhut जिरतिहा *jiratiha* is a labourer who receives land rent-free and works for his master without remuneration in the agricultural season. In the north-west the पारीवाला *pārīvāla* sometimes works for his master and sometimes for himself. In Tirhut खवास *khawās* means a male house-servant, Hindu or Musalman. A proverb which alludes to him is चोरक सङ्ग चोर, पहरेक सङ्ग खवास, *chorak sang chor, paharuk sang khawās*,—with other thieves he is a thief, but in the presence of the watchman he is simply a servant.

1185. A labourer's pay is मजूरी *majūri*, or to the east अजूरा *ajūra*. When paid in kind it is बन *ban* or बनि *buni*, also बोन *boni* in North-East Tirhut. When paid daily it is also called रोज *roj* (or (in Patna, Gaya, and South Munger) रोजीना *rojīna*. In Champaran it is रोजबन्धी *rojbandhi*. Monthly wages is दरमाहा *darmāha*, also महिना *mahinna* when it is a fixed sum, and महिनवारी *mahinwāri* when it means the average income of the month. Yearly wages is सालियाना *sāliyāna* or सालीना *sālīna*. In the north-west it is also सालीना *salīna*, and in

North-East Tirhut बरखी *barkhi*. In Sāran and North-West Tirhut मनी *mani* is an allowance of grain made to a servant in lieu of pay. In South Munger it is कोराना *korāna*.

1186. Advances of pay to labourers are फ़ाजिल *phājil* or अगवड़ *agwar* in the north-west. In East Tirhut they are जनौर *janaur*, in West Tirhut अगौड़ी *agauri*, and in South-East Tirhut also अगावर *agāūr*. In Shahabad they are अगवन *agvan*, in Patna अगार *agār*, in South Munger अगौरी *agauri*, and in South Bhagalpur अगन्दौर *agaur*. In Gaya they are कमिथौटी *kamiyauti*. हरवर *harwar* in the west, and हरौरी *harauri* in South-West Shahabad and Tirhut (or in East Tirhut optionally हरौर *haraur*), is an advance of grain or money or a piece of land given to a ploughman when he is engaged. In the south-east it is हरवाही *harvāhi*, in Patna कमिअई *kamiāi*, and in Gaya कमिथौटी *kamiyauti*.

CHAPTER II.—ADVANCES TO TENANTS.

1187. Advances are generally तगावी *tagāwī* or करजा *karja*. The following special names are also used:—

1188. *Advances to buy food.*—These are खैहन *khaihan* to the west and in Patna and Gaya. In Tirhut they are called बनियौटा *baniyautā*, and when in cash करजा *karja*. In Patna and Gaya they are खरिहन *kharihan*.

1189. *Advances to buy seed.*—These are विशहन *biahan* in East Tirhut, and बीहन *bihan* in Patna and Gaya. In Shahabad they are बीया बेंगा *biya bengā* or बीया बाल *biya bāl*.

1190. *Advances for purchase of cattle and sinking wells.*—These are तगावी *tagāwī* or करजा *karja* south of the Ganges. In East Tirhut अधलावा *adhlaṅva*, and in West Tirhut अधलप्या *adhlapya*, is the advance made to a tenant for the purchase of cattle. The lender receives back the amount of the advance and half of the profit derived from the cattle.

1191. *Advances for marriage expenses.*—These are करजैन *karjain* in Patna.

1192. In Champāran दहिहकी *dahihakki* is a remission made by the landlord to a lessee. In South-East Tirhut similar terms are कुटुत्ते *chhutti* (used also in Patna and Gaya) and खतिर *khātir*. In West

Tirhut and Champaran when fallow land is given to a cultivator for a quarter rent or rentfree for the first year, the custom is called **खिल्ली** *khilhi*. So also in South-East Tirhut it is **आसा चास** *āsa chās*, and in Shahabad **खील मारी** *khil māri*. See also §§ 912 and 913.

CHAPTER III.—DUES PAID BY TENANTS.

1193. These are principally the cesses paid to the resident artisans and other non-cultivating residents in the village, who are known as **पवनी** *pawani*, **पौनी** *pauni*, or **पौनिया** *pauniya*. In East Tirhut they are **पवनी पसारी** *pawani pasāri*.

1194. The **carpenter** (**बड़न्ही** *barhi*) and **blacksmith** (**लोहार** *lohār*), who are generally the same person, get a fee from the member of a marriage procession who gets any work done by him. This is known as **बिरिन** *birin* in South Munger, and as **बियाह दानी** *biyāh dāni* in South Bhagalpur. Elsewhere it is simply **इनाम** *inām* or **बकसिस** *baksis*. His remuneration for the repairs of instruments is **कटा** *katha* in Saran, **जौरा** *jaura* in Champaran, and **पाल** *pāl* in Tirhut. In Shahabad it is **कमाद** *kamāi*, and so also in East Tirhut. In South-East Tirhut it is also **भाँवर** *bhānvar*, and in South Munger it is **कमैनी** *kamaini*. When he is paid at so much paddy per plough, it is called, according to the amount, **बोभा** *bojha* in Saran, Patna, Gaya, and the south-east, **अँटिया** *antiya* or **पाँजा** *pānja* in Champaran, and **पंजौर** *panjaur* in North-East Tirhut. Another of his perquisites received at the time of sowing is called **अजुर** *anjur* in Shahabad and **अँजुरी** *anjuri* in Gaya. He receives a further remuneration for keeping the cane-mill in order. This is **पचरावन** *pachrāvan* or **भाँवर** *bhānvar* in Shahabad, **कोल्हकर** *kolhkar* in Patna, **कोल्हकर** *kolhkar* in South Munger, and **कोल्हपचरानी** *kolhpachrāni* in South Bhagalpur. In Saran he gets two rupees for each mill, and his remuneration is called **खान** *khān*. For repairing other implements he gets in Saran **साली** *sāli*, and a similar cess in Champaran and Tirhut is known as **खरिहानी** *kharihāni*. In South Bhagalpur **भाँरी** *bhānri* is the general term used for his perquisites. In North-West Tirhut **खान** *khān*, and in North-East Tirhut **खन** *khan* or **कमाद** *kamāi* (which means wages for any work done), are the wages for making a new mill. The grain actually given is **दाली** *dāli*, and amounts to from 10 to 30 *seers*. The fee for repair is **बिगन्ही** *bighati*, and is 4 annas per bigha for मोरन्दन

morhan or first cuttings, and 2 annas per bigha for खूँदी *khūnti* or second cuttings of the cane.

1195. *The weaver's perquisite.*—This is in North-West Tirhut बानी *bāni*, and elsewhere बाना *bāna*.

1196. *The shoe-maker's (चमार *chamār*) perquisite.*—This is भँवर *bhāmwar* to the west. In Gaya and Shahabad, however, it is खरिहानी *kharihāni*. It is पाल *pāl* in Champāran and Tirhut, also कामार *kamāi* and पँजौरा *panjaura* in North-East Tirhut. In the South-East it is पँजा *pānja* or बोका *bojha*, and in Patna and Gaya मँगनी *mangni*. बियौचा *biyaua* to the west and दत्त *dat* to the east is the fee given to his wife for service as a midwife.

1197. *The sweeper's (मिहन्तर *mihtar*) perquisite.*—This also is खरिहानी *kharihāni* or कामार *kamāi* in Shahabad. In the south-east it is a sweeper's and not the shoe-maker's wife who officiates as midwife. A sweeper in the south-east is हाड़ी *hāri*, and his wife is हाड़िन *hārin*. The fee paid her for her services is दत्त *dat* or दत्त भोजनी *dat bhojni*.

1198. *The perquisites of the village accountant (पटवारी *patwāri*)* are many and various. In Patna and Gaya if the tenant's lands are नगदी *nagdi* he gets in Patna $2\frac{1}{2}$ *ser*s per bigha, and in Gaya $12\frac{1}{2}$ *ser*s per plough. This is called मँगन *māngan*, and is his recognised salary. He also gets a fee of one pice in the rupee per annum for answering a raiyat's inquiries about his rent. This is called उजताना *ujtāna*. If the land is भावली *bhāoli*, he gets in the same district, in addition to the above, नोँचा *noñcha* (also in Shahabad नोचिया *nochiya*) or "pluckings," which amount to $\frac{1}{4}$ th of a *ser* per maund. A similar fee is called बलकट *balkat* in Sāran. In Shahabad a village accountant gets in the case of नगदी *nagdi* lands a perquisite of $\frac{1}{4}$ an anna in the rupee, called टकही *takahi*. In the case of भावली *bhāuli* rents he gets $\frac{1}{2}$ a *ser* or a *ser* per maund, the first being called असेरी *aseri*, and the second सेरी *seri* or सेरही *serhi*. In the case of a general clearance of rents he gets a present of 8 annas or a rupee, called फरकतियावन *pharkatīyāvan*. In Tirhut this item is called फरकाना *pharkāna* or फरिकाणा *pharikāna*. In South Munger lands are principally नगदी *nagdi*, and the village accountant is a servant of the landlord and is paid by him, and gets nothing from the tenants. His pay is as follows. In the case of नगदी *nagdi* tenures he gets a मँगन *māngan* of 5 *ser*s per bigha. When the land is भावली *bhāoli* he gets $2\frac{1}{2}$

seers per maund, and his pay is called **दहिअक माँगन** *dahiak māngan*. He also gets a **फरन्काना** *pharkāna* of one pice per rupee in the case of a clearance of accounts. In South Bhagalpur the tenant gives the accountant a **नेग** *neg* of $3\frac{1}{2}$ *seers* per maund. In most districts he charges a pice for every rupee for which he grants a receipt. This is called generally **रसिदाना** *rasidāna* or **रसिदावन** *rasidāvan*, also **कबजाना** *kaljāna* in East Tirhut. **होली खेलाद** *holi khelāi* or **फगुआही** *phaguāhi*, **दोआत पुजार** *doāt pujāi*, and **दुरगा पुजार** *durga pujāi*, are cesses levied by the accountant on the three main *Kāyasth* festivals of the Hindu year. The above are the usual amounts of his fees, but many of them vary from village to village.

1199. *Perquisites of the weighman.*—See § 914.

1200. *The village watchman* (**गोड़ैत** *gorait*, **कोतवाल** *koivāl*, or (when a Government servant) **चौकीदार** *chaukidār*) is sometimes paid by a grant of rent-free land (**जागीर** *jāgir*), and hence he is called in South Munger **जागीरदार** *jāgirdār*. When otherwise paid, his remuneration is called generally south of the Ganges **चौकीदारी** *chaukidāri*. In the north-west it is **खरिहानी** *kharihāni*, in North-East Tirhut **गोड़ैतक मूठ** *goraitak mūth*, and in South-East Tirhut **गोड़ैती** *goraiti*. In Patna and Gaya he is sometimes paid in kind, and his fee is then called **फसिलाना** *phasilāna*, and in Gaya also **नोंचा** *noncha*.

1201. *The perquisites of the landlord.*—In addition to his rent, the following customary cesses may be noted:—**गोआम** *goām* in Patna, Gaya, and South Munger, **बन्धुवैया** *banhuvaiya* in South-West Shahabad, and **गोहार** *gohār* generally, are personal services rendered to the landlord by the tenants *en masse*. **हुकूमत** *hukumat* or **फरमादस** *pharmāis* are occasional demands of service or produce for special purposes. This in South Munger is called **मदत** *mudat*, and in South Bhagalpur **हकमैती** *hakmaiti*. His perquisite of milk from his tenants' cows is in South-West Shahabad **दुहाव** *duhāv*. Cesses paid on special occasions are generally called **सलामी** *salāmi*, but there are frequently special names. *E.g.*, when a tenant's daughter is married, the landlord gets a fee called **बियाहन्दानी** *biyāhdāni*, **सालियात** *sāliyāt*, **सदियात** *sadiyāt*, or **सदियाना** *sadiyāna*. In North-East Tirhut this is usually one rupee four annas at a girl's marriage, and ten annas at a boy's marriage, which is realised from every one except Brāhmans, Kāyasths, Rajputs, and Musalmāns. In South-West Shahabad it is **मंडवच** *mānrwach*. In Tirhut and the east **धिंगान** *dhingān* is a fee paid

on the marriage of a daughter for the second time, and भोजनी *bhojñi* is paid on the marriage for the first time of a boy or girl. The former cess is paid in cash, but the latter in kind; *e.g.* in rice, pulse, or clarified butter. For other cesses paid by cowherds, see § 1151. The help given by the tenant in ploughing the landlord's lands is हरी *harī* to the north and the west generally. To the east it is हरिहर *harihar*, हरिहरा *harihara*, and हरिहरी *harihari*. Local names are संगहा *sangāha* in North-East Tirhut, हराह *harāi* in Shahabad and South-West Tirhut, and हराही *harāhi* in Patna and Gaya. The presents given to the landlord when he visits the village are सलामी *salāmi* or (in Shahabad) नजराना *najrāna*. His fee when a house is built or sold is चौठ *chauth* generally north of the Ganges, and also in East Tirhut जर चौठ *jar chauth*. In towns in Patna and South Munger it is चौथैया *chauthaiya*, and elsewhere simply सलामी *salāmi*. He collects cesses in the nature of a ground-rent from the resident artisans and traders in the village. These are called मोतरफा *motarpha* or मोतहरफा *motharpha* generally, कोठियारी *kothiyāri* in Champāran and Tirhut generally, and बसुही *basurhi* in East Tirhut. South of the Ganges they are दुअनी *duanni*, or (to the east) अबुषाब *abuāb*. In Patna and Gaya the former name represents a cess of the following description. 15 *mans* of grain, or thereabouts (according to village custom) is assumed (when rent is paid in kind) as the produce of one *bigha*. For each *bigha* (or 15 *mans*) thus calculated of the tenant's share of the crop, the landlord takes a cess of 2 *ānas*. In the case of lands paying cash rates, the cess is levied at from 2 *ānas* to 9 piec on each *bigha* of land held by the tenant. पूर *pūr* is a fee of one rupee per loom paid by weavers. In South Munger चरसा *charsa* is a cess paid by tanners. In North-East Tirhut केयाली *keyāli* or कियाली *kiyāli* (also बरदाना *burdāna* in Patna) is (or was) a transit-duty levied on cartmen for every load of grain they took. Sometimes it was levied at every place where they halted for the night. In the same tract the same name is also used for a tax levied on grain-sellers' weights. This last is called कौड़ी *kauri* in the north-west, and मलिकार चुटकी *malikāi chutki* in South-East Tirhut. In Shahabad it is बयाह *bayāi*. In Gaya it is किराया *kirāya*, and the corn paid is माँगनी *māngñi*. In the south-east तहबजारी *tahabjāri* or तबजारी *tabjāri* is a similar tax levied on shopkeepers.

1202. Rents are generally calculated in the old *sicca* rupees of Akbar, which are converted into current coin by adding exchange rates,

called बहा माल *batta māl* and बहा कम्पनी *batta kampani*. The *batta māl* is added direct to the rent in *sicca* rupees, and denotes the exchange rate between them and the Murshidabadi coin introduced in the year 1773. In 1835 the introduction of the Company's rupee, $1\frac{1}{5}$ of which equalled $\frac{1}{5}$ of the Murshidabadi rupee, led to the imposition of a further rate of exchange, called *batta kampani*, which is calculated on and added to the rent calculated in *sicca* rupees plus the *batta māl*. Each of these rates of exchange is generally less than one anna per rupee.

1203. *Dues given for religious purposes.*—The first fruits given to Brāhmins are बिसुन पिरित *bisun pirit*, and also (north of the Ganges) बिसुन अन्स *bisun ans*. To the west they are अंगुँऊँ *anganūñ* or अंगुँआँ *anganūāñ*. On the other hand first fruits set apart for house-gods (भूमि गनेस *bhūmi ganes*) or penates are अगुँ *agaun*, or (in Shahabad) अगुँवर *agbar*, and (in Champāran) रसुसद् *rasuar*. In South Munger three small heaps (कुद्दी *kuddi*) are put aside on the threshing-floor. One is given to the Brāhmins, and is called बिसुन पिरित *bisun pirit*; the second is given to the मूसन्हर *mushar* of the village, who is known as देहुरी *dehuri*, and is called सहार *sahār*; and the third, called अगुँ *agaun*, is set apart for the house-gods, and is consumed by the cultivator himself. In South-West Shahabad a small heap of grain is put aside for the village god (दिहवार *dihwār*). This is given to the village milkman (गोशार *goār*), who performs the worship of the god, and it is called पिठार *pithār*. In South Munger बहुरैया *bahraiya*, and generally बेहुरी *behri* or बहुरिया *bahuriya* (all of which mean simply a subscription), are names for the subscription for the expenses of village worship, and दहिक्क *dahiak* is a similar cess of $1\frac{1}{2}$, and सवैया *sawaiya* of $1\frac{1}{4}$ seers per maund. The grain set aside for beggars (फकीर *phakīr*) are known as भिच्चा *bhichcha* or भौख *bhikh* amongst Hindus, and रसुली *rasūli* or फकिराना *phakirāna* amongst Musalmāns. The सिब अन्स *sib ans* is the portion set aside for religious mendicants (सन्यासी *sanyāsī*).

1204. *Miscellaneous.*—पुरौता *purānta* is the fee paid by the members of a marriage procession to any person who does any work for them. In North-West Shahabad 10 *seers* per plough are taken each by the washerman (धोबी *dhobi*) and the blacksmith (लोहार *lohār*). This is called जौर *jaura*. In the same place खरवन *kharvan* is an armful of crop given to each of the following:—the blacksmith, the carpenter (बढ़न्ही *barhī*), the barber (नौचा *nauca*), and the washerman; and the केड़ा *kera* is a smaller bundle of crop given to each of the same four.

Again पूरी *pūri* is three handfuls of crop given to the same four. In West Tirhut a similar cess is called पाल पसेरी *pāl paseri*.

1205. In Shahabad, and also in South Bhagalpur, बन *ban* is an allowance of one maund in twenty-one or twenty-five of crop given to the agricultural labourer. In South-West Shahabad the cowherd receives a certain share of the milk of the cows he grazes, which is called बारा *bāra*. In South Munger this is परौषा *paraundha*, and in South Bhagalpur परोधो *parodho*. Similarly अठवारा *athwāra* (*i.e.* paid every eighth day) in Saran, पार *pār* in North Tirhut, भँज *bhānj* in West Tirhut, and पारा *pāra* or दुहिया *duhiya* in South Tirhut, is the milk given to the milkman as a fee for milking cows. चरवाही *charwāhi* is a fee paid to the herdsman for herding. It is also चरार *charāi* in Shahabad. सलामी *salāmi* or कमरखोलाइ *kamar-kholāi* is the term applied to the presents made to or demanded by a police-officer or Government peon on entering a village, and the same terms are also applied to the presents made by the local police to the menial servants of magistrates and other high Government officials when in camp in their own district. In West Tirhut they are also called इनाम *inām*.

DIVISION IX.

LAND TENURES.

CHAPTER I.—TENURES.

1206. The descriptions contained in this division do not pretend to be legal definitions of the tenures referred to. On the contrary, they are only to be taken as giving the popular ideas (always more or less indefinite) current among the villagers as to the nature of the tenures.

Land tenures may be divided into—

- (1) Proprietary tenures.
- (2) Tenures intermediate between proprietary and cultivating ones.
- (3) Cultivating tenures.

CHAPTER II.—PROPRIETARY TENURES.

1207. (1) *Revenue-paying tenures.*—These are known everywhere as *जिम्मिदारी jimidāri*. A very large landlord is, however, called a *तालुकादार tālukādār*, and his tenure *तालुकादारी tālukādāri*. This is the popular distinction in Bihār between the two names. Both tenures can be held in common and can be divided. When, in popular phraseology, it is wished to name a tenure which cannot be held in severalty, but is owned by one heir, the other heirs being given villages or *parganas* on which to subsist, it is called a *राज rāj*. In a *जिम्मिदारी jimidāri* (or *तालुकादारी tālukādāri*) tenure the whole land is held and managed in common. The property itself is called *जिम्मिदारी jimidāri*, or *मिलकियत milkiyat* if it is small, and *तालुका tāluka* if it is large. The rents with all other profits from the estate are thrown into a common stock, and after making the deductions to be noted* further on the balance is divided among the proprietors according to a fixed law or share. The deductions are the Government revenue and other expenses. The Government revenue is generally *मालगुजारी mālgujāri* or *मसगुजारी malyujāri*, also *लाट lāt* and *रोल rol* in Tirhut and to the east, and *खजाना khajāna* in North-East Tirhut. In Patna

and Gaya it is also known as कलटरी *kalat̄ri*. The other expenses are known as गाँव खर्च *gañ̄ kharch* generally, also गाँव के खर्च *gānw ke kharch* or गवैयाँ खर्च *gawaiñyāñ kharch* in Tirhut. In South-West Tirhut they are also सालीना खर्च *sālina kharch*. In Gaya (and East Tirhut optionally) they are देही खर्च *dehi kharch*, in Patna प्रखराजात *ekhrājāt*, and in South Munger गरन्ही खर्चा *garhi kharcha*. In South Bhagalpur they are बन्धखर्चा *banh-khārcha*, which properly means embankment expenses.

1208. A landlord is ज़िम्दार *jimudār* or मालिक *mālik*; also sometimes सरकार *sarkār*. Local names are गाँव के ठाकुर *gānw ke thākur* in South-West Shahabad, and गाँववाँ *ganūñāñ* generally in that district. When the tenure is held in joint property, the shareholders are called हिस्सेदार *hissedār*, &c., see § 1214. The Government revenue is paid in by one of the body, called लमरन्दार *lamardār* in Sāran and मोखन्तार *mokhtār* in Tirhut and Patna. In Shahabad he is लम्बरन्दार *lambardār*. He is also known generally as तहसिलन्दार *tahsildār*, कारपरदाज *kārpardāj*, or मोखतियार *mokhtiyār*. In North-East Tirhut he is also known as टिपन्दार *tipdār*. The inferior proprietors are known as खुरन्दिहा मालिक *khurdiha mālik* north of Ganges, while south of the Ganges they are खुरन्दिघा मालिक *khurdiya mālik*. In Patna they are known as चुजन्वी हिस्सेदार *chujwi hissedār*.

1209. (2) *Free grants*.—These are known generally as बिरित *birīt*, and the holder as बिरितिहा *biritiha* or बिरितन्दार *biridār*. These are general terms, and amongst them may be mentioned the following:—

- (a) *Granted for religious purposes*.—These are known generally as सङ्कल्प *sankalp*, and are of different varieties, such as बरन्मोतर *barmotar*, for the worship of Brahma; विशुन प्रीत *bishun prīt* or विशुन अरन्पन *bishun arpan*, for the worship of Vishnu; सिबोतर *sibotar*, for the worship of Siva; किशन अरन्पन *kishan arpan*, for the worship of Krishna, and so on.
- (b) जागौर *jāgīr*, लाखन्राज *lākhraj* (rentfree), माफी *māphi*, मिमन्हे *minhai* (at reduced rent), or खिल्लत *khillat*. These are properly grants for warlike services. They are also (especially जागौर *jāgīr*) applied to the free grants of land for services made to the potter (कुम्हार *kumhār*), watchman (गोहेत *gorait*), and other village servants.

- (c) A grant given to the family of a man killed in the Rājā's service in open fight. This is **मरुवट** *marvat* in the west, and **मरौटी** *marauti* to the east.
- (d) A **बिरित** *birīt* may be either acquired by purchase, when it is known as **खरिदगी** *kharidgi*, or it may be given by favour, when it is called **इनाम** *inām* or **इनामत** *ināmāt*. Local names in such a case are **खैरात** *khairāt* in Shahabad, and **खुसबकत** *khusbakat* in South Bhagalpur.
- (e) **खोरिष** *khoriṣh* or **मोकरी** *mokri* (north of the Ganges), also **पालक** *pālak* (Sāran), other local names being **खोराकी** *khorāki* or **परवसन्ती** *parvastī* (South-East Tirhut) and **खानदान** *khāndān* (North-East Tirhut). This is an assignment by a rāja to a younger son or brother of a certain number of villages in the estate for subsistence for himself and his descendants for ever. On failure of descendants the grant reverts to the parent estate. This occurs in the case of a rāj which cannot be divided.

CHAPTER III.—INTERMEDIATE TENURE.

1210. The principal intermediate tenure is that known as **ठीकेदार** *thikedār*, in which the holder (**ठीकेदार** *thikedār*) contracts to hold the property at a fixed rental either for a certain term of years or until a sum of money (**जर समन** *jar saman*) advanced on usufructuary mortgage is repaid. In the former case it is also called **खुशकी ठीका** *khushki thika*, and in the latter **पतौतन** *patautan* in Shahabad, **पटौसाँ** *patauñān* in the North-West and Tirhut, and generally **सधौसा पटौसा** *sadhau patana*. A mortgage lease is **इजारा** *ijāra* or **जर पेशगी ठीका** *jar peshgi thika*. See § 1487.

1211. Among other intermediate tenures may be noticed the **पतनी** *patni* tenures, which form the subject of special laws. They may be briefly described as estates created by a landlord by separating a portion of his estate and letting it in perpetuity at a fixed rent. Subdivisions of these tenures let on the same principle are called **दरपतनी** *darpatni*, and these last are sometimes again allotted into smaller portions, called **सीपतनी** *sīpatni*. The holder of *patni* lands is called a **पतनीदार** *patnidār*.

1212. A tenure which may be either intermediate or cultivating, and which may be noticed here, is मोकररी *mokarari*, or tenure in perpetuity at a fixed rent. In some parts of the country these are also popularly known as सिकमी *sikmi* tenures, which usually mean under-tenures held by a cultivating raiyat.

1213. In Champāran सिकमी *sikmi* tenures are described as dependent proprietary taluks paying land revenue through the landlord who is responsible for it, and not into the Government Treasury direct. Concerning सिकमी *sikmi* rents in Gaya, see §§ 1225, 1226.

CHAPTER IV.—SHARES AND SHARERS.

1214. A share in a village is हिस्सा *hissa* and also (in Tirhut and the west) बखरा *bakhra*. The subdivision of a village held by a proprietary body is known as पट्टी *patti* or तखता *takhta*, also थोक *thok* north of the Ganges and फाट *phāt* in Gaya. A shareholder is हिस्सेदार *hissedār* or सरिकन्दार *sarikandār*; also बखरन्दार *bakhardār* to the west, पटिदार *patidār* in Tirhut. The proprietor of a half share is called अधिया *adhiya* north of the Ganges, and आधेआध *ādheādh* in South-West Shahabad. The inferior shareholders are called खरदिहा *khurdiha*, &c., as described in Chapter II. पट्टी *patti* is also used to mean the principal share in a village, which may contain several सिकमी *sikmi* or subordinate shares. The shares of a brotherhood are भैयाँट *bhaibānt* generally, or in Patna and South Munger भैया बाँट *bhaiya bānt*. In the west they are also भैवध *bhairwadh*. A father's share is बपन्स *bapans*, also बपन्स *baphans* in Sāran, बपौटी *bapauti* in North-East Tirhut, and जद्दी *jaddi* in West Tirhut. An elder brother's share (which according to popular belief was larger than the share of the younger brothers before the institution of the English law-courts) is जेठन्स *jethans*, also जेठन्स *jethhans* in Sāran, and in North-East Tirhut जेठौती (not जेठौटी) *jethauti*. The Government revenue is मालगुजारी *mālgujāri*, &c., as described in Chapter II. The half-yearly instalment is known as अधखर *adhkhar* or अधकर *adhkar* north of the Ganges, also as अठनिया *athaniya* or अठनी *athanni* generally. In South Bhagalpur it is अधकर *adhkar* कस्त *kist*. The distribution of the revenue over the sharers in villages held by a brotherhood is in South-West Shahabad भेर *bher*. Elsewhere a periphrasis is used, such as हिस्सा पटिदारी *hissa patilāri*.

A proprietor by purchase is खरिदार *kharidār*, and also (north of the Ganges) बैदार *baidār*.

CHAPTER V.—CULTIVATING TENURES.

1215. A cultivator is known as असामी *asāmi*, रैयत *raiya*, परजा *parja*, or कास्तकार *kāstkar*. In Patna he is also पोतेदार *potedar*. A tenant with rights of occupancy is मौखी *maurūsi* (*literally*, hereditary) or कदीमी *kadimi* (ancient), also देही *dehi* (resident) in Patna and Gaya, and जददी *jaddi* (ancestral) in Shahabad. A tenant at fixed rates is इस्तमरारी *istamrari*, but this distinction is little observed. Hardly any cultivators, and very few landlords, know the difference between a tenant at fixed rates and one with a right of occupancy. A cultivator without rights of occupancy is known as गैर मौखी *gair maurūsi*, also as पाही *pāhi* (*literally*, 'foreign' or 'non resident') in Patna and Gaya, and खरिदगी *kharidgi* (*literally*, acquiring by purchase) in Shahabad. In North-East Tirhut he is हाल उपारजित *hāl upārijit* (newly created). These names are interesting as showing what cultivators themselves consider to constitute a non-occupancy tenant.

1216. In Shahabad, especially along the south bank of the Ganges, there is a class of tenants called गुदमन्तादार *gudashtādār* or गुदस्तादार *gudastādār*. They are generally Rajpūts and Brahmins whose ancestors conquered the country, and who, while serving under the landlords, for whom they were always ready to fight, were considered entitled to a privileged position. A गुदमन्ता *gudashta* or गुदस्ता *gudasta* tenure is held at a rent fixed for ever,* and is alienable without the consent of the landlord. It is, in fact, a freehold subject to a rent charge. The holders seldom sublet, and are a body of peasant proprietors, very prosperous as compared with other tenants, and furnishing thousands of recruits to the army. Another similar tenure is known as गौरा *gora*. In this the rent is fixed for ever in a holding with specified boundaries, without reference to the quantity of land. The rent is not variable even if the land be found to be more or less than the quantity roughly estimated at the original settlement. It is alienable without consent of the landlord.

1217. In some estates there is a kind of head tenant, who acts as an intermediary between the proprietor and the cultivator. He collects the rents and receives in return some petty privileges and immunities. He is known generally as महतौ *mahton*, and in

* This point of fixed rents is denied by some landlords.

Patna and Gaya as महुतोषादा *mahtoāra*. In Saran he is also known as टिपन्दार *tipdār*, in North-East Tirhut as मोकदम *mokadam*, and in South Bhagalpur मँडर *mañrar*. Generally, however, the head tenant is called जेठरैयत *jethraiyat*, and he usually performs the above duties. The high-caste cultivators are known as असरफ *asrāph*, local names being सुरफा *surpha* in Patna, सुरफान *surphān* in Gaya, and बड़ अदमी *bar admi* north of the Ganges. In South Bhagalpur, the quarter of the village where such live is called बबुटोला *babutola*. The remission of rent for such high-class tenants is माफी *māphi* generally north of the Ganges, also कुटन्ती *khuti* or कमन्सरे *kamsare* in East Tirhut. In South-West Shahabad and Gaya and South Munger it is रेचाप्रत *reāet*, in the rest of Shahabad मरौसती *marauati*, in Patna कमी *kami*, इनाम *inām*, or इलाम *ilām*, and in South Bhagalpur माफ *māph*. The low-caste tenants are known as राड़ जाति *rār jati*, नीच *nich*, or होट लोग *chhot log*. They are also known as रजील *rajil* in South-West Shahabad, कमीना *kamīna* in the rest of that district, राड़ भोड़ *rār bhor* in South Bhagalpur, सोलकन्ह *solkanh* in Tirhut, and रैयान *raiyān* in Gaya. A proverb about them is—

काप्रथ किङ्क लेलँ देलँ, बरहमन खियौलँ ।
धान पान पनियौलँ, औ राड़ जाति लतियौलँ ॥

Kāeth kichhu leleñ deleñ, Barahman khiyauleñ.

Dhān pān paniyauleñ, au rār jati latiyauleñ.

—A Kāyasth does what you want on payment, a Brāhman on being fed, paddy and betel on being watered, but a low-caste man on being kicked.

1218. Cultivators may also be divided into resident and non-resident. The resident cultivator is छपरबन्द *chhaparband*, also डिही *dihī* in North-East Tirhut, देही *dēhī* in Patna and Gaya, and बारी बस्त *bāri bast* in the south-east. A non-resident cultivator is पाही काल *pāhī kāst* or पाही *pāhī* (foreign), a word frequently confounded with पाई *pāi* (literally, a foot; hence used to mean an under-tenant). The word पाई *pāi* has almost fallen out of use now, but it is still understood, and has led to much confusion in laws and treatises on the rent-law, rendering it possible that the rights and liabilities of the under-tenant have been transferred to the non-resident cultivator. In South Bhagalpur the non-resident cultivator is known as पैहार *paihār*. The दोहट *dohat* or दोहटा *dohṭa* cultivator differs from the पाही *pāhī* cultivator in that he keeps up two establishments and cultivates in two different villages, while the पाही *pāhī* cultivator does so only in one.

1219. Below the ordinary cultivator there is sometimes an under-tenant, who is known as सिक्मी *sikmi* or कुरथौली *kurthauli*, also as पेटावाला *petawāla* in the north-west and कोलियाँती असामी *koliaiiti asāmi* in East Tirhut. It is said that to the south-east in the case of a कुरथौली *kurthauli* tenure the rent of the under-tenant is fixed at a money rate, but is paid in grain at the market rate of the grain at the time of payment. Elsewhere the rent of under-tenures is generally paid in kind.

CHAPTER VI.—RENTS.

1220. Rent is लगान *lagān*. North of the Ganges and in South-East Bihār it is also पोता *pota*, with an optional variant पोट *pot* in South-East Tirhut; another name current north of the Ganges is मलगुजारी *malgūjāri*. Rent rates are दर *dar*, सरे *sare*, or सरह *sarah*; also दरबन्दी *darbandi* or सरहबन्दी *sarahbandi*. चुकौचा *chukaua* north of the Ganges is rent payable at a fixed rate.

1221. Rent paid in cash is known as माल *māl*, and that paid in kind as ऐन *ain*. When rents are paid in cash, the tenure is known as नगदी *nagdi*, and also in East Tirhut as खाप *khāp*. When paid in kind, it is known as मनखप *mankhap* or भावली *bhāoli*. In मनखप *mankhap* or मनठीका *manthika*, ऊषा *hunda* or मनऊषा *manhunda*, the rent is a fixed quantity of grain paid as rent, irrespective of the proportion it bears to the whole crop. This custom is current principally in Tirhut and Champāran. In Patna it is called मनौ बन्दोबस्त *mani bandobast*, and a variety in which a certain number of maunds of cleaned rice per *bigha* is taken as rent is known as चौराहा *chaurāha*. These tenures are principally adopted by landlords when letting their जिरत *jirāt* or home-farm lands. In भावली *bhāoli* a certain fixed proportion of the whole crop is taken by the landlord. This division is called बटाइ *batāi*, &c., and a full description will be found in §§ 902 and ff.

1222. A tenure which has been noted in Patna is the हस्तबूदी *hastbūdi*, derived from the Persian *hast*, 'is,' and *būd*, 'was,' and which means literally 'the-is-and-the-was tenure.' In this the rate of rent is fixed at so much per *bigha*, but rent is only charged for so much area as is actually bearing crops at the time of harvest. Thus, suppose a piece of land measuring one *bigha* is cultivated, but for some reason

(such as inundation, destruction by insects, &c.) the area of land actually under crops when ready for harvest is found to be 16 *kathas*, then the rent of four *kathas* is remitted and the rent for 16 *kathas* only is demanded. It thus closely resembles the *utbandi* tenure of Bengal. Compare § 1229.

1223. **हाल हासिली** *hāl hāsīlī* tenures also exist in Patna and Gaya. In these the cash rent is determined on the spot after inspection of the existing crops on the land. A very similar tenure is known as **बलकट** *balkat*. In this the landlord's men, accompanied by the tenant, inspect the crops when ready for harvest, and fix a cash rent by estimating roughly the quantity of produce and its value.

1224. A peculiar tenure, which is principally adopted in lands which are generally subject to inundation, is known as **जैदादी** *jaidādi*. It is also adopted where the land is extremely bad and the prospect of a crop is uncertain. The principle is that the full rent agreed upon is paid on the land in any year in which any crops whatever (however small) is grown upon it. In any year in which no crop is produced upon it, no rent is paid.

1225. The tenures* and rent system in the district of Gaya are worth noting. Four-fifths of the cultivated lands are let on the **भाबली** *bhāoli* system, as has been described in sections 902 and following. In the lands held on the **नगदी** *nagdi* system the rent conditions are somewhat peculiar. The *nagdi* tenure is of two descriptions,—**सिकमी** *sikmi* or **शिकमी** *shikmi*, and **चिकठ** *chikath* or **चकठ** *chakath*.

1226. A **शिकमी** *shikmi* tenure is described by Bābu Bhūp Sen Singh as that under which the landlord has not any power of enhancement, irrespective of the period for which the tenant might have been in possession. The money-rent is not fixed upon the land, but upon the crops actually grown, varying with the nature of the soil and the class of tenants, whether, high caste (**सुरफान** *surphān*) or low caste (**रैयान** *raiyān*), the former having a lower rate to pay than the latter. The lands generally under this tenure are the **दिवाँच** *dihāns* lands, or the best land lying on the borders of the inhabited portion of the village (see § 784), and the crop grown thereon pays a higher money rent than the same crops grown on fields

* Concerning the tenures in Gaya, I have to acknowledge my indebtedness to an admirable note prepared by Bābu Bhūp Sen Singh, Government Pleader of that district.

more distant from the village site. The same *shikmi* field also pays a rent varying with the crop. Thus if a Brahman tenant planted it with opium poppy in one year and with an ordinary spring crop next year, he would pay a higher rate of rent the first year than the second; while a low-caste tenant would have to pay for both of them a higher rent than the Brahman. Every tenant in a village has a fixed quantity of *shikmi* land partly at the higher and partly at the lower crop rate. If the tenant grows opium poppy upon a *bhāoli* and not a *shikmi* field, he pays for one harvest *bhāoli* rent, and is liable also to pay *nagdi* rent for the poppy at the rate fixed in the village for the particular class of tenants to which he belongs for poppy grown under such circumstances. According, however, to other authorities the rate of rent of these *shikmi* tenures is unalterable, but an extra rate or cess of so much per *bigha* is put on when special crops, such as opium or sugar-cane, are grown, and is taken off again when these special crops cease to be grown. Compare § 1231.

1227. The चिकठ *chikath* or चकठ *chukath* tenure is, according to Bābu Bhūp Sen Singh, a temporary settlement of waste or uncultivated but culturable lands for limited terms of years, at nominal rents, for the purpose of reclaiming them or bringing them under cultivation. This tenure is governed by the terms of the contract between the parties. If one term be not sufficient to render the lands fit for proper cultivation, the settlement is renewed from time to time till they become capable of yielding full crops. They are then settled as *bhāoli* or *shikmi* lands, according to their quality. In *chikath* lands no right of occupancy accrues by custom, and the rent is capable of enhancement on the expiry of the term of the settlement.

1228. According to Bābu Bhūp Sen Singh when a summer or जेठवा *jethua* crop is grown on *bhāoli* land, an additional rate of 20 annas per *bigha* is charged as rent, the local *bigha* equalling $2\frac{1}{4}$ Bengal *bighas*.

1229. In South-West Shahabad, when in rice lands, the tenant pays only for the land under rice, and not for any land which may be fallow, the phrase उठनी परनी *uthni parti* is used. Compare § 1222.

1230. A remission of rent on account of deficient produce is माफ *māph* north of the Ganges, and also छुटनी *chhutti* in East Tirhut. South of the Ganges it is नाबूद *nābūd*, or, when made on account of inundation, गर्की *gar ki*.

1231. Special crops, such as tobacco or poppy, on which special money rents are always assessed, are known as जबन्दी *jabdi* or जपन्ती *japti*. Cf. § 1226.

1232. Of the spontaneous produce of a village, बनकर *bankar* is the produce from forest land, wood, gums, &c. In Shahabad it is also called बन चिहोली *ban chhioli*. जलकर *jalkar* is the produce derived from lakes, streams, &c.; and फलकर *phalkar* is the produce of fruit. सिकार माही *sikār māhi* to the west is fishing rights.

1233. Fields situated in one village and included in the area of, and belonging to the proprietors of another village, are called मोतलके *motalke*, or (in Nort-bEast Tirhut) तालुका *taluka*.



DIVISION X.

THE NATIVE HOUSE.

CHAPTER I.—THE NATIVE HOUSE.

1234. A *house* is मकान *makān* or घर *ghar*. Local variants of the latter are गिरन्ही *girhī* in Gaya and Sāran, घौर *ghaur* in South-East Tirhut, घरा *ghara* in South Munger, and ग्रिही *grihī*, घरत *ghara*, or घरौ *gharo* in South Bhagalpūr. A name current in Shahabad is बखरी *bakhri*. An *enclosure containing several houses* is north of the Ganges हवेली *havelī* or हवेली *havelī*, and south of it हाना *hāta*. South of the Ganges and in Sāran हवेली *havelī* or हवेली *havelī* generally means the *female apartments*. A *palace* is धौरहर *dhaurahar* or धरहर *dharhar*, as in the proverb सूनी खड़ तर, सपनाद धरहर *sūnī khar tar sapnāi dharhar*,—he sleeps on grass and dreams of palaces. A *hut* is भोंपड़ा *ghompṛa* or भोंपड़ी *ghompri*, खोंप *khomp*, खोंपड़ा *khompṛa*, खोंपड़ी *khompri*, or पलानी *palānī*. कुटी *kūṭī* or कुट्टी *kutti* is the hut of a religious mendicant (फकीर *phakir*). Other names used north of the Ganges are मठ *math* generally, and मठिया *mathiya* to the west, अस्थल *asthal* to the north-east, and जगह *jagah* or अखरहा *akhraha* to the south-east. मरै *marai*, मँडरै *mañṛai*, or मररै *marai*, is a grass hut, and मँडो *mānro*, &c., (see section 1307) is the hut in which a marriage ceremony is conducted. A little hovel or hut is north of the Ganges गोहिया *goñiya*. South of the Ganges it is in Patna and Gaya मडुका *maraka* or कूदा *kūrha*, in Shahabad टाटी *tāṭī* or बरन्हीघर *barhaughar*, and in South Bhagalpur ढाको *dhāko* or मोरन्का *morka*. सिरन्की *sirki* is a hut or tent made of reeds, as in the proverb सिरन्की एक देलन्हि तानि, ताहि बेर मँ आग्रस पानि, सिरन्की उठाबैक रहल ना बेरा, आगू नाथ नउ पाइ पगन्हा *sirki ek delanhi tāni, tāhi ber mañ āel pāni, sirki uthābaik rahal na bera, āgu nāth na pāchhu pagha*,—he pitched his hovel and it began to rain, nor could he get an opportunity for striking it; he was (like an ass) without nose-ring or tether. A ruined house or enclosure is डीह *dih* or खँदर *khāñhar*. A hut in the forest is north of the Ganges पाक्का *pājha*,

and south of it चञ्चर घर *chanchar ghar* in Gaya, चाँचवाला घर *chānch-wāla ghar* in South Bhagalpur, टटञ्चर *tatghar* in South Munger, and मङ्गची *marhhi* in South Bhagalpur.

1235. Straw huts used by the poor are टटौघर *tataughar* north of the Ganges, and काही पोस *kāhi pos* south of it. In Shahabad they are also called दोचन्ना *dochra*, and in South Bhagalpur खरो घर *kharo ghar*. They are also very generally known as फूस के घर *phūs ke ghar* over the whole Bihār tract. A masonry house is पक्का *pakka* or पोखन्ना *pokhta*. When built of stone it is called in Shahabad चाँदनी *chāndni*. When built partly of bricks and partly of mud, it is कच्चा पक्का *kachcha pakka* or कच्चा पक्का *kancha pakka*. In Shahabad it is, however, कच्चा *kancha* or काँचा *kāncha*. A house built entirely of mud is कच्चा *kachcha*; it is also to the west खाम *khām* and to the east भीत घर *bhit ghar*.

1236. When a house has three openings, it is तिनन्दरा *tindara* or सेन्द्रा *sedra*; with twelve openings, it is बरन्दरी *bardari* or बरचन्द्ररी *barahdari*. But these terms are not much used except south of the Ganges, from and including Patna westwards. A house provided with lattices is जालन्दार *jāldār* or जालीदार *jālulār*. A house with nine apartments is in Patna and Shahabad नौरतन *nauratan*. Rooms in a native house are generally nine cubits long by five cubits wide. Such rooms are called नौपञ्चन *naupancham*. बासा *bāsa* or डेरा *dera* is a dwelling or lodging-house, and खिलवत *khilwat* a house used as a private chapel by Musalmāns.

CHAPTER II.—PARTS OF A HOUSE.

1237. *The courtyard.*—This is आँगन *āngan*, आँगनै *āngnai*, or (principally in Patna and Gaya) आँगना *angna*; also in South Munger ऐँगना *engna*. In South-East Tirhut it is also called डेरा *dera*. The space in front of a house is अगुआर *aguār* or अगुआरा *aguāra*; also अगुवास *aguwās* in Shahabad, अगुती *agutti* in Patna and Saran, and अगुआनी *aguāni* in Patna and the south-east. The space behind it is पिकुआर *pichhuār* or (generally in the oblique cases) पिकुआरा *pichhuāra*, or to the west पकुआर *pachhuār* or (generally in the oblique cases) पकुआरा *pachhuāra*. It is also पिकुत *pichhūt* to the west, पिकुती *pichhutti* in Patna and Saran, and पिकुआनी *pichhuāni* in Patna and the south-east.

1238. *The vestibule or outer entrance room.*—This is दुआर *duār* or दोआर *doār* generally. It is also दूरा *dūra* north of the Ganges,

and दुहारी *duhāri* or दुहरिया *duariya* in Patna and Gaya. Another name current in Patna and the east is देहरी *dehri*.

1239. *The inner entrance room.*—This is the room in which the men of the family sit and meet outsiders. It is called दलान *dalān*. It is also named दोगाह *dogāh* in South-West Shahabad and द्रोखा *darokha* north of the Ganges. In Patna दोगाह *dogāh* means a cattle-shed. In North-West Bihar दुमुँहाँ *dumūhān* is a somewhat similar room, but opening both to the outer world and to the inner apartments. A sitting-room generally is बैठका *baitika*.

1240. *The upper story.*—This is कोठा *kolha*, or in the south-west पटहवाँ *patahuān*.

1241. *The under-ground story.*—This is तखाना *takhāna* or तहखाना *takhāna*. Other optional names are भुंजबरा *bhunjabra* or तरहरा *tarahra* in Patna, Gaya, and the south-east.

1242. *The veranda.*—This is ओसारा *osāra* or ओसरा *osra*, with variants ओसारी *osāri* in South-West Shahabad, उसरा *usra* in Gaya, and ओसरो *osro* in South Bhagalpur. It is also called साप्रबान *sāebān*, and in Shahabad दाबा *dhāba*.

1243. *The sitting-platform.*—This is चौतरा *chautra* generally. Other optional names are चबुतरा *chabutra* and पिण्डा *piṇḍa* in Patna and the south-east, and ओटा *ota* in Patna, Gaya, and Saran.

1244. *The roof.*—The roof or ceiling is छत *chhat*. It is also छहत *chhāt* south of the Ganges, छत्ता *chhatta* in Gaya, and छहता *chhāta* in South Bhagalpur. A thatched roof is छाडनि *chhāni*, चौनी *chauni*, छाह *chhāh*, छाही *chhāhi*, or छहिया *chhanhiya* in North-West and South Bihar. It is also generally छपर *chhappar*, with an optional variant छपरै *chhapri* in the south-west. Another name current in Tirhut is चार *chār*. If it is a simple thatch without tiles, it is specially called टाट *thāt*. A thatcher is घरासी *gharāsi* or चौनिहार *chhānihār* north of the Ganges, and his work is छाडनी *chhāni*. In Patna and Gaya he is सुतिहार *sutihār*, and to the south-east गुर हरिया *ghur chhariya*.

1245. When a thatch is only a "lean-to" on one wall, it is known as एकपलिया *ekpaliya* to the west. In Tirhut it is एकवारी *ekhāri*, and to the south-west एकवारा *ekhāra*. In Patna, Gaya, and (optionally) the south-west it is एकहपरा *ekchhapra*. If it rests on both walls with a ridge pole in the middle, it is दोपलिया *dopaliya* to the west and दोचारा *dochāra* in Champāran and to the east. In Patna

it is पलानी *palāni*, and in Gaya and (optionally) South Munger दोषपरा *dochhapra*. In Shahabad another name current is दोषरा *dochra*. A roof composed of four triangular thatches meeting in a point at the top is called चौपार *chaupār*. When there are more than one thatch in a roof, each thatch is called फरका *pharka* or पल्ला *palla*. Also in the case of two thatches the front one is called north of the Ganges अगुत के ठाट *agūt ke thāt*, and the rear one पछुत के ठाट *pachhūt ke thāt*. The thatching along the ridge is कोचानी *kochāni*, or in Gaya दोगा *doga*. A small thatch put on the top of a wall to save it from rain is परन्वही *parchhatti* or उपरन्वही *uparchhatti* north of the Ganges, and south of it परन्वही *parchhatti* (with a soft *t*). Other local names are खौनी *chhauni* (North-East Tirhut), खपरी *chhapri* (Tirhut generally), and पनन्वही *panchhatti* in Patna.

1246. To rethatch a roof is ओतब *otab* or नौठ करब *nauthat karab*. The yearly repairs to a tiled roof are फेरौंटी *pheraunti* in the south-west, and elsewhere खपरा फेरब *khapra pherab*. The grass put on a roof to make it water-tight is फटकन *phatkan* in Sāran, खापन *chhāban* in Champāran, and खौनी *chhauni* or तररा *tarera* in Patna, Gaya, and the south-west. In Tirhut it is खरन *chharan*, and in the south-east खारन *chhāran*. Mud used for the same purpose is गिलावा *gilāwa*. The repairs to a tiled roof which leaks are चुअना मारब *chūana mārāb* in South-West Shahabad, डोइया *toiya* in the rest of that district, टिपकारी *tipkāri* in Gaya, and टपका मारब *tapka mārāb* in Patna.

1247. *The fireplace.*—This is चुल्हा *chūlha* generally, local variants being चुल्ह *chūlh* in Shahabad. चुल्ही *chūlhi* in South-East Tirhut, and चुल्हो *chhūlho* in South Bhagalpur. In East Tirhut चुल्ह *chūlh* is a fireplace with two orifices, and कौल्हा *kaulha* one with one. In South-West Tirhut this last is called एकौल्हा *ekaulha*. The mouth of the fireplace is called मुँह *muñh*, or sometimes दुआर *duār* south of the Ganges. In North-East Tirhut चिनन्मार *chinnmār* is the raised earth platform on which the fireplace is made, and on which food is cooked, while चौका *chauka* is the similar platform smoothed for a Hindu to eat from. थौना *thāna* to the west is a raised platform on either side of the fireplace for receiving pots for straining off rice-water. When the ground is simply smoothed for eating from, it is called ठहर *thahar*, or in East Tirhut ठाँव *thānv*. आरा or आड़ा *āra* is a cupboard in the wall at a man's height from the ground, in which cooking-pots are placed at night. बोरन्वी *borsi* is the moveable fireplace used by jewellers and by villagers (especially females) to warm themselves in winter. In North-

East Tirhut it is बोरस *boras*. घूर *ghūr* is a hole dug in the ground filled with straw and sweepings and lighted in the evening as a fire to warm oneself at. It is also called कौर or कौड़ *kaur* in the west.* The iron or earthen moveable fireplace is अँगैठी *angaiṭhi*. A similar one used by jewellers is अँगैठा *angaiṭha*. An earthen pot for holding fire is in Gaya मटपर *matpar*, and in Shahabad मँटहर *mentahar* or पौड़ा *paura*.

1248. The holes on the top of the fireplace, on which the pots are placed, are called आँची *ānchi* or अँधिया *anchiya*; also in South-West Shahabad ऐला *aila*. They are also called चुहिया *chuhīya* in East Tirhut. When there are places for four pots, it is known as a चरँधिया चूहा *charanḥīya chūha*, or in South-West Shahabad as a चरैला चूहा *charaila chulha*. The partitions between the holes are पूता *pūta*, पुत्ता *putta*, or पुत्ती *putti*. Also पुत्ती *putti* in South-East Tirhut, and पुतिया *putiya* in South Munger. The cooking-house is amongst Musalmāns बबरची खाना *babarchi khāna*; amongst Hindus it is रसोइया घर *rasoiya ghar*; also भनसा घर *bhansa ghar* in Patna and the east. In East Tirhut it is भानस घर *bhānas ghar*. The portion of the cooking-room set apart by a partition for cooking purposes only is called चुहानी *chulhāni* or चुहानी *chuhāni*. The other portion is known as मँज घर *mānjh ghar* in Saran and South-West Tirhut, as मँज घर *mānjh ghar* in Shahabad, and as खोन्ही *khonhi* in North-East Tirhut.

1249. *The door.*—A doorway is दुआर *duār*, दोआर *doār*, दुआरी *duāri*, दरवाजा *darwāja*, दरवाजा *darwāja* or (in Patna, Gaya, and the south-east) दरौजा *darauja*. A door is केवाड़ी *kewāṛi*, or in East Tirhut केवाड़ *kewār*, केवाड़ी *kewāṛi*, केवाड़ *kewāṛ*. The main doorway is सदर दरवाजा *sadar darwāja*; also निकसार *niksār* to the west, and निकास *nikās* in East Tirhut. In South-East Bihār it is समुख दरौजा *samukh darauja*. A gate is फाटक *phātak*. A side door or window with lattices is खिरकी *khirki*; also दरैची *darainchi* in Patna and Gaya. भवाँरी *bhawāri* to the west and in West Tirhut, भँभरा *bhambhra* in East Tirhut, and to the west दरौँची *daraiñchi*, is a hole pierced in a wall to give light and air. In South Munger it is भमरा *bhanra*, and in South Bhagalpur भौरा *bhoṛa*. In Patna and Gaya it is ताबदान *tābdān*. मुका *mukka* or मँका *monka*, and in Champaran अँधारी *andhāri*, is an earthen pot fixed in the wall for holding pice, &c. The leaves of the door are

* Compare the proverb घर जरेन्हि, घूर बुताव *ghar jaraiñhi ghūr butāv*,—when his house is on fire he puts out the *ghūr*, i.e. in many difficulties he grapples with the least.

पल्ला *palla*, or in Shahabad पाला *pāla*, and the strip of wood nailed on one leaf to cover the chink is बेंनी *beni* or बेंनिबाँ *beniyān*. In South Bhagalpur this latter is बेना *bena*. The cross-pieces across the leaf of the door to hold the boards composing it together are बाता *bāta* or बत्ता *batta*. There are generally four of them.

1250. The door-frame is चौकठ *chaukath*. The top bar or lintel of this is उपरौटा *uprauta* or (in Tirhut) हान *chhāt*. The bottom bar or threshold is लतमरा *latmara*, लतमरवा *latmarwa*, or लतखोरा *lutkhora*. Sometimes a second outer door-frame is added for the sake of ornament. This is called साह *sāh* or दसौही *dasaurhi*, and such a double door-frame is said to be दोहरा *dohra* or साहवाला *sāhwāla* or दसौही चौकठ *dasaurhi chaukath*. In contradistinction from this, the single doorway is सादा *sāda* or एकहरा *ekahra*. The pivot used as a hinge is चूर *chūr* or (in Patna) चूल *chūl*). In South-West Shahabad it is चूरह *chūrḥ*. A similar kind of hinge is in Gaya झनकौट *jhankant*. The wooden bar used for fastening the door is किल्ली *killi*, and also (to the extreme west) आगर *āgar*, आगल *āgal*, or अगरी *agri*. In South-West Shahabad it is डण्डा *danda*. A short bar fastened by a pin to, and revolving on, one leaf of the door, and falling on a nail fixed on the other leaf, is बिल्ली *billi* or बिलैया *bilaiya*. The nail is called मकरी *makri*. A European door-bolt is छिटकनी *chhitkani* or छिटकिनी *chhitkini*. The heavy door-bar sliding back into a recess in the wall is बेंड़ *benr* or बेंड़ा *benra*. South of the Ganges the डेंकी *dhenki*, or in Shahabad डेंका *dhenka*, and in the south-west of that district ठेकुरी *thekuri*, is a perpendicular bar sliding down from a recess in the top of the door-frame. घरन्का *gharku* (in South Munger) is a kind of bolt. The door-lock is ताला *tāla*, and the key कुञ्जी *kunji*, चाबी *chābhi*, or खोरीना *chhorana*. The bolt of the lock is डरन्का *hurka* or (in Shahabad) झार *jhār*. In South Bhagalpur डरन्का *hurka* also means a piece of wood fastening the two door planks behind. When a screen or hurdle, which is टाठी *tāṭi* or टट्टी *tatti* or (to the west) ठठर *thatar*, is used for a door, the spar that supports it inside is बेंड़ *benr* or बेंड़ा *benra*. In Tirhut it is also बेराठी *berāṭhi*, बराठी *barāṭhi*, or (to the east) बेनाठी *benāṭhi*. In South-East Bihār it is बेंड़ाठी *beūrāṭhi* or अड़खड़ *arkhar*, and in South-West Shahabad बेवरा *beūwa*. The straw buffers tied along the two door-posts, against which the edges of the hurdle rest, are मोख *mokh* or मोखा *mokha*.

1251. *The wall.*—A wall is द्विवार *diwār* or भीत *bhit*. Sometimes the Hindi forms दीवाल *diwāl* or देवाल *dewāl* are used. The foundations

are नेव *neo*, and also in Patna and the south-east दावा *dāwa*. The straw mixed with earth for building a mud wall is पाचर *pāchar*, or in Sāran चालन *ālan*. The lumps of damp mud used in building a wall are लौंदा *lonḍa* or धौंधा *dhondha* in Patna, Gaya, and to the west. To the east they are गौंदी *gouḍī*; also चेपी *chepī* in Champaran, चक्की *chakki* in East Tirhut, and लौंदी *louḍī* in South-East Tirhut. In South Tirhut another name is लोइया *loiya*, and in West Tirhut चेकी *cheki*. The stages in which it is built are रदा *radda* or रादा *rāda*, and also optionally पौंड़ *pōir* in Sāran. In Sāran रदा *radda* is the piece of the stage which, being the width of the wall, is finished before commencing the next piece. The top of a wall is भीता *blita* north of the Ganges, and भीन *bhit* south of it; also मँथ *mānth* in South-West Tirhut, and मथनी *mathni* in East Tirhut. The plank over the top of a doorway on which the wall is built is भरौंठ *bharānth*, भरेठ *bhareth*, भराँठ *bharāith*, or भरगठ *bharnath*. In Gaya it is भरगना *bharna*, and in Patna पटन्देहल *patdehal*, of which a local variant in Sāran is पटन्देहर *patdehar*. To the east it is also झनकट *jhankat*. If this plank is not equal in width to the wall, two or more are laid side by side. Then the plank in which the top pivot of the leaf of the door moves is गरन्दानक *gardānak*, or in Champaran उपरौंटा *upraunta*, and the others are called भरेठ *bhareth*, &c. An arched recess in the wall over this plank, and serving as a cupboard, is दुरौंध *duraundh* or दुरौंधा *duraundha*, or in East Tirhut छान *chhāt*. The gable-end wall of a house is पाखा *pākha*, or in Shahabad पाख *pākh*. In North-East Tirhut, however, it is चन्मार *chanmār*, and in Gaya and South-East Bihar कभेटा *kaneta*.

1252. *The eaves.*—These are ओलनी *olti* generally, also ओरी *ori* to the north and west. Another name current in the west is ओरिधानी *origāni*. In Gaya and the south-east they are अग्रौ *agri*, and there and in the south-east ओहारी *ohāri*. The edge of the eave, which is finished off with a board or with a kind of long straw or reed wisp, is known as मोहबत *mohabbat*; also as पसौंड़ *pasauṅar* in North-West Tirhut, पंसरौंड़ *pansrauṅr* in Champaran, and पनिआगर *paniāgar* in North-East Tirhut. The last three words are also used to mean the long bamboo which supports the eave along its lower edge. The pieces of wood let into the wall to support this are टेरचा *terna* generally, and तड़क *tarak* in North-East Tirhut. In Shahabad they are also called मरुचा *marua*. The slope of the roof is तारन *tāran* to the west and गरह *garah* to the east; also गरहगर *garahgar* in North-East Tirhut and तरनगर *tarangar* in Champaran. The raised ground under the eaves is in Gaya अस्थी *asthi*.

1253. *The cupboard.*—This is नाखा *tākha* or नाख *tākh*. A wall-bracket for lamps is दिखरख *diarakh* or दखरखा *diarkha*; also देखर *dekhar* or देखरा *dekhra* in South-West Shahabad, धोरखा *dhorkha* in Patna and Gaya, and धरखा *dharkha* in Gaya and South Munger. In North-East Tirhut it is चक्का *chakka*, and in South-East Tirhut चिरकन्दान *chirakdān*. In North-East Tirhut खरिकौता *kharikautā* is a hole in the wall for keeping tooth-picks. In South-West Bihār and Gaya this is भुरकी *bhurki* or खरकोटी *kharkoti*. मुक्का *mukka*, &c. (see § 1249), is an earthen pot fixed in the wall and used for holding pice, &c.

1254. *The men's and women's quarters, &c.*—The men's quarters are मरन्दाना *marāṇā*, and also मरन्दानी *marāṇī*. Other terms used are दलान *dalān*, दरगजा *darwaja*, or दरौजा *darauja*, दुवार *duār*, and (south-east) बंगला *bangla*. The women's quarters are अन्दरान *andarāt*, जनाना किता *janāna kita*, or हबेली *habeli*. To the east they are also called डेरा *dera*, and (in North-East Tirhut) अँगना *angna*. The part between the two is डेउही *deurhi* or (south-west) देउही *deurhi*. This word is often used to signify a whole house, especially that of some great person, *i.e.*, equivalent to 'palace.' The outer room is also बहार घरा *bahar ghara* or (South-East Tirhut) बन घरा *ban ghara*.

CHAPTER III.—MATERIALS USED IN THE CONSTRUCTION OF THE HOUSE.

1255. Building materials are अमला *amla* or साँगह *sāngah*, or to the south-east साँगठ *sānga*.

1256. *The posts and beams.*—The wooden pillars supporting the roof are खम्भा *khambha*, खम्भी *khambhi*, खम्बिया *khambhiya*, or खम्बिया *khambhiya*. Another name current to the west and in South Tirhut is थून्ही *thūñhi* or थून्हीं *thūñhī*. In North-East Tirhut another name is उचर *uchar*. In South Bhagalpur we find खम्हाँ *khamhāñ*, and in South Munger खम्भी *khāmbhi*. Sometimes to support the ridge-pole a cross-beam runs across from wall to wall, and on its centre stands a pillar, on the top of which the ridge-pole rests. This pillar is also supported by two struts running obliquely from the beam and meeting it half-way up. This beam is called धरान *dharan*, the pillar is called मनिक्थम्भ *manikthambh* or मलिक्थम्भ *malikthambh* or (in Shahabad) also कौरी *kauri*, and the props are called पक्की *pankhi* or in Champaran सिपन्वा *sipna*. When this is found too expensive, two struts run up from opposite walls, and cross

each other just under the ridge-pole, which rests on their upper angle. The struts are called भित्तभेड़ा *bhitbhera*, घोड़मुहाँ *ghormuhān*, or कैची *kainchi* to the west. Other names for similar supports are चटका *hatka* and गोड़िया *goriya* in Shahabad, कौचल *kauwal* in Patna, Gaya, and South-East Tirhut, कडर *kahui* in South-West Shahabad, घोड़सा *ghorsaha* or घोड़ी *ghori* in Champāran and North-West Tirhut, कैच *kainch* in the east generally, and गैच *gainch* in South Bhagalpur. The टेवचा *terua* (or in South-East Tirhut कलन्दरा *kalandara*) is a strut running out from a wall to support the eaves. पाया *pāya* is an earthen pillar for supporting the roof.

1257. The ridge-pole is बड़र *barenr* or बड़री *bareñri*, also लरही *larhi* in Champāran and the south-west, and नरही *narhi* in North-West Tirhut. All the beams of the thatch cross each other over this the upper angle of the cross is filled in with grass, and the whole is tied up tightly. This filling in is called मँगरी *mangri*. The sloping ridge-pole down a corner where two thatches meet is called तड़क *tarak*. A beam running horizontally the length of the thatch along the centre, each end resting on the slope of a gable, is called कमरबल्ला *kamarballa*, also पाड़ *pār* in North-East Tirhut. A lean-to thatch forming the roof of a verandah is supported on a series of struts projecting from the wall, which are called टेवचा *terua*, माला *māla*, मलवा *malua*, मडुआ or मरुआ *marua*, or मंडुआ *mañrua*, which support a long beam or bamboo, called सरन्दर *sardar*, on which the thatch rests.

1258. The round rafters of a thatched house are बल्ला *balla*, also बाला *bāla* in Shahabad. Thick squared rafters are known as कड़ी *kari*. The rafters of whole bamboos are कोरा *kora* or कोरो *koro*. The thickest of split bamboo are बाता *bāta* or बत्ता *butta*, and the thinnest laths of bamboo are बाती *bāti* and बत्ती *batti*, also in North-East Tirhut भौंजन *jhonjhan*. निगस्ता *nigasta* is a thick rafter used in South-West Shahabad; बरगा *barga* are the thinner rafters used in supporting a flat *pakka* roof. बल्ली *balli* are rafters smaller than a बल्ला *balla*.

1259. The round poles built up inside mud walls are लेवा खाही *lewa khāmhi* north of the Ganges. In Shahabad they are गोल *goi* or गोला *gola*, and so also in the south-east. In Patna they are लार *lār*, and in South Bhagalpur नार *nār*. The support of a broken wall is अस्थम *astham* or चाँड़ी *chāñri* north of the Ganges; also चाँड़ा *chāñra*, उचका *uchka*, or थमुआ *thamua* in South-East Tirhut. In Shahabad this is थुन्ही *thūñhi*, in Patna and Gaya थुम्भी *thumbhi*, in South Bhagalpur

थम्बुआ *thambua* or चाँडा *chānda*, and to the south-east ओठगनी *othga*, or ओठगन *othgan*.

1260. गोल *gol* or गोला *gola* are round beams, and चौकोर *chauko*, or चौपहल *chaupahal* squared beams. The latter are also called चौघा *chaudhār* in Shahabad. A crooked beam is said to be कुबड़ *kūbar* in Shahabad.

1261. In South West Shahabad चेंडा *cheṅṅa*, in South Bhagalpur चेला *chela*, and elsewhere south of the Ganges चैला *chaila* or चैली *chaili*, are splinters of wood, a layer of which is placed between the rafters and the tiling, and is also used for fuel.

1262. *The tiles.*—These are खपड़ा *khapra* generally. Flat tiles are थपुआ *ihapua*, or in Champaran पथुआ *pathua*, and in South Munger सुपतिआ *supatiya*. Another name is पटन्नी *patri* in South-West Shahabad. Semi-circular tiles are नरिया *nariya* generally, and pointed eave-tiles are टौंटी *touti* or (Shahabad) टौंटियारी *tontiyāri* south of the Ganges. In the north-west औंधा *aundha* is a rough mode of tiling, when only flat tiles are used. In Gaya मुंगरा *mungra*, and in Sāran मंगरा *mangra*, is a large kind of tile laid along the ridge of a roof. Bits of broken tiles are मरकन *markan* to the north-west, and झिटकी *jhituki*, झुटका *jhutka*, or झुटकी *jhutki* to the north-east. South of the Ganges they are ठिकरी *thikri* or झिकटी *jhikti*. In Shahabad they are झिकरी *jhikri* or सिकरी *sikri*. Tiles are baked in a kiln, called आवा *āva* or (South-West Shahabad) आँवाँ *ānwān*. The layer of loose grass on a tiled roof between the rolls of thatching-grass and the tiles are known south of the Ganges as तरेर *tarer* or तरेरा *tarera*, or (in South Bhagalpur) पटोतन *patotan*. In the north-west it is फटकन *phatkan*, and in Tirhut चरन *chharan*.

1263. *The bricks.*—These are ईटा *inta* generally, local variants being ईंट *int* or ईटा *ita* south of the Ganges, and ऐंटा *ainta* in Patna, Gaya, and South Munger. A well-known proverb is मन में आन बगल में ईटा *man meñ ān, bagal meñ inta*,—(pretending to have) something else in one's mind, and having really a brick under one's arm (to heave at you). Among the varieties are पक्का *pakka* or पाकल *pākal*, which are kiln-burnt (the first word is borrowed from Hindi), and कच्चा *kachcha* (also Hindi) or काँच *kānch*, which are sun-dried. Another classification is into अंगरेजी *angreji* or बड़का *barka*, which are large table-moulded bricks. These are also called गढ़िया *gadhiya* in Patna and South Bhagalpur, and टाली *tāli* in South Munger. Common country bricks are देहानी *dehāni*, or in South-East Tirhut भुरखोट *bhūlot* or पनगिआ

paingija. सौंदर *saundar* in Patna and the south-east is a yellow kind of country brick. The smallest-sized country bricks are लखौरी *lakhauri* or लखौरि *lakhauri* to the west, पजार् *pajāi* in South-West Tirhut, लखौरी *lakhauri* in East Tirhut, खजन्वा *khajwa* in South-East Tirhut, and ठिकड़िया *thikariya* in Patna and the south-east. The bricks forming the segment of a circle, used for lining wells, are known as बकौ *bakau*, बँकौ *bankau*, बकन्वा *bakwa*, or बँकन्वा *bankwa*. In South-East Tirhut these are known as चाकौटा *chākautā* or कौठिया ईंटी *kothiya inta*. सुरजन्मुखी *surajmukhi*, or in Champāran गेँदुआवा *geṅṅuāwa*, are the bricks, narrow at one end and broad at the other, used in building the sides of wells.

1264. In the interior of Patna थवाई *thawai* is the name of the bricklayer caste. Bricks are burnt in a kiln, called पजावा *pajāwa*, पिजावा *pijāwa*, पिजन्वा *pijwa*, भट्टा *bhattha*, or भाठी *bhāthi*. An over-burnt brick is भाँवाँ *jhāñcāñ* north of the Ganges, and भासा *jhāsa* south of it. Local names are भास *jhām* in East Tirhut and भासो *jhāso* in South Bhagalpur. Half-fired bricks are पीयर *pīyar* or पियरा *pīyara*, other local names being भुसुरिया *bhusuriya* or सेवराहा *sewrāha* in Champāran, सेवर *sewar* in Shahabad, पीला *pīla* in Gaya, अवालू *awālū* in Patna, and कचकोह *kachkoh* in South Bhagalpur. Other names are भटरङ्ग *bhatrang* in North-West Tirhut and भुसरङ्गा *bhusraṅga* in South-East Tirhut. The outer bricks of a kiln which become half black or are partially fired are called बाल के ईंटा *chhāl ke inta*, and in South Bhagalpur also छालन्टी *chhānti*.

1265. *Stone*.—Stone is पत्थर *patthar* or पत्थल *patthal*. Slabs of stone are पटिया *patiya* or सिन्धी *silli*. When large they are also called चीरा *chira* in Shahabad, and असार *asār* in Patna and Gaya. Small pieces for jambs and lintels are टोड़िया *toriya* in South-West Shahabad, टूटन *tūtan* in the rest of that district, वचर्री *kachri* in Gaya, and डोका *dhoka* in Patna.

1266. *Lime and mortar*.—The calcareous nodular limestone used for lime-making and road-metal is known generally as कङ्कड़ *kankar*, local names being आँकड़ *ānkar*, दकण्डी *ikri*, or ईँकण्डी *inkri* (also in South-East Tirhut) to the west, गङ्गट *gangat* in Patna and Gaya, and गौंगट *gūngat* to the south-east. Large blocks of it are known south of the Ganges as चट्टान *chattān* or चटान *chutān*, also as लईन *lain* in South-West Shahabad. The small pieces for road-making are आँकण्डी *ankri* or आँकड़ *ānkar* in Shahabad, कँकण्डी *kankri* in Gaya, and in Patna, Gaya, and the south-east simply लोड़ा *lora* or रोड़ा *rora*, which last may also

apply to small lumps of bricks, &c., also used in road-making. **खरन्ना** *chharra*, or in the south-east **बालिस** *bālis*, is coarse limestone gravel.

1267. Lime is **चून** *chūn*, **चूना** *chūna*, or **चुन्ना** *chunna*. It is of two varieties, viz. **गिट्टी** *gitti*—that made from limestone, and **कली** *kali*—that made from shells. In the south-east that made from gravel is also called **कली** *kali*. The mussel shell used for making lime is **सीपी** *sipi* north of the Ganges, and **सितुचा** *situa* or **सितुहा** *situha* south of it. A local name is **सित्तू** *sittu* in South Bhagalpur. **घोंघा** *ghongha*, **ऐठा** *aitha*, or **ऐँठा** *aintha* is the voluted shell of a kind of water-snail similarly used. Lime mortar is **मसाला** *masāla*, or in Patna **दबोइ** *daboi*. Plaster is **लेदाल** *ledāl* or **नीपे** *nipe*. Moistened clay used as mortar is **गिलावा** *gilāwa*, or in South Munger **गिलेवा** *gilewa*. In Patna, Gaya, and the south-east it is also called **गारा** *gāra*. The pounded bricks used as a substitute for sand is **सुरखी** *surkhi*. When a wall is whitewashed it is said to be **पोचारा वाला** *pochāra wāla*, **चुनेटल** *chunetal*, **चुनवटल** *chunvattal*, or **चूना फरल** *chūna pheral*.

DIVISION XI.

FOOD.

CHAPTER I.—MEALS.

1268. The general term for a *meal* is रसोद *rasoi*; also भानस *bhānas* in East Tirhut. The *morning meal* is नाशन्ता *nāshṭa*. Other names are पनपियाव *panpiyāo*, पनपियाइ *panpiyāi*, जलपान *jalpān*, जलखई *jalkhāi*, and जलखावा *jalkhāva*. Other local names are जलघेराव *jalgherāv* (Champāran), पनपियाइ *panpiyār* (Gaya), and दाना *dāna* or दाना दूनी *dāna dūni* in Shahabad. पनपियाइ *panpiyār* is also used to mean the food eaten by the labourer in the intervals of work in the field. This in the west is also called लुकुम *lukum*.

1269. The *midday meal*, which is the main meal of the day, is called by the people कलेवा *kalwa*, कलेज *kalju*, or (in Tirhut) कलौ *kalau*, though according to dictionaries and pandits this is a light morning repast. Local names for this meal are खाय *khāy* in Patna, खैया *khāiya* in Gaya, खाइक *khāik* in South Munger, and कलौआ *kalua* in South Bhagalpur.

1270. An *evening meal* is संझौआ *sanjhāua* in South-West Shahabad. बेआलू *beālu*, or in Champāran बरहटिया *berhatiya*, is light food taken just before sleeping.

1271. A *mouthful*, or the quantity of food put into the mouth at once, is कोर *kor*, कवर *kawar*, or कौर *kaur*. In South-West Shahabad it is also नवाला *newāla*, which, however, means in the interior of Patna the refuse food left, after eating, for servants, and which is then also called जलुस *ūlus*.

CHAPTER II.—KINDS OF FOOD.

1272. The following are the principal kinds of food consumed by the lower orders:—

अकरी *akri*, एकरी *ekri*, or एंकरी *enkri*,—uncleaned rice.

अखरी *akhri* or (South Munger) अखरा *akhra* or (South Bhagalpur) अखरो *akhro*, also आँवट *āṅwat* (North-West Bihār and South-East Tirhut),—barley ground without being first cleaned. Cf. गुरी *gūri*.

अदौरी *adāuri* or (Shahabad) अद्वरी *advāri*,—little round balls made of pulse.

अनाज *anāj*,—a general term for food, especially grain.

अन्न *ann*,—food generally, especially corn.

अमावट *amāvat* (west), अमोट *amot* (North-East Tirhut),—mango conserve.

अरकौंच *arkaunch*,—see रिकौंच *rikaunch*.

अरन्दावा *ardāwa*,—gram and barley mixed and parched. Used as a food for horses.

अमाँठी के रोटी *amān̄thi ke roti*,—see आँठी के रोटी *ān̄thi ke roti*.

आँटा *ānta* or आटा *āta*, पिमान *pisān*, कनि क *kanik* or (East Tirhut) चिकस *chikas*, and (South Bhagalpur) चिकसा *chiksa*,—flour or meal.

आँठी के रोटी *ān̄thi ke roti*, also किमन्ली के रोटी *kisli ke roti* (Champaran), अमाँठी के रोटी *amān̄thi ke roti* (Gaya and South Munger), and गुम्मा *gumma* (South Bhagalpur),—bread made of crushed mango-stones.

आमिल *āmil* (North-East Tirhut), खटार *khatai* (Sāran), and खट्टा *khatta* (South Bhagalpur),—dried chips of the mango fruit used as a conserve. It is of two kinds, दड़िमी *darimi* and खोरया *khoiya*. The first is made from small immature mangos (टिकुला *tikula* or टिकोड़ा *tikorha*), and the second from large mangos.

आँवट *āṅwat*,—see अखरी *akhra*.

ओग्रा *ogra*,—see माँड़ *mān̄r*.

ओरन्हा *orha*,—see होरन्हा *horha*.

इमरिती *imriti*,—see जिलेबी *jilebi*.

इंगूर *ingūr* or इंगुरी *inguri* (north),—barley from which the husk has been removed by pounding.

उफिला *ujhila*,—cooked mustard-seed.

ऊमी *ūmi*,—green *marua* (*cleusine coracana*) roasted as food (see § 990).

उलवा दाह *ulwa dāl*, उलवावल *ulāwal*,—see दाह *dāl*.

एकरी *ekri*, ऐकरी *enkri*,—see अकरी *akri*.

कचननिचा *kachvaniya* (Sāran, Patna, and South Munger), मोदक *modak* (Gaya and Shahabad), कसार *kasār* (South Munger),—a round sweetmeat made of rice-flour, sugar, and clarified butter.

कचरस *kachras* (north-west) or पनुआँ *panuāñ* (South-West Shahabad),—sugar-cane juice mixed with water.

कचौड़ी *kachauri*,—cakes of flour filled with pulse, &c. The inside stuffing of pulse-flour, &c., is called पीठी *pithi* south of the Ganges.

कहुवा *karhua* (south),—food saved from supper for the children.

कबूली *kabūli*,—see खिचन्दी *khichri*.

कनिक *kanik*,—see आँटा *ānta*.

कसार *kasār*,—see कचननिचा *kachvaniya*.

काँची *kānchi*,—see हलुवा *halua*.

किसली के रोटी *kisli ke roti*,—see आँठी के रोटी *ān̄thi ke roti*.

कुन्ती *kunti*,—see लार *lāi*.

काँचरौरी *konhrauri*,—cakes made of ground pulse and pumpkin.

खजन्ना *khajla* (north),—a sweetmeat made from wheat-flour.

खजूर *khajūr*, also (south of the Ganges) खुरमा *khurma* or (South Bhagalpur) झिलिया *jhiliya*,—a sweetmeat in the form of a date.

खटार *khatāi*,—see आमिल *āmil*.

खंड़ौरा *khunraura*,—see खुद्दी *khuddi*

कबांनी *khabauni* (south),—a sweet cake of wheat.

खाजा *khāja* (north),—a sweetmeat made from wheat-flour.

खिचन्दी *khichri*,—rice boiled with pulse; also called कबूली *kabūli* or भूनल खिचन्दी *bhūnal khichri* when spices are added. This last is called चॉकी *chhauki* (*i.e.* seasoned) in South Bhagalpur.

खिरौरा *khiraura* (South-West Shahabad),—cakes of rice-flour prepared in hot water. Sometimes spelt खिरवरा *khiravara*.

खीर *khīr*, also खीरि *khīri* in North-East Tirhut and बखीर *bakhīr* south of the Ganges,—rice boiled in milk with sugar. See also जाडर *jadūr* and तसन्दी *tasmāi*.

खुरी *khuddi*, also (South-West Shahabad) खंजौरा *khanraura*, and South Munger मेरखुन *merkhun*,—broken pulse or rice.

खुरमा *khurma* or South Munger खोरमा *khorma*,—a sweetmeat in form of a date made of wheat-flour, sugar, and clarified butter. Cf. खजूर *khajūr*.

खुशका *khushka*,—see भात *bhāt*.

खुसकी *khuski*,—see परन्धन *parthan*.

खोभिया *khobhiya*,—see लार *lāi*.

खोइया *khoīya*,—see आमिल *āmil*.

गटा *gatta*,—a cheap sweetmeat made of molasses. They are sold for a *kauri* each, and are the delight of boys of the poorer classes.

गलबल *galbal*,—see डभका *dabhka*.

गुम्मा *gumma*,—see आँठी के रोटी *ān̄thi ke roti*.

गुरी *gūri* (Shahabad),—barley ground after being cleaned, Cf. अहरा *akhra*.

गुलगुला *gulgula*, also (Shahabad) गुलौरा *gulaura*,—a pudding of wheat and sugar.

गुलदाना *guldāna* (north-west), also इलाइची दाना *ilāichi dāna* (Sāran and South-West Tirhut), and मकुन्दी दाना *makundi dāna* (Patna),—a sweetmeat made of wheat.

गुलाब जामुन *gulāb jāmun*,—a long sweetmeat made of dry curds (खेना *chhenu*).

गुली *gulli*,—see खोइया *loīya*.

गुलौरा *gulaura*,—see गुलगुला *gulgula*.

गोभा *gojha* (north and south-west), also गोभिया *gojhiya*,—a kind of sweet cake. See also फरा *phara*.

घटरा *ghatra*, घटोरा *ghatora*,—see पूषा *pūa*.

घटा *ghattha*,—see खपन्ची *lapsi*.

घटिहन *ghatihan*, घठिहन *ghathihan*,—a general term for cheap grain, such as barley, pease, &c., also (Sāran) any kind of grain which when ground absorbs much water and is not easily digested

घटोरा *ghatora*,—see पूषा *pūa*.

घसुआ *ghasua* or घसुरं रोटी *ghasur̄i roti*, also पोहूआ *pochhua* (Tirhut)

and सोहारी *sohāri* (East Tirhut and Shahabad),—cakes fried in a little clarified butter or oil.

घाठ *ghāth*, घाठा *ghātha*, घाठो *ghātho*,—see लपन्सो *lapsi*.

धाठि *ghāthi*,—see बेसन *besan*.

घाँठो *ghāntho*,—see लपन्सो *lapsi*.

विघौड़ा *ghiyaura*, घौवर *ghūvar*, घुगुरी *ghuguri*,—see घेवर *ghewar*.

घुघुनी *ghughni* (north and south-east),—a mess made of pulse, clarified butter, &c.

घेवर *ghewar* (north), घुगुरी *ghuguri* (South-West Shahabad), विघौड़ा *ghiyaura* (Patna and Shahabad), घौवर *ghūvar* (Gaya and south-east),—a sweetmeat made of wheat-flour.

घोर *ghor*, घोल *ghol*,—see मट्टा *mattha*.

घोरन्जावर *ghorjāūr*, घोरन्जारी *ghorjāri*,—see मटन्जावर *mathjāūr*.

चक्का *chakka*,—see बजन्का *bajka*.

चटनी *chatni*,—“chutnee.”

चबेना *chabena*, चबेनी *chabeni*, चरन्बन *charban*, or भूँजा *bhūnja*, also भुजना *bhujna* (Shahabad) and मूही *mūhi* (South Bhagalpur), भूजा *bhūja* (North-East Tirhut),—parched grain.

चिकस *chikas*, चिकन्सा *chiksa*,—see आँटा *ānta*.

चिकस *chikkas* (north),—roasted barley ground up with unroasted barley.

चिउरी *chiuri* (north-west), चौरि *chauri* (South Tirhut), फरुही *pharuhi* (East Tirhut and Shahabad), फरुही *pharhi* (Patna and Gaya),—unripe barley parched ; but in South Bhagalpur, फरुही *pharuhi* is parched rice.

चुनी *chunni*,—see चून *chūn*.

चूड़ा *chūra*,—unhusked rice, parched, then moistened and pounded flat.

चून *chūn* (north-west), चुनी *chunni* (Patna, Gaya, and South Munger), and राई *raī* (Shahabad),—rice partially boiled, then pounded and roasted.

चोखा *chokha* or भरन्ता *bharta*, also (East Tirhut) सना *sana*,—a mess of pounded roasted vegetables.

चोंथा *chontha* (Sāran),—a dish of pulse.

चौरी *chauri*,—see चिचुरी *chiuri*.

चौरैठा *chaurētha*, चौरथ *chaurath*,—rice soaked in water and then dried and pounded.

चनका *chhanka*, चवन्कन *chhewkan*, चवैकना *chhewankna*, चौकल *chhaunkal*, चौका *chhaunka*,—see बघार *baghār*.

चेना बाड़ा *chhena bāra*,—round flat sweetmeats made of dry curds (चेना *chhena*); a Bangāli dainty adopted in Biḥār.

चौकी *chhaunki*,—see खिचरुई *khichri*.

जवाखार *javākhār* (south) or पाचक *pāchak* (South Bhagalpur),—ashes of burnt ears and stalks of barley, used as a cure for indigestion.

जावर *jāūr*,—rice boiled in milk with salt. When boiled with sugar it is खीर *khīr*, *q.v.*

जाबर *jābar*,—a mess of rice, vegetables, clarified butter, &c.

जिलेबी *jilebi*,—a tubular sweetmeat in a coiled shape, made of fine wheat-flour, sugar, &c. A variety of it is known as इमिरिती *imriti* or इमिरन्ती *imirti*.

भाँभा *jhānjha* (South-West Shahabād),—a mixture of coarse sugar, hemp, clarified butter, &c.

भिलिया *jhiliya*,—see खजूर *khajūr*.

भिल्ली *jhilli*,—see लट्टा *latta*.

भोर *jhor*,—see परेह *pareh*.

टूका *tūka* (north) or (East Tirhut) टुकरी *tukri*,—the fourth part of a round cake.

टिकरी *tikri*,—a sweetmeat made of flour, fried in clarified butter or oil, and covered with sugar; also (Gaya) a small loaf or roll. In South Bhagalpur it is a round sweetmeat in the form of a cake, and made of flour, butter, and sugar. Another name for this last is टिकिया *tikiya*.

ठकुआ *thakua*,—see ठेकुआ *thekua*.

थुररी *thurri*,—see ठूरी *thūri*.

ठूरी *thūri*, or (Tirhut, Gaya, and South Munger) थुररी *thurri*, (South-West Shahabād) ठोरी *thori*, (Patna) मुररी *murri*, and (South Bhagalpur) मूदी *mūrhi*,—grain which has not burst while being parched.

ठेकुआ *thekua*, ठकुआ *thakua*,—a kind of cake pressed in a mould called अगरीटा *agarāta*.

थोरी *thori*,—see थूरी *thūri*.

डभका *dabhka* (north-west), गलबल *galbal* (South Tirhut), डभकल *dabhkal*,—parched unripe grain, or ripe grain soaked in water and parched.

डुप्पा *duppha*,—see महुआर *mahuar*.

तक्कर *takkar*,—a preparation of butter-milk with spices, &c. It is said to be very cooling.

तरल *taral* (North-East Tirhut),—a kind of dish consisting of vegetables cooked in clarified butter or oil. It is peculiarly a rich man's food, and is supposed to be fattening, hence the proverb तरल खाय, पुनु गरल जाय *taral khāy, punu garal jāy*,—he is a rich man, and yet he is lean.

तसमई *tasmaī*,—rice boiled in milk with sugar, usually eaten by mendicants. It differs from खीर *khīr* in that the latter may or may not have water added.

ताज खानी *tāj khāni*,—see तास खानी *tās khāni*.

तास खानी *tās khāni* (north), also (South-East Tirhut) ताज खानी *tāj khāni*,—a round sweetmeat made of rice-flour, sugar, and clarified butter.

तिलकतरी *tilkatri*,—see लार *lāi*.

तिलकुट *tilkut*,—a sweetmeat made of sesamum and molasses, much eaten by boys in Patna.

तिलौरी *tilauri*,—small balls of *urid* or *mung* mixed with sesamum seed, dried in the sun, and then fried in clarified butter.

तिसजौरी *tisjauri* (South Tirhut) or तिसियाउर *tisiyāūr*,—linseed and rice cooked together.

दड़िनी *darini*,—see आमिल *āmil*.

दमजाउर *danjāūr* (Sāran and South-West Tirhut),—poppy-seeds (दाना *dāna*) and rice cooked together.

दऔरी *danauri*,—the same as तिलौरी *tilauri*, poppy seeds being used instead of sesamum.

दरा *dara*, दररा *darra* (north),—coarse meal; but दररा *darra* south of the Ganges is pounded maize boiled with water and sugar.

दलपिठ्ठी *dalpitthi*, दलपिठ्ठीरी *dalpithauri*,—see दाल पीठी *dāl pīthi*.
दलसग्गा *dalsagga* or (South-West Shahabad) सगन्पहिता *sagpahita*,—
pulse boiled with vegetables.

दलकी पूरी *dalhi pūri*,—see बेरन्ही *berhi*.

दाल *dāl*,—split pease or pulse. When these are parched they are called उलावाल दाल *ulāwal dāl* or उलान्वा दाल *ulua dāl*.

दाल पीठी *dāl pīthi*, दलपिठ्ठी *dalpitthi*, or (Shahabad) दलपिठ्ठीरी *dalpithauri*,—(1) balls of wheat or barley-flour stuffed with pulse inside and boiled in water; (2) balls of wheat or barley-flour cooked along with pulse. पीठा *pītha* means balls of meal boiled in water.

धुन्धार *dhuñāūr*,—see फोरन *phoran*.

धोखल दाल *dhoal dāl*, धोखँच *dhoānch*,—see धोई *dhoī*.

धोई *dhoī* (north and Shahabad), also धोखँच *dhoānch* (South-West Shahabad), elsewhere धोखल दाल *dhoal dāl*,—soaked pulse.

धोंग *dhong* (Shahabad),—a thick cake.

पकमान *pakmān* or पकवान *pakvān*,—sweetmeats.

पतौरा *pataura*,—the tops of the plant called गुग्गा *gumma* (*pharnaceum mollugo*) roasted in a castor-oil leaf.

पतुखँ *panuān*,—see कचरस *kachras*.

पपन्ना *papra*,—see पापर *pāpar*.

परकिया *parakiya*,—see समोसा *samosa*.

परन्धन *parthan*, also Gaya पलेथन *palethan*, and हसन्की *khuski*,—the dry flour rubbed on the dough as it is being made into cakes.

परन्मल *parmal* (Shahabad),—parched maize or grain. See also होरन्हा *horha*.

पराठा *parātha*,—see फराठा *pharātha*.

परेह *pareh*, रस्सा *rassa*, रासा *rāsa*, or भोर *jhōr*, sauce, such as of vegetables, &c., eaten with dry food.

पलेथन *palethan*,—see परन्धन *parthan*.

पाम *pāg* or (south-east) राम *rān* or (South Bhagalpur) सिरा *sira*,—syrup made by melting sugar in water and boiling it down.

पाचक *pāchak*,—see जवाखार *jawākhār*.

पापर *pāpar* or पपन्ना *papra*,—a crisp cake of pulse flour.

पिठार *pithār* (North-East Tirhut),—rice pounded in water.

पिठ्ठा *pittha* or पीठा *pitha*, also to the east बगिया *bagiya*, and in Tirhut बगेया *bageya*,—a kind of boiled pudding made of *sattu* or meal. A smaller variety is called पिठ्ठी *pitthi*.

पिठ्ठी *pitthi*,—see पिठ्ठा *pittha*.

पिसान *pisān*,—see आँटा *ānta*.

पीच *pīch*,—see मॉड़ *mānr*.

पीठा *pitha*,—see पिठ्ठा *pittha*.

पीठी *pīthi*,—see कचौड़ी *kachauri*.

पूषा *pūa*, also (East Tirhut) पू *pū*, and घटोरा *ghatora* (Patna and Gaya), and घटत्रा *ghatra* (South Bhagalpur and Gaya),—wheat-flour and molasses mixed and cooked in clarified butter or oil. Cf. माल पूषा *māl pūa*.

पूरी *pūri*, also (north) लुचुई *luchūi*, and (Tirhut) सोहारी *sohāri* or सुहारी *suhari*,—thin cakes boiled in clarified butter. They are supposed to be as indigestible as muffins: hence the proverb about one who attempts things he cannot do, अ पचे नचिँ, पूरी खा मारि *ghyū pache nahū pūri la māri*,—a fight for muffins, when even clarified butter wqn't digest.

पेठा *petha* (north), also सुष्पापाग *thuāpāg* (South-East Tirhut),—candied gourd.

पेड़ा *pera*,—a sweetmeat made of sugar and milk. Those made in Mathura and Gaya are most esteemed. See also लोरया *loiya*.

फरन्ही *pharhi*,—see चिउरी *chiuri*.

फरा *phara* (north-west), गोभा *gojha* (Shahabad), and बगिया *bagiya* (South Bhagalpur),—balls of rice steamed over a pot containing boiling water.

फराठा *pharātha* (north and south-east), पराठा *parātha* (elsewhere),—bread made like pie-crust.

फरुही *pharūhi* (South Bhagalpur), फोकना *phokna* (South Munger),—parched rice. See also चिउरी *chiuri*.

फुटपूरी *phutpūri*,—see बरन्ही *berhi*.

फुटत्रा *phutahra*,—see लिट्टी *litti*.

फुटन्हा *phutha* or (South-West Shahabad) फुटत्रा *phutahra*,—parched gram and pease.

फुटन्ही *phutehri*,—see लिट्टी *litti*.

फुलौरा *phulaura*,—large balls of *urid*-flour fried in clarified butter or oil, and then soaked with spices in tyre. It becomes very spongy.

फुलौरी *phulauri*,—(1) (south) a roll of coarse flour cooked by steam in a pot with some water in the bottom, and resting above on twigs; (2) (north) balls of pulse-flour boiled in clarified butter or oil.

फेनी *pheni*,—a frothy sweetmeat made of wheat-flour and sugar. See also बत्तास फेनी *batās pheni*.

फोकना *phokna*,—see फरही *pharuhi*.

फोरन *phoran*, also (Shahabad) धुन्धौर *dhunāñr*,—seasoning used with food.

बखीर *bakhīr* (South-West Shahabad), रसियाब *rasiyāo* (rest of Shahabad), रसिया *rasiya* (Patna, Gaya, and the south-east),—rice cooked in sugar and water. See also खीर *khīr*.

बगिया *bagiya*, बगेया *bageya*,—see पिट्ठा *pittha*.

बघार *baghār* (north-west), च्येकन *chhenkan* (Tirhut), च्येकना *chhewankna* (Patna), च्येकल *chhaunkal* (South Munger), चनका *chhanka* or च्येका *chhaunka* (South Bhagalpur),—the act of seasoning food

बचका *bachka*,—see बजका *bajka*.

बजका *bajka* or (Patna) बचका *bachka*, (north चक्का *chukka*, (North-West Tirhut) बरा *bara*, (South Bhagalpur) बारा *bāra*,—slices of gourd or vegetable covered with pulse-flour and then fried in clarified butter or oil.

बत्तास फेनी *batās pheni* or फेनी *pheni* (north),—a spongy sweetmeat made of sugar and flour.

बत्तासा *batāsa*,—a spongy sweetmeat made of sugar.

बफौरी *baphauri*,—pulse-flour cooked by steam.

बरजौर *barjanr*,—see बरेचिन *berhin*.

बरफौ *barphi*,—a white sweetmeat made of wheat, flour, milk, and sugar.

बरा *bara* or बारा *bāra*,—cakes of *urid* pulse fried in clarified butter or oil. See also बजका *bajka*.

बरी *bari*,—balls of *urid*, *mūng*, or gram-flour fried in clarified butter or oil.

बलुसाही *balusāhi* or बालू साही *bālu sāhi*,—a sweetmeat made of wheat.

बसिया *basiya*,—see बासी *bāsi*.

बहुरी *bahuri*,—see होरन्हा *horha*.

बारा *bāra*,—see बजन्का *bajka* and बरा *bara*.

बालू साही *bālu sāhi*,—see बलुसाही *balusāhi*.

बासी *bāsi* or बसिया *basiya*, also (Shahabad) बासी कूसी *bāsi kūsī*,—food saved from supper for breakfast.

बीरी *biri* (Gaya), a kind of food made of leaves and flour fried in clarified butter.

बुनियाँ *buniyān*,—a small round hollow sweetmeat made of gram-*besan*, fried in clarified butter or oil and covered with sugar.

बेनिया *beniya*,—see बेरन्ही *berhi*.

बेरन्दिन *berhin* or बरन्जौर *barjaur* (Shahabad),—pulse cakes.

बेरन्ही *berhi*, दलन्ही पूरी *dalhi pūri* (north), फुटपूरी *phutpūri* (South Bhagalpur), and also (Tirhut) बेनिया *beniya*, and (Shahabad) बेरन्हीया *berhiya*,—pulse-flour cooked inside a wheat cake.

बेसन *besan* or घाठि *ghāthi* (North-East Tirhut),—pulse-flour.

बोर *bor* or बोर बोर *bor bor* (Gaya and west), सानि *sāni* (South Bhagalpur), सोन *son* (South Munger), the act of soaking dry food, such as bread, in any liquid.

भभरी *bhabhri*,—see लिट्टी *litti*.

भात *bhāt* (amongst Hindus), खुशन्का *khushka* (amongst Musalmāns),—plain boiled rice.

भुषापग *bhuūpāg*,—see पेठा *petha*.

भुजन्ना *bhujna*, भूजा *bhūnja*, भूजा *bhūja*,—see चबेना *chabena*.

भूनल खिचन्दी *bhūnal khichri*,—see खिचन्दी *khichri*.

मण्डा *maēda* or मैदा *maīda*,—fine sifted flour.

मकुनी *makuni* (1) (north),—cakes stuffed with gram-flour; (2) (south) cakes made of pease or wheat-flour. See also लिट्टी *litti*.

मटन्नी *matri* (north), मुठन्नी *muthri* (South-West Shahabad),—a sweetmeat made of wheat-flour.

मट्ठा *mattha* or माठा *mātha*, also मण्ठा *mantha* (South-West Shahabad), घोल *ghol* or घोर *ghor* (to the east), and मही *mahi* (South Tirhut),—butter-milk.

मठञ्जाउर *mathjāūr*, also (east) घोरञ्जाउर *ghorjāūr* and (South Bhagalpur) घोरञ्जारी *ghorjāri*,—butter-milk boiled in water, with a little rice, &c., added.

मठरी *mathri*,—see मठरी *matri*.

मईंसटका *marsatka* (Gaya),—rice-gruel with the rice.

मण्ठा *mantha*,—see मट्ठा *mattha*.

महन भोग *mahan bhog*,—see हलुआ *halua*.

महियाउर *mahiyāūr* (north) and महेर *maher* South-West Shahabad),—a mess of rice, &c., in butter-milk.

महुअर *mahuar* or (South Bhagalpur) डुप्पा *duppha*,—the flowers of the *mahua* (*Bassia latifolia*), soaked over-night, crushed next morning, and made into a cake with flour, gram, pease, or linseed.

महेर *maher*,—see महियाउर *mahiyāūr*.

माठा *mātha*,—see मट्ठा *mattha*.

माँड़ *mānr* (amongst Hindus) and पीच *pīch* or ओग्रा *ogra* (amongst Musalmāns),—rice-gruel.

माल पूआ *māl pūā*,—wheat-flour, sugar, and milk mixed and cooked in clarified butter only, thus differing from पूआ *pūa*, *q.v.*

मीठी पूरी *mīthi pūri*,—sweet cakes.

मुररी *murri*,—see ठूरी *thūri*.

मूदी *mūdi*,—see ठूरी *thūri*, चबेना *chabena*, and लार *lāi*.

मेरखुन *merkhun*,—see खुदी *khuddi*.

मैदा *maida*,—see मण्डा *māda*.

मोती चूर *moti chūr*,—a sweetmeat made up of very fine बुनियॉ *buniyān* shaped like pearls.

मोदक *modak*,—see कचवनिआ *kachwaniya*.

मरं *rai*,—see चून *chūn*.

रस गोला *ras gola*,—round balls of dry curds (हेना *chhena*) in syrup; a Bangāli dainty adopted in Bihar.

रसिया *rasiya*, रसियाव *rasiyāo*,—see बखीर *bakhīr*.

रसा *rassa*, रासा *rasā*,—see परेह *pareh*.

रान *rān*,—see पाग *pāg*.

राव *rāb*,—boiled sugar-cane juice.

रिक्कौच *rikaunch* or सैदा *saindha* (north), also अरक्कौच *arkaunch* (Tirhut),—a mess of pulse-flour cooked in the leaves of the अरुई *arui* (*Arum colocassia*).

लकठो *laktho*,—see सेव *seo*.

लहा *latta* or लाटा *lāta*, also (South Bhagalpur) जिहो *jihī'*,—a mess made of the flowers of the *mahua* (*Bassia latifolia*), molasses, and parched grain.

लड्डू *laddu* or लड्डुआ *larua*,—a sweetmeat made up of sugar and cream.

लपन्धी *lapsi*,—flour of any grain boiled in milk and eaten with sugar. When made with salt instead of sugar, it is called (South-West Shahabad) घाठ *ghāth*, (South-East Tirhut) घट्ट *ghattha*, (South Munger) घाठा *ghātha*, and (South Bhagalpur) घाठो *ghātho* or घाँठो *ghāntho*.

लार *lāi*, also (Tirhut) मूही *mūhi*, कुन्ती *kuntī* (Patna and the south-west), and तिलकृतरी *tilkatrī* (South Bhagalpur) and खोभिया *khobhiya*,—parched rice prepared with sugar south of the Ganges, but without it north of the Ganges.

लाटा *lāta*,—see लहा *latta*.

लावा *lāva*,—maize, rice, &c., parched in hot sand.

लिट्टी *litti*, भभरी *bhabhri*, मकुनी *makuni*, or फुट्टेहरी *phutehri* or (south) फुट्टेह्रा *phutahra*,—various cognate kinds of cakes fried in hot ashes. The last four are generally stuffed with *sattu* and spices, while the first may or may not be so stuffed.

लुचुई *luchūi*,—see पूरी *pūri*.

लोइया *loīya* or (South Bhagalpur) गुली *gulli*, the lumps of dough out of which cakes are made. In Patna, Musalmāu women call them पेड़ा *pera*.

सकरपला *sakarpāla* or (Gaya) निरजई *mirjāi*,—a sweetmeat of wheat-flour.

सगपहिता *sagpūhita*,—see दलसग्गा *dalsagga*.

सतुआ *satua*, सतुई *satui*,—see सत्तू *sattu*.

सत्तू *sattu* or सतुषा *satua*, also (Shahabad) सतुरी *satui*, and (north, generally amongst mendicants) सितलबुकनी *sitalbukni*, parched gram ground into flour.

समोसा *samosa* also (Tirhut) परकिया *parakiya*,—balls of flour, with fruit, &c., inside, cooked in clarified butter.

सरबत *sarbat* (south-east),—sugar-cane juice mixed with milk ; also generally *cau suvé*.

सनि *sāni*,—see बोर *bor*.

साँस *sāns*,—a sweetmeat made of बेसन *besan* and molasses, eaten by boys in Patna.

सितलबुकनी *sitalbukni*,—see सत्तू *sattu*.

सिधा *sidha* or सीधा *sīdha*,—provisions, food, as in the proverb सिधा सन्देह, गयः गयः करथि *sidha sandeh, gabya gabya karathi*,—it is doubtful if he should get anything at all to eat from me, and he has the impudence to ask for milk.

सिरा *sira*,—see पाग *pāy*.

सिरुषा *sirua*,—soup.

सुरका चुरा *surka chūra*,—unripe paddy parched and pounded flat.

सुहारी *suhāri* (North-East Tirhut),—see पूरी *pūri*.

सूजी *sūji*,—the flour from the centre of the wheat grain.

सेव *seo* or (Shahabad) लकण्ठो *luktho*,—a kind of coarse macaroni, differing from सँवई *semwai* in not being regularly coiled.

सँवई *semwai*,—a kind of macaroni, which differs from सेव *seo* in being regularly coiled.

सँडा *saindha*,—see रिकौच *rikaunch*.

सोहारी *sohāri*,—see पूरी *pūri*.

सोन *son*,—see बोर *bor*.

हलुषा *halua*, also (Shahabad) काँची *kānchi*,—a sweetmeat made of flour, dried fruits, and clarified butter. Musalmāns also add eggs. A superior variety of this is known as महान भोग *mahan bhog*.

हानुस *hābus*,—green barley roasted as food.

होरन्हा *horha* (west), बोरन्हा *orha* (east generally), also होलन्हा *holha* (Patna and Gaya), बहुरी *bahuri* or परन्मल *parmal* (Shahabad),—unripe grain, roasted in the ear or pod.

होलन्हा *holha*,—see बोरन्हा *horha*.

DIVISION XII.

CEREMONIES AND SUPERSTITIONS OF RURAL LIFE.

CHAPTER I.—MARRIAGE.

1273. *Marriage* is amongst Hindus **बिवाह** *biyāh*, local optional names being **शुमङ्गली** *shumangali* (properly the marriage service described in § 1328) in North-West Tirhut and Champāran, and **बिवाह दानी** *biyāh dāni* in East Tirhut. **बिवाह** *biyāh* is common in North-East Tirhut, and **बिहा** *biha* in South Bhagalpur. Amongst Musalmāns it is **सादी** *sādi* or **शादी** *shādi*, **निकाह** *nikāh* being the less regular form. The marriage contract is **अकद** *akad* amongst Musalmāns.

1274. The *husband* is everywhere (amongst Hindus) **बर** *bar* (properly bridegroom), **भतार** *bhatār*, **पीया** *pīyā* or **पी** *pī* (only used in poetry), **पती** *patī* or **सामी** *sāmi*. Local terms are **जँवाय** *jañwāy* (properly son-in-law) (South-West Shahabad) and in East Tirhut **सैँरे** *saiñērē* amongst the lower classes and **सामी** *sāmī* or **सवामी** *savāmī* amongst the higher classes. **भतार** *bhatār* is sometimes specially used to signify a woman's second husband. Musalmāns use the word **शौहर** *shauhar*. The following words are used by Hindus and Musalmāns indifferently: **दुल्हा** *dulha* (properly bridegroom), **पुरुष** *purukh*, **मरद** *marad*, **खसम** *hasam*, **अदमी** *admi* or **अदिमी** *adimī** (also used in South Munger to mean wife), and **खाविन्द** *khāwind*. South of the Ganges occur **अमन्दी** *amndī* and **मरदावा** *mardāva*. A wife calls her husband **मरद** *marad*, or in the localities mentioned above **जँवाय** *jañwāy* or **मरदावा** *mardāva*. In South Bhagalpur she calls him **सँरे** *sāñērē*.

1275. A *wife* is **मेहरारू** *meharāru*, **इस्तिरी** *istiri*, **माउग** *māug* or **मौगी** *maugi*, **बहू** *bahū* or **बह** *bah*, (also, in Champāran, **बौह** *bauh*) (which means literally daughter-in-law), **जन्नी** *janñī*, **बेकत** *bekat* (also used to mean husband), **जनाना** *janāna*, **जोरू** *jorū*, and **कबिला** *kabila*, the last two

* Often spelt by purists **आदमी** *ādami*.

being principally used by Musalmāns. जीजी *jauji* (a corruption of *zauja*) is used only by Musalmāns and Kayasths. When talking to a respectable man about his wife, the word सवारी *savāri* or घर के लोग *ghar ke log* or a periphrasis is used. Thus they say in Shahabad अपने के सवारी ऐली हऱ *apne ke savāri āli ha?* 'has your wife come?'; रवाँ घर के लोग कहवाँ बाङ्गीँ *rawāñ ghar ke log kahvāñ bāṅgiñ?* 'where is your wife?'; or रवाँ हबेली में कब ऐली हऱ *rawāñ habeli mēñ kab āli ha?* 'when did your wife come?' lit. 'when did the being in your honour's inner apartments come?'

1276. When there are two wives, each is साउन *sāut* or सौतिन *sautin* to the other, a South Ganges variety being सोतिन *sotin*, and in South Munger सैतिन *saitin*. The first wife is बियाही *biyāhi*. In Patna and Gaya बिही *bihi*, and in Shahabad मेहरी *mehri* and कबिला *kubila*, are also used in the same sense. When there are two wives, the elder is called जठरी *jethri*, जठकी *jethki*, or बङ्की *barki*, and the younger लहुरी *lahuri* or हौटकी *chhotki*.

1277. A woman whose husband is alive is north of the Ganges प्रहवाती *ehvāti*, and south of the Ganges she is अहियाती *ahiyāti* or अहियाती *ahiyāti*. A local variety is ऐहब *aihab* in South-East Tirhut. सोहागिन *sohāgin* is another word used everywhere in the same sense. Another local word in South-East Tirhut is सधवा *sadhwa*. When a married woman is living in her father's house she is a नैहरैतिन *nāihraitin*, or in South Bhagalpur सवासिन *savāsīn*, and when she is living with her husband's family she is ससुरैतिन *sasuraitin*.

1278. A widower is रण्डा *rānda* or राँड़ा *rāñra*. If he marries a second time he is दोआह *doāh* or (in East Tirhut) दुतिबर *duṭibar* or दुबियाहा *duibiyāha*, and in South Bhagalpur दोबिहा *dobiha*. If he marries a third time he is तैआह *teāh* or (in East Tirhut) त्रितिबर *tritibar*, and South Bhagalpur तेबिहा *tebiha*. In such case he is also called दोआह *doāh*.

1279. A widow is बेवा *bēva* or राँड़ *rāñr*. Another term is बिधवा *bidhwa*. In South-East Tirhut बैधब *baidhab* is also used. The second marriage of a Hindu widow is सगाइ *sagāi*. Optional names are सगहन *sagaham*, सम्बन्ध *sambandh* or समध *samadh*, used chiefly north of the Ganges. To the south-east चुमावन *chumāvan* or चुमौना *chumauna* is also used in this sense. Such a woman is called to the west अरधी *ardhī*, and the second husband is सगङ्गा *sagāgha* or सँगङ्गा *sāñghua*. In Western Shahabad he is साँघुत *sāñghut*, and to the west generally

रन्धुचा *ardhua* or भतार *bhatār*. A child brought forth by the widow previous to the ceremony is पङ्गलग्वा *pachhlagwa* or कठन्बेटा *kathbeta*, in South Bhagalpur लहन्बेटा *lahbeta*. The second marriage of a Musalmān widow is अकद सानी *akad sāni* or निकाह *nikāh*.

1280. A *kept-woman*, who lives with a man without marriage, रखेलिन *rakhelin*, रखेली *rakheli*, or रखन्नी *rakhni*. Other names are री *rāndi*, उद्दी *urharhi* or उदरी *urhari*, and डेमनी *dhemni*. सुरैतिन *waitin* is used in South-West Shahabad.

1281. The *bridegroom* is दुल्लाचा *dullha*, बर *bar*, नौसे *nause* or नौशे *nause*. Also, south of the Ganges, गभरू *gabhrū*. In East Tirhut the forms बिखिया *bikhiya* and बिखेया *bikheya* are current. The bride's people call the bridegroom लरिका *larika* or बेट्वा *betwa*.

1282. The *bride* is दुल्लहिनि *dulhin* or कनैषाँ *kanañ*, also in South Bhagalpur कन्याइन *kanyāin*. The bridegroom's people call her लरिकी *lariki*, लरकिनी *larkini*, or बेटिया *betiya*.

1283. The *dowry* is जहेज *jahej* or दहेज *dahej*. In South-East Tirhut it is जैतुक *jaituk*.

1284. The *marriage settlement* amongst Musalmāns is मोहर *mohar* den north, and दैन महर *dain mahar* south of the Ganges.

CHAPTER II.—WEDDING CEREMONIES GENERALLY.

1285. The *proposal* for a boy in marriage by the girl's relations *vice versa* is amongst Hindus बरन्तूद *bartūi* or बरन्देखी *bardekhi*, in Shahabad बरेखि *barekhi*. In South Munger it is sometimes पनन्बट्टी *mlatti*. In Patna it is occasionally बभन पुच्छी *babhan puchehhi*. Amongst Musalmāns the name for a proposal is निस्बत *nisbat*.

1286. The *match-maker*, who conducts the preliminary negotiations, is everywhere अगुआ *agua*. In North and East Tirhut he is also टक *ghatak*. The barber and Brāhman, who are messengers, and sometimes negotiators, in the matter, are called collectively नौआ ब्राह्मन *na brāhman*. The searching for a boy in marriage is north of the Ganges, to the west, लरिका खोज *larika khōj*, in South-Tirhut बरन्तूदारी *bartuhāri* or सुधावधा करब *sudhābadha karab*, while in North-east Tirhut it is कथा करब *katha karab*. South of the Ganges it is बरन्तूदार *bartuhār*. Most of these words, however, include the

preliminary negotiations, when a suitable boy has been found. If, during the negotiations, a member of the bride's house visits the bridegroom's, or *vice versa*, the food given him to eat is called बरतूही के भात *bartūhi ke bhāt*. The first food given to him after the marriage under similar circumstances is भथखै *bhathkhai*.

1287. The *betrothal* consists in paying the तिलक *tilak* on the occasion of the formal proposal and acceptance of the proposal of marriage. This तिलक *tilak* is a present made to the bridegroom's people by the bride's people in the bridegroom's house. Some castes pay a portion of this in advance, as a sort of retaining-fee to secure the bridegroom; and when this is done, it is called फलदान *phaldān*, छँका *chhenka*, or बर छँका *bar chhenka*. In Sāran and Champāran it is also called बरचा *barachcha*, in South-East Tirhut पनचही *pancharhi*, and in South Bhagalpur पनटोही *pantohi*.

1288. The man who carries the छँका *chhenka* is the छँकहनू *chenkāhru* north of the Ganges. South of the Ganges he is छँकहनरी *chhenkāhri*, or in South Munger महन्तों *mahton*.

1289. The *period of marriage ceremonies* dates from the presenting of the तिलक *tilak*, and is called लगन *lagan*, or in East Tirhut सुध *sudh*.

1290. The *marriage procession* is बरियात *bariyāt*. Sometimes the Hindi form बरान *barāt* is used. When it remains at the house of the bride a day after the wedding, the halt is called मरजाद *marjād*. When a bride's father is unable through poverty to defray the expenses of the marriage, and he sends her to the bridegroom's house for the performance of the ceremony, she is called कदुई *karhui*, कदुआ *karhua*, or डोल कदुई *dol karhui*. The marriage procession is the first formal visit of the bridegroom to the bride's house.

1291. The second visit, which consists in the ceremony of going to the bride and bringing her home to her husband's house for the consummation of the marriage, is गवना *gawna*, गवन *gawan*, or गौना *gauna*. In East Tirhut it is also दुरागमन *durāgaman*, and south of the Ganges दुरागौन *durāgaun*. Another name is रोकसती *roksati*, रोकसही *roksaddi*, रोसकती *roskati*, or रोसकही *roskaddi* (رخسني). Yet another is बिदागी *bidāgi*.

1292. If the bridegroom pays an intermediate visit, it is called in South-East Tirhut दुरागन्नघन *durāgnaghan*. Immediately

before the final visit to fetch the bride, a message is sent to the bride's house with some presents, to announce the approaching of the time for the visit. The presents are called नेचार *neār*, and the persons who carry them नेचरधरया *neardharua*. The persons who actually fetch the bride are लौताहर *lautāhar*, नेवन्तहर *neotahar*, लेंताहर *letāhar*, or चावन *liāwan*, or in South Bhagalpur लेयारी *leyāri*.

1293. The *newly-arrived bride* is called गौनहरी *gaunahri*. In East Tirhut she is also called बड्यासिन *bahuāsīn*. The male members of her party are लोकनाहा *loknāha*, and the females लोकनी *lokni* or कनिया *lokaniya*.

1294. After consummation of marriage, *the first and second visits to the bride to her parents' house* are called रोकन्ती *roksati*, &c., as above. The second *visit of the bride to her husband's house* is दौंगा *dainga*, and her third visit is तेंगा *tenga*. Her subsequent visits to her husband's or her parents' house are called रोकन्ती *roksati*, दागी *bidāgi*, बिदागरी *bidāgri*, अवन गवन *awan gawan*, अहुरा *ahura bahura*, अहोर बहोर *ahor bahor*, औरा बौरा *aura laura*, or दल गैल *āil gail*.

1295. A *married girl in her father's house* is called by her people दाई *daī*, धी *dhi*, बबुई *babuī*, or सुआसिन *suāsīn*. When a wife is in her father's house, and her husband wishes her to return, he sends a messenger (generally a barber by caste) to summon her, who is called पथनिया *pethvaniya*.

1296. Their *father-in-law's houses* are called by bride and bridegroom respectively ससुरार *sasurār*. The educated also use the Hindi word ससुराल *sasurāl*. In East Tirhut it is called सासुर *sāsūr*, and in Allahabad sometimes ससुरा *sasura*.*

1297. The *wife's parents' house* is called by her in Patna and Mith Munger नहिरा *nahira* or मैका *maika*, and in South Bhagalpur नेहरा *nehra*. Elsewhere she calls it नैहर *naihar*.

1298. The *husband's or wife's maternal grandmother's house* is called by him or her नानौहाल *nānihāl*, ननिहाल *nan.hāl*, ननिहार *nanihār*, नहर *nanihar*, or ननिऔरा *naniāura*. Other names are ममन्हर *manhar*, मल (in East Tirhut) मात्रिक *mātrik*.

1299. The *husband's or wife's paternal grandmother's house* is called by her दादौहाल *dādihāl*, ददिहाल *dudihāl*, ददिहार *dadihār*, ददिहर

* A man in his father-in-law's house is always made much of, and fed well ; hence in thieves' jargon a jail is called (let us hope sarcastically) ससुरार *sasurār*.

dadihar, or ददिशौरा *dadiaura*. Another name current in East Tirhut is पैत्रिक *patrik*, while in South Bhagalpur they say बपहर *baphar*.

1300. Their *maternal uncle's houses* are his or her ममहर *mamhar* or ममुहर *mamuhar*. So also the *paternal uncle's house* is ससुरार *sasurār*.

1301. The *paternal grandfather's house* is (north of the Ganges) अजिशौरा *ajiaura*.

1302. The *father of the bride and the father of the bridegroom* call each other समन्धी *samdhi*. Their wives call each other समन्धिन *samdhin*.

CHAPTER III.—SPECIAL WEDDING CEREMONIES AMONGST THE HINDUS.

1303. Marriage ceremonies vary somewhat according to locality and caste. The following is mainly a description of such a wedding as might take place in the house of a well-to-do goāla in Patna, see § 1353. When the marriage has been agreed upon, the father of the bridegroom visits the father of the bride, and each provides a few hand-fuls of paddy (धान *dhān*). These are mixed together, and then divided between the two fathers by a Brāhman, and the bridegroom's father takes his share home. This ceremony is called धनबट्टी *dhanbatti*. This paddy is reserved to be parched in the *chūlha* which will be subsequently mentioned.

1304. Then the females of the bride's family perform the चुमावन *chumāvan* or चुमौना *chumanna* ceremony. In this five women take rice between the thumbs and forefingers of both hands and touch in order her feet, knees, and shoulders with it. They then put it on her head. To perform this ceremony is चुमाएब *chumāēb*.

1305. On the fifth or eighth day before the expected arrival of the wedding procession, the following preparations are made in the bride's house. If they take place five days previously, they are called पचमंगरा *pachmangra*; if eight days, अठमंगरा *athmangra*.

1306. The ceremony called मटकोड़वा *matkorwa*.—The women of the family, and their friends, go singing to a well. They level a piece of ground near the well and smooth it down with लाल माटी *lāl māti*, a kind of yellow clay which is generally found immediately over gravel. They then dig a clod up out of it, and carry it home on the head of one of them. They make a

re-
place, **चूल्हा** *chūlha*, of this mud in the centre of the court-yard
• **आँगन** *āngan*. In South Bhagalpur they set up a plantain-tree and a
umboo in the courtyard, under which they place the mud.

1307. The day before the expected arrival of the marriage proces-
sion, the family sets up a bamboo shed in the court-yard over the
re-
place. This shed is called **मढ़वा** *marhwa*, **मँड़वा** *manrwa*, or **माँड़ो**
āuro, also in South Munger **मड़ही** *marhi*, and in South Bhagalpur **मण्डप**
mandap. The same day a potter brings an earthen pot, called **कलसा**
ksa, with a four-wicked lamp, called **चौमुख** *chaumukh*, on its top. This
placed in the house where the family god is placed for the purposes
the marriage. This house is called **कोहबर** *kohbar*. According to
me the pot is placed at once in the **मढ़वा** *marhwa*.

1308. A plough-shaft (**हरिस** *haris*), a plough-yoke (**पालो** *pālo*),
and some bamboo twigs (**करन्ची** *karchi*), are then buried in the ground in
the centre of the **मढ़वा** *marhwa*. Then five men bring out from the
कोहबर *kohbar* the **कलसा** *ksa*, and place it under the **मढ़वा** *marhwa*
front of the bamboo twigs. The father of the bride then anoints
the four posts of the **मढ़वा** *marhwa* with **घ्यू** *ghyu* (clarified butter), and on
which the mother applies some vermilion (**सेनुर** *senur*). The name of
this ceremony is **घ्यूहारी** *ghyudhāri* or **ढीहारी** *dhūdhāri*. In South
Bhagalpur it is **घिहारी** *ghihāri*. At the same time worship is offered
to the progenitors of the family, which is called **मन्त्रीपूजा** *mantri*
ia. Then five men take turmeric (**हरन्दी** *hardi*), oil (**तेल** *tel*), and
b grass (**दूबी** *dūbi*), which they scatter on the bride's forehead. This
is called **हरन्दी चहाप्रब** *hardi charhāch*. Then women anoint her body
with oil and turmeric. This is called **उबटन** *ubtan*, &c.; see § 1342.

1309. Next day, before the arrival of the procession, the paddy
seed from the **धनबट्टी** *dhanbatti* is parched in the fireplace under the
मढ़वा *marhwa*. This is prepared for the ceremony of **खावा छिटार**
khāva chhitāi (see § 1332), at the time of the marriage circumambula-
tion. The fireplace is then put to one side.

1310. Next follows the ceremony of *swallowing the mango fibre*.
This is called **इमन्ली घोंटार** *imlī ghontāi*. In South Bhagalpur a similar
ceremony is called **अमन्लो घोटन** *amlo ghotan*. An elder male of the
bride's family (usually her brother) puts into her left hand a present
of money or ornaments. The barber's wife then gives him the
fibre of one of the mango leaves hanging up in the
मढ़वा *marhwa*, which he presents to the mother's mouth. The mother
then bites a small piece off this and deposits it in the hollow

of her own right hand, into which the elder male pours a little water. The piece of fibre is called खरिका *kharika*, तिनका *tinka*—, or दण्टी *danti*. This the mother holds over her daughter's head and gulps (घोंटव *ghontab*, to gulp) it all down. The elder male then says to her, "Art thou cool (*i.e.*, pleased)? (खड़ेखू *jurailū*)," to which she replies "I am cool (खड़ेखी *jurailū*)."

1311. Wedding wreaths of mango leaves, flowers, &c., are hung over the door, and about the महन्वा *marhwa*. These are, north of the Ganges, बन्दनवार *bandnecār* or बनवार *banecār*. South of the Ganges they are बन्दनवार *bandanecār*, and in South Munger घेरा *ghera*. In South Bhagalpur mango branches are hung about the house, and are called पल्लो *pallo*.

1312. In the bridegroom's house, before the marriage procession starts for the marriage ceremony, very similar ceremonies are gone through; the मटकोड़वा *matkorwa* is performed. A चूल्हा *chūlha* is made in the court-yard. The plough-shaft, yoke, and bamboo twigs are buried, and the earthen pot with lights is set up. Only no महन्वा *marhwa* is built. The ceremonies of चुमौना *chumanna* and चरन्दी चढ़ाप्रब *hardi charhāeb* are performed on him, as is done to the bride.

1313. The paddy reserved from the धानबट्टी *dhanbatti* is parched in the चूल्हा *chūlha*. This parched grain is taken with the wedding procession, and mixed with that parched in the bride's house, and with it scattered at the circumambulation (§ 1332).

1314. They then cover him with cosmetic (उबनउब *ubtan*, &c., see § 1342), and his nails are cut by a barber's wife, he sitting in front of his mother, and his mother wearing the *maur* (see § 1326). This, as in the bride's case, is called नहखू *nahchhu* (see § 1326). The ceremony of इमन्ली घोंटाइ *imlī ghōṭāi* is also observed (see § 1310).

1315. He is then bathed and anointed, and sets out with the marriage procession. A little of the water in which he was bathed is brought with him. This is called सिनेह के पानि *sinēh ke pāni*. He is not allowed to bathe again until the चौथारी *chauthāri* (see § 1340). When the marriage party arrives at the bride's house, this water is given to her mother, and at the time of the girl's नहखू *nahchhu*, the barber's wife will mix it with other water, and bathe the bride with it immediately before cutting her nails.

1316. *The first scattering of rice.*—When the bridegroom arrives at the door of the bride's house, the women of her family receive him,

and scatter over him uncooked rice, the dung of a heifer, balls of cooked rice, and other articles. A married woman of the family then takes a brass pan (झीपी *chhipi* or थारी *thāri*) and a small lamp (दीया *dīya*) and gives them to the bridegroom; and then, holding two corners of her mantle (चुनरी *chunri*), touches with them the pan, then the boy's forehead, and then her own. This is called परिचावन *parichāvan*, परिचन *parichhan*, परञ्चावन *parchhāvan*, परञ्चन *parchhan*, or परञ्चौनी *parchhāni*. A similar ceremony is called in South Bhagalpur गलसेदी *galseđi*.

1317. *The ceremony of the pestle.*—The girl's mother then rubs in the palm of her hand a curry pestle (लोढ़ा *lorha*), which she applies to the cheeks of the bridegroom. This is called गाल सँकी *gāl senki*. This custom is not known in South Bhagalpur. Instead there is performed a ceremony called धूआ *dhūa*. A man disguises himself as a woman and approaches the wedding party with a jar of water. He says he is a woman of Kāmrup (Assam) come to give away the bride. He then sprinkles water on the bridegroom. (Compare § 1320.)

1318. *The marking of the bridegroom's forehead* with sandal paste before marriage is तिलक *tilak* or तिलक *tilak*. In South Bhagalpur it is चन्दन *chandana*. This is done by a man called in the west तिलकहारू *tilkaharu*, and in the east तिलकदेउआ *tilakdeua* or तिलकिया *tilkiya*. He is generally the bride's father. This *tilak* is quite distinct from the *tilak* paid at the time of proposal of marriage.

1319. These ceremonies at the door are called collectively दुआर पूजा *duār pūja*. In South Bhagalpur they are known as दुआर लगार *duār lagār*. Those described above are those performed by goālas in Patna. Other castes have other customs,—the higher ones contenting themselves with giving presents to the bridegroom and scattering rice (अच्छत *achchhat*) over him.

1320. The wedding procession then proceeds to put up in a place set apart for them. This is called जनवाँसा *janwānsa* or (in North-East Tirhut) बैठकी *baithki* or बासघर *bāsghar*, and in South Bhagalpur जनमाथा *janmāsa*. A male member of the bride's family (generally her sister's husband) then brings to the जनवाँसा *janwānsa* a bowl of sweet drink or *sharbat*, called धूआ *dhūa*, and covered with a red cloth. He also brings some urid (*dolichos pilosus*) flour mixed up with finely-powdered pepper. This is called बुकआ *bukua*. On his arrival at the जनवाँसा *janwānsa* he scatters this in the air, causing the bridegroom's party to sneeze. He then gives all those

present to drink of the *sharbat*. The whole ceremony is called बुकुआ चढ़ाई *bukua urāi*. A similar ceremony is called, north of the Ganges, धुरच्छक *dhurchhak*, in which water is sent in pitchers, and a little scattered over the party with mango sprays.

1321. The barber now comes for the bridegroom's मौर *maur* or head-dress, as will be subsequently described, which he takes away to the bride's house.

1322. When all is ready the friends of the bridegroom leave the जानवॉसा *janvāsa* with great pomp, carrying with them the presents for the bride. Amongst these is a valuable cloth, called कनसाई *kaneāi*, or in South Bhagalpur बिचौती *bihauti*, which is taken to the female apartments, and in which she is dressed. She is then brought out and made to sit in the महंगा *marhwa*. This visit is called निरिच्छन *nirichchhan*, निरच्छन *nirachchhan*, or निरन्हन *nirehhan*, as the bridegroom's party see (निरेखन *nirekhab*, to see) the bride now for the first time.

1323. Then the ceremony of *making the bracelet* is performed. The bridegroom and seven other men husk paddy in a mortar. When husked, two or three grains are wrapped up in mango leaves to form a kind of bracelet. Two of these bracelets are made, and one is tied on to the bridegroom's right wrist, and the other on the bride's left wrist, by a Brāhman. These bracelets are called कङ्गन *kangan* or कङ्कन *kankan*. The ceremony is called अठौंगर *athongar*, अठौंगर *athaungar*, or (in Patna) लठौंगर *lathaungar*.

1324. Then follows the *adoration of the bride*. In this ceremony the elder brother of the bridegroom (or in default of him some elder of the bridegroom's family) offers sweetmeats, molasses (गूर *gūr*), and ornaments to the bride. He then takes some betel-leaf and tyre (दही *dahi*) in his right hand, and presses it against the bride's forehead, at the same time pressing his left hand against the back of her head.

1325. These two ceremonies are together called बन्दन *bandan*, गुरन्हत्ती *gurhatthi*, or गुरन्हत्तन *gurhatthan*, and signify that he has touched her once for all, and that, if he touch her again he will be guilty of a sin. In South Bhagalpur they are performed by the bride's sister, and both bride and bridegroom are adored. There the ceremonies are called गुरौंघा *guraundha*.

1326. Then the bride's mother sits in the महंगा *marhwa* with the bride between her knees, holding her round the waist. The cere-

mony that follows is the *cutting of the nails*. This is called नहच्छु *nahchhu*, नहच्छुषा *nahchhuṣā*, नहच्छुषा नहावन *nahchhuṣā nahāvan*, नहच्छुषा *nahchhuṣā*, or (in Shahabad) नहच्छुङ्गी *nahchhuṅgī*. In South Munger it is नहच्छुषा *nahchhuṣā*, and in South Bhagalpur लौच्छुषा *lauchhuṣā*. The bride's mother has previously sent (§ 1321) a barber (हजाम *hajām*) to the जनवाँसा *janwāṣā* to ask for the head-dresses. There are two head-dresses,—one worn by the bridegroom, which is made of talipot-leaves and is called मौर *maur*; the other is worn by the bride, and is called मौरी *mauri*, or (south of the Ganges) पटव्वासी *patwāsi*, or पटमौरी *patmauri*. The bride's head-dress is made of date-leaves. The barber brings these two to the bride's house and puts the मौर *maur* on the mother's head and the मौरी *mauri* on the bride's head. Then the barber's wife (हजामिन *hajāmin*) cuts the finger and toe-nails of both the bride and her mother (the bridegroom's having been cut before he left home).

1327. The bridegroom's party then returns to the जनवाँसा *janwāṣā*, and the bride goes inside the house and exchanges her कनेआइ *kaneāi* for her wedding dress or पिचुरी *pūiri* (see § 1348). The bridegroom is then sent for and is seated under the महवा *marhwa*, and the father or elder male relation brings the bride and seats her beside the bridegroom under the महवा *marhwa*, to his left. Some one belonging to the bride's family then goes inside and gets the bridegroom's *maur* from the bride's mother, and brings it out, and it is put on the bridegroom's head.

1328. Then the *marriage service* is read by the Brāhman. This is called शुमङ्गली *shumangali* or सुमङ्गली *sumangali*. The bridegroom sits under the महवा *marhwa* in front of the bride. The father of the bride sits kneeling on one knee, keeping the bride sitting on his other thigh. This is the ceremony of giving the girl in marriage, and is called कनेआँ दान *kaneāñ dān* or जाँघा (जाँघ or जाँघिया) बैसाप्रब *jāngha* (*jāngh* or *janghiya*) *baisāṣb*.

1329. It is not necessary to describe particularly the procedure carried out by the officiating Brāhman. He recites (or is supposed to recite) verses from the Vedas, and leads in various acts of worship, such as throwing incense on the fire, throwing rice (अच्छत *achchhat*) about, worshipping Gauri, and the like. At one period the Brāhman puts into the bride's father's hand a shell containing water, flower, *achchhat*, and metal, and makes him empty it round the base of the earthen pot कलसा *kalsā* on the top of which the lamp with four lights (called

चौमुख *chaumukh*) is burning. He makes him do this five or seven times. This completes the ceremony of कनेचाँ दान *kaneāñ dān*.

1330. From the time of the arrival of the बरियान *bariyāt* up to the completion of the कनेचाँ दान *kaneāñ dān*, the father and mother of the bride can eat nothing.

1331. Next follows the *knotting together of the clothes of the bride and bridegroom*. This is गेंठ बन्धन *genth bandhan* generally. South of the Ganges it is sometimes known as गेंठ जोड़ु *genth jor* or गेंठजोड़न *gethjoran*, and in South Bhagalpur as जनम गेंठ *janam genth*. At the same time something of small value, such as a two-āna piece or a few pice, or sometimes a piece of betel-nut, is tied in the bride's waist-band and in her breast-cloth by the Brāhman. Sometimes an ornament is tied to the bride's sheet, which is called अँचन्री पालो (or पल्लो) *añchri pālo* (or *pallo*).

1332. The *circumambulation of the sacrificial fire*.—This is sometimes done by both bride and bridegroom, sometimes, *e.g.* in North-West Tirhut, by the bridegroom alone. They or he carry a winnowing sieve. The bride holds it in her hands in front of her, and the bridegroom follows her with an arm passing round her on each side, also supporting the sieve. Her brother fills the sieve as they go along with parched grain prepared in the fireplace formerly under the मढ़वा *maḍwa*, which the bridegroom at the same time scatters by shaking the sieve with his hands (this is called लावा छिटाइ *lāwa chhitāi* or, in Shahabad, लावा मिराइब *lāwa mirāib*). Care is taken to keep the sacrificial fire (when there is one) or the altar to the right.* It is considered unlucky for the girl to pass it to her left. This ceremony is called भाँवर *bhāuvar*, भाँवरी *bhāuvari*, भौँरी *bhauūri*, or सत भौँरी *sat bhauūri*. It is also called बैँदि घुमाएब *bedi ghumāēb*. This circumambulation is performed five times, and is the important part of the ceremony. The couple on its conclusion are *fumigated with incense* by the officiating Brāhman. This is called आरन *ārat*, आरन्ती *ārti*, अगन्ती *agti*, or अगियासी *agiyāsi*. In South Bhagalpur it is called होम *hom*.

1333. When this is done, the bride's sisters and her brothers' wives amuse themselves by pushing the bridegroom about, and lifting him up by the ears. This last is supposed to be done five times, but

* The reverse rule is observed by some castes when the horoscope makes out that it is necessary.

is rarely done more than once. It will be seen that this is only done by females. Amongst the Tirhutiya Brāhmins and Kāyasths, however, it is done by the bride's brother. The ceremony is called बरक बैसाप्रब चडाप्रब *barak baisāṅb ulhāṅb*.

1334. This is followed by the *application of vermilion*. In this the bridegroom takes a small cup containing vermilion in one hand, and applies vermilion to the parting of the bride's hair with a piece of homp. This is called सेनुर दान *senur dān* or सिन्दुर दान *sindur dān*.

1335. *The stopping at the door.*—The couple then leave the courtyard and go into the house where the family deity is put. This house is called कोचबर *kohbar*, or in South Bhagalpur कोचबरा *kohbara*. At the door they are stopped by the sister of the bride, who requires the bridegroom to repeat certain verses, called दुरौध *duraudh* or दुरौधा *duraudha*. The bridegroom demands a present for doing so, and on this being given he repeats the verses. This ceremony is called दुआर हँकार *duār chheṅkai* or दुआर हँकौनी *duār chheṅkauni*.

1336. *The stealing of the shoes.*—The bridegroom takes off his shoes before entering the house. If he is silent or is too nervous to speak much, the bride's sister may, as a joke, steal his shoes while he is inside, and conceal them somewhere, in order to compel him on his reappearance to speak, and say "where are my shoes?" This ceremony is called जूता चोराइ *jūta chorai*. In South Bhagalpur they make the bridegroom bow to a pair of shoes covered with cloth, and the ceremony is called जूता गोर लगाइ *jūta gor lagai*.

1337. The couple then kneel facing the north-east, and perform the *worship of the tutelary deity of the family*, offerings being made to him at the same time. This is called गोर लगाप्रब *gor lagāṅb*. The clothes of the bride and bridegroom are then untied, the promised presents given to the sister of the bridegroom, and the marriage is concluded, the bridegroom returning to the जनवाँसा *janwāsa*, and the bride remaining in the house.

1338. Shortly after the marriage, though this sometimes takes place the morning after, the bridegroom goes to his mother-in-law, who feeds him with rice-milk. After eating a little he sometimes takes the rest, dish and all, to the जनवाँसा *janwāsa*, and finishes it there, or sometimes leaves it unfinished. This is called खीर खियाव *khīr khiyāo* or बियाही भान *biyāhi bhāt*, or (in East Tirhut) महुअक *mahuak*.

1339. If the bride's people invite the bridegroom's people to stay over the night, it is called मरजाद राख *marjād rākh*. This may last

for two or three days or more. On the expiry of the period of *मरजाद marjād*, the bride's people see the bridegroom's party off. This is called *रोस्कति करि देब rosukti kari dēb*, &c., as in § 1291. In South Bhagalpur it is also called *लोठली lotli*. It is managed as follows: The bride's family collects in the court-yard all the presents received from the bridegroom's party, and with the assistance of village friends assesses their value. All this time the bridegroom's party is away in the *जनवाँसा janwāṅsa*. When the value has been assessed, the bride's father collects on his side presents to the value of at least one-fourth greater value than those received, and takes them to the *जनवाँसा janwāṅsa*. These return presents constitute the dowry, and are called the *दहेज dahej*. The bride's father lays them before the bridegroom's. Then the bridegroom's father takes a new cloth (*चदर chaddar*) and puts it on the bride's father. The bride's father in return presents the bridegroom's father with a purse of money of the value of the *chaddar*. Then both *salām* to each other. Then the bride's father, in token of allowing the other to depart, presents him with a sum of money varying according to means, and a *lota* of water, saying "राम राम *rām rām*," to which the other replies in the same words. This ceremony is called *रामराम्मी ramrammī*, *मौलन milan*, *मिलनी milni*, or *समन्धी मिलावा samdhī milāva*. The two fathers are now, by relation, *समन्धी samdhī* to each other, and in token thereof they exchange cloaks and garlands. These exchanged cloaks and garlands are called *समन्धो samdho*. Amongst lower castes, as the procession is about to start, the bride's father gives each member money sufficient for the way expenses and drink, called *बटवारी batsāri*, and in South Bhagalpur *पाथक pāthak*. Then the procession, bridegroom and all, goes off.

1340. *The untying of the bracelets.*—Four days after the marriage the bride and bridegroom bathe, and the bracelets on their two wrists are taken off. This ceremony is called *चौधारी* or *चौडारी chauthāri* or *चतुरन्धी chaturthī*. This is the first washing the bridegroom and bride get from the time of the arrival of the procession before the marriage. During the interval they have been anointed with cosmetics, *उबटन ubtan*, &c.; see § 1342. Usually this is done in their respective houses, but in Patna the bridegroom sometimes goes to the bride's house to perform the ceremony. This concludes the marriage proceedings.

1341. *Miscellaneous.*—The *wedding breakfast* is (north of the Ganges) *कलौ kalau* or *मजनी majhni*. South of the Ganges, in Shahabad it is *पङ्कन panghat*, and elsewhere *गोरौधा goraudha* or *गुरौधा guraudha*.

The feast at the houses of both parties the day before the marriage procession is *भतव्वान* *bhatwān*, *भतव्वानी* *bhatwāni*, or *भोज* *bhoj*. Before eating the guests wash their feet, and the ceremony is called *पर पखारी* *pair pakhāri*, *पैर पखरवा* *pair pakharua*, *पाँव पखारी* *pāñw pakhāri*, *गोड़ धोड़* *gor dhōi*, or *गोड़धोआर* *gordhoāi*.

1342. The *cosmetic* of turmeric, meal, oil, &c., rubbed on the bride and bridegroom for about ten days before marriage, is north of the Ganges *अबन्टन* *abtan*, and in East Tirhut *उगन्टन* *ugtan*, *कसूर* *kasār*, or *कासा* *kāsa*. South of the Ganges we find *उबन्टन* *ubtan* or (in Patna) *ओबन्टन* *obtan* very generally used; also *आँवट* *āñwat* and *अपटन* *aptan* in Shahabad, *उकन्टन* *uktan* in South Munger, and *कासा* *kāsa*, *वसारा* *kasāra*, or *उटकन* *utkan* in South Bhagalpur.

1343. The *horoscopes* of the boy and girl are everywhere *जनम पत्र* *janam patr* or *जनम पत्ररी* *janam patri*. Also, very generally, *टीपन* *tipan*. In West Shahabad they are also *कुण्डली* *kundli*. If they agree, the phrase *गनना बनब* *ganna banab*, or *जोग मिलाब* *jog milab*, or *रास बरग बैस गेल* *rās barag bais gel*, is used. To calculate the horoscope is *गिनब* *ginab*, or *जोग मिलाप्रब* *jog milāprab*, or *दिन गुन्नी करब* *din gunni karab*, or *बभन पुच्छी* *babhan puchhī*.

1344. When the auspicious day for the marriage has been fixed, an *announcing letter* is sent to the bridegroom's father. This is known as the *लगन पत्री* *lagan patri*, or simply as the *चिट्ठी* *chitthī*. The *formal invitation* to the wedding is *नेवन्ता* *neñcta* or *नेवन्ता* *neota*, or (in East Tirhut) *नवत* *navat*.

1345. The *feast given to the brotherhood at the wedding* is known as *भद्वारा* *bhaiāra*, *भद्वारी* *bhaiāri*, *भद्वारे* *bhaiāre*, *भद्वारो* *bhaiāchāro* (Shahabad), *जेवन्नार* *jeonār*, or *भोज* *bhoj*.

1346. In North-East Tirhut, amongst certain castes, especially the *Bikau* (बिकौआ) Brahmans, *caste money* is paid as follows. If the bride's father is of lower caste than the bridegroom's father, the latter pays the former a sum in compensation called *कनेआँ दान* *kaneāñ dān*. In South Bhagalpur this is called *मैन* *main*. If the bridegroom's father is of lower caste, he pays the bride's father a sum of money called *बिकरी* *bikri*.

1347. The *presents* given are as follows:—*सनेस* *sanēs*, *डाला* *dāla*, or *डाल दौरा* *dāl दौरा*, are the presents sent by the bridegroom before the arrival of the procession. *दहेज* *dahēj*, as already explained, is the dowry paid by the bride's father. Before the bridegroom leaves after the wedding, he goes to bid his mother-in-law good-bye. She

and the other women give him presents, which are called *सलामी salāmi*. Other similar presents are in South Munger पुरन *pūran*, and in South Bhagalpur चौक *chaunk*. निहावर *nichhāvar*, निहाउर *nichhāūr*, or नेवन्हावर *neochhāvar*, are presents made to the barber and his wife. गैदान *gaidān* or गौदान *gaudān* is the present of a cow made by the girl's father to the family priest (परोहित *parohit*, or (in East Tirhut) पुरोहित *purohit* or अचार्य *achāry*). गुरहत्थी *gurhatthi* has already been mentioned as the ceremony of giving presents to the bride by the bridegroom's elder brother (§ 1325). मोहदेखार *mohdekhāi*, मुदेखौनी *mudekhauni*, or मुदेखी *mudekhī*, are the presents given to the bride by her mother-in-law or other female relatives of the bridegroom on her first coming to her husband's house.

1348. The पिचरी *piāri*, पीरी *pīri*, or (in South Bhagalpur) कनियेती *kaniāiti*, is the bride's yellow dress, and कन्हावर *kanhāvar* or कंधावर *kandhāvar* is a red loin-cloth laid upon the bridegroom's shoulder during the ceremony.

1349. *Bringing the bride home.*—This is गौना *gauna*, &c., vide § 1291. The procedure is as follows:—When the bride is old enough to live with her husband, an auspicious day is fixed. Some days before the date, the bridegroom's family send a present of sweetmeats, called गौना के नेचारा *gauna ke neāra*. On the evening of the appointed day the bridegroom and his party arrive, and after feasting go off with the bride at dawn next day. The day before, a plough-shaft (हरिस *haris*), but no yoke or bamboo twigs, has been buried in the court-yards of each of the respective families. Before the bride and bridegroom start, their nails are cut. This is called नह छहार *nah chhahār* or नोह छिलार *noh chhilāi*. With the party the bride's people send one or more gaily-decorated earthen vessels full of sweetmeats, called कुण्डा *kunda* or महार *mahar*.

1350. When the party arrives at the bridegroom's house, the bride passes from the litter to the door, putting her feet into a basket at each step. This is called दौरा में गोर डारब *daura meñ gor dārab* or घर पैसारी *ghar paisāri*.

1351. On entering the dwelling the couple go into the house where the family god is, and worship him. This is called गोर लगारब *gor lagārb*.

1352. As they go into the house, another ceremony, called दुआर *duār* or छेनकै *chhenkai*, is performed. In this the bridegroom's sister

demands a present, and when it is given or promised she allows them to pass.

1353. *On certain ceremonies performed by Soti Brahmans of East Tirhut.*—Different castes and different localities have various marriage customs, but the one just described may fairly be taken as a standard Hindu marriage ceremony. It describes a marriage such as would take place in a well-to-do goāla's house in the district of Patna.

1354. The Soti Brāhmans of East Tirhut have several curious marriage customs which have existed for many hundred years, some of which will now be noted. The greatest care is kept in keeping up correct genealogies of members of this clan. The genealogical registers are called पाँजी *pāñji*, and they are kept up by hereditary genealogists called पैजियार *pañjiyār*. Once a year or oftener there are great meetings of these Brāhmans at Saurāth, near Madhubani, and other places, where the *pañjiyārs* assemble and write up the registers. They also arrange marriages after consulting their registers, and give certificates to the parents certifying that the marriage is lawful, and that the parties are not within prohibited degrees of affinity. These certificates are called अधिकार माला *adhikār māla* or असुजन पत्र *asujin patr*. The settlement of the conditions of marriage is called सिधँत *sihānt*.

1355. When the bride is of equal or higher caste than the bridegroom, the parties meet in a distant place away from both their homes, and the conditions are proclaimed by the *pañjiyārs* present. If, however, the bride is of lower caste, the following procedure is adopted:—

The bride and her family leave their house and going a little distance off erect a मढ़वा *marhwa* for the marriage ceremony. On the day appointed for the wedding, the bridegroom starts from his home with his servants under the pretence that he is going out hunting. None of his relations accompany him, and although they, of course, really know for what he is starting, they pretend to be ignorant. When he arrives within a little distance of the मढ़वा *marhwa*, he stops, and then the *sihānt* is proclaimed. By this time the marriage preparations are ready, and the bride's brother comes to him and conducts him to the appointed place. On his arrival at the door the bride's female relatives, each being called for this purpose a बिधन्करी *bidhankari*, catch hold of his nose with one hand, and with the other hold a sheet tied round his neck. In this condition they bring him into the मढ़वा *marhwa*, and there the marriage is performed.

1356. After a time the bridegroom's friends pretend that he has been lost in his hunting expedition, and send a man called the **खौत्र** *srautra* to look for him. He returns shortly afterwards, and informs them that the bridegroom has married so and so, whereupon they all fall to and abuse him. After abusing him they change their minds and reward him.

1357. At the marriage a barber ties some paddy in a knot in the bridegroom's waist-cloth (**धोती** *dhoti*). This is called **जन्म गेंठि** *janam genthi*. This is not untied until the fourth day after marriage, which is by this sect called the **चतुरथी** *chaturthi*.

1358. Another ceremony is the **दसौत** *dasaut*. In this a professional dancer (**नटुवा** *natura*) comes up to the bridegroom and offers him sham sweetmeats (**लड्डु** *laddu*), in return for which he receives presents. After this the bride and bridegroom go into the **कोहबर** *kohbar* to worship the family god. On the way the bride's female relations set up shops of paltry articles, which the bridegroom is obliged to buy.

1359. Another ceremony is **घसकट्टी** *ghaskatti*. In this the bridegroom cuts some grass for his father-in-law, and in return the latter promises to give him a horse.

CHAPTER IV.—MARRIAGE CEREMONIES AMONGST THE MUSALMĀNS.

1360. The writer is indebted to Kāzi Sayyad Raza Husain of Patna City for the following facts:—

1361. Amongst Musalmāns there are two kinds of marriage ceremonies,—**शरई** (**شرعی**) *sharai* and **उरफी** (**عرفی**) *urfi*, or religious and ceremonial. The more strict and educated members of the community follow the former, and the common people the latter.

1362. **शरई** (**شرعی**) *sharai* marriages are entirely free from ceremonies of any kind. After the betrothal the marriage is performed in strict conformity with the sacred law. The amount of dowry (**महर** (**مهر**) *mahar*) is not fixed, but depends on the pecuniary circumstances of the parties. Immediately after the marriage, the wife goes to her husband and is settled for life.

1363. **उरफी** (**عرفی**) *urfi* marriages are not so frequent as they used to be. The spread of education and railways has tended to make people stricter in their religious duties, but, specially amongst the lower

orders, the following ceremonies are still in vogue. In these marriages the dowry (महर (مهر) *mahar*) is always fixed. In the cities it is fixed at one *lākh* of rupees, and in the villages at forty-one thousand rupees and one *dīnār*. This is the amount of dowry promised by even the poorest people. It is needless to say that it is never given.

1364. Arranging the preliminaries, निवहान (نصبت) *nisbat*.—The parents first make themselves acquainted with one another's pecuniary circumstances, and the negotiations are carried on through a female match-maker (सुहाता (سوهاة) *mushāta*). When the preliminaries are settled, a letter of ceremony is sent by the guardian of the boy to the girl's family. This letter is written on red paper, or on white paper sprinkled with red. The carrier of the letter, on arrival at the girl's house, is given *sharbat* to drink, and detained for a day or two. The reply is written on similar paper and returned by him, and this correspondence settles the marriage question. From this time marriage presents are exchanged between the parties, the boy's guardian making the first present. If at this time any women come from the house of the bridegroom on a visit to the bride's house, the bride will not show her face to them.

1365. In some places, before the marriage is decided on the girl's guardians first see the boy. This may be done in two ways: either the girl's people send for the boy to their house, and serve him with betel-leaf, and give him rupees or gold *mohars*, or else the guardian of the bride sends some relative to the boy's house. There, on his arrival, he is given *sharbat* to drink, and the first thing given him to eat is sweetened rice (मीठा चावर *mītha chāvūr*). This relative reports concerning the boy to the girl's guardians.

1366. Betrothal.—This is मैंगनी (منگنی) *mangni*. In this the boy's guardian, after consulting with the other party to the contract, fixes a date, on which he sends presents with considerable ceremony. Large coloured earthen pots are filled with sweetmeats and fruits, and sent with a large party. In some places a suit of clothes is also sent. The pots are carried on the heads of maid-servants, who sing songs when they start and when they approach the bride's house. As soon as they arrive they are given *sharbat* to drink, and while they drink the bride's people sing abusive and obscene songs to them. The persons that supply them with *sharbat* receive a small present. The maid-servants are also given sweetened rice to eat in a dish covered with silver leaves and pieces of fruit. Sometimes they are given sweetmeats to eat first and then dishes prepared with salt. They are

detained for at least one day. When they leave the bride's house on their return journey, they are given presents in money and sometimes suits of clothes. They are also given a plain ring (बख्ता *chhalla*), a red handkerchief, and some sweetmeats as presents for the bridegroom.

1367. *The letter of promise* वादा का बख्ता (وعدا کا بختا) *wāda ka rukka*.—When the time of marriage approaches, the parties, either orally or in writing, fix a date for it. Afterwards a customary letter of promise is sent, written on red paper and sprinkled over with pieces of gold or silver leaf. The letter is to the effect that such and such a day has been fixed, and that the writer hopes that it will meet with approval. Amongst poor families, the letter is sent in a bag of red cloth or velvet, together with two betel-nuts, some green grass, one or two pieces of turmeric, and a little rice. Amongst rich families, the letter is sent in a silver or golden box. The box is placed inside an embroidered bag together with the betel-nuts, &c. The whole is sent on a silver plate. The letter is always carried by a barber, who is given a handsome present, consisting of cash, clothes, and utensils by the girl's guardian. The guardian sends a reply either through the same man or through a messenger of his own. A tailor is then sent by the girl's guardian to take the measure of the boy's dress. He also gets a present from the boy's people, on going away. The marriage must take place not more than two months after this correspondence.

1368. *The going into retirement of the bride and bridegroom* मायूँ (مأیون) *māyūn* or माँजा (مانجا) *mānjha*.—After the interchange of letters, the bride and bridegroom sit in *mānjha*.—The girl puts on a sheet dyed with safflower, and the women of the neighbourhood and her female relations assemble, and rub her with cosmetics (उबटन *ubtan*), singing songs as they do so. From that day the girl sits in a room, and never leaves it except for necessary purposes. She does not see the face of any man,—not even of her father or her brother. She eats only milk and fruits, and every day the barber's wife comes and applies cosmetic to her. In the meantime the boy is undergoing the same treatment. He wears similar dyed garments, is surrounded by females, and cosmetic is rubbed on his body every day. In South Munger he does not thus go into retirement.

1369. *The ceremony of the grindstone*—चक्की *chakki*—and the washing of the pulse—दाल धोई (دال شوی) *dāl shoī* or दाल धोई *dāl dhoī*.

Two or three weeks before the marriage a grindstone is put in one of the rooms of the female apartments of both the houses, which has been previously well cleaned. The following day a number of women assemble and singing, accompany the maid-servants who carry some *māng* (*Phaseolus mungo*) to a well or river. Arrived there, they joke and sprinkle water on each other, while washing the grain. They then bring it back in the same way. It is dried in the sun, and ground into flour on the grindstone by seven women whose husbands are alive (सोहागिनि *sohāgini*). It is then made into a dish called बरी *bari* for the ceremony of कंदूरी (کندوری) *kandūri* (see § 1377).

1370. *The cutting of the clothes.*—This is called किता पारन्चा (قطع پارچه) *kita pārchā*, and takes place in the bridegroom's house. Men and women are invited, songs are sung, and the tailor cuts out the marriage dress of the bride. When it is cut, all the men present congratulate the boy's guardian, and give the tailor a small present.

1371. A similar ceremony takes place in the bride's house on the day of the marriage procession. There the bridegroom's wedding garment is prepared, and when it is being despatched to him the male friends of the family assemble under a canopy in the female quarters. A few stitches purposely left unfinished in the bridegroom's drawers are then completed by the tailor, who gets some small fees from those present. This ceremony is called साज (or, in South Mungger, जाना) बेचोतब (ساز بیوتنا) *sāj* (or *jāna*) *beatāb*.

1372. *The vigil*—रतजग्गा *ratjaggā*.—This ceremony takes place in the houses of both parties. A spot in the house is washed, and a small wooden stool is placed therein. A new water-pot is placed on it, and is covered over with a new earthen cover. A red handkerchief is then tied on it. A garland of flowers is then placed round the neck of the pot, sweetmeats are cooked, and hymns sung entreating God to bless the bride and bridegroom. The women sit up the whole night near the water-pot, thereby intending to keep God awake. At dawn the sweetmeats and रिहम (رحم) *riham** and *sharbat* are offered to God. They are then distributed among the people.

1373. *The erection of the canopy*—सायाबन्दी (سایه بندی) *sāyā-bandī* or मँदूवा *mañdhwa*.—This takes place the day after the last ceremony. A canopy with four bamboo poles is erected in the female quarters. First, brown sugar is offered to the saint named *Shakarganj*, and then garlands are tied to each pole of the canopy. When the ropes of the canopy are being tied, the sister of the bride or bridegroom,

* Rice-flour mixed with clarified butter, sugar, and milk, and made into balls.

or any near female relation of the father of either, comes in and stops the work. The persons employed are not allowed to proceed till they have promised to pay her a sum of money. When the canopy has been safely erected, a paste of sandal powder is rubbed on the faces of those present. In some places, after the erection of the canopy, a goat or a cow is sacrificed in memory of the saint Shaikh Abdul Qādir Jilāni, (شيخ عبدالقادر جالاني). The flesh of the animal sacrificed is cooked on the spot where it was killed, with rice and gram, in new earthen pots. When cooked, it is offered in the name of the saint, and then eaten.

1374. The same night another ceremony takes place. A potter is ordered to make a small water-pot. This is coloured and painted with figures of horses and elephants. It is called कलसा *kalsa*. It is placed in the courtyard and covered with an earthen cover, on which ears of rice and mango leaves are put. A four-wicked lamp (चौमुख *chaumukh*) is kept burning on it every night. This pot is neither opened nor removed till the marriage ceremony is over. When it is first deposited, the women sing a song over it, the purport of which is, "We have shut up storm, rain, serpents, scorpions, and worms herein."

1375. On the same night another ceremony, called चिहल तन (چهل تن) *chihal tan* (forty persons), takes place. A number of beggars who play the drum and fiddle are invited, and towards the end of the night a pit, four or five feet wide and two or three feet deep, is dug under the canopy. In this pit large billets of wood are burnt, while the beggars play and sing hymns in honour of the same. When the fire begins to burn brightly, they one by one fall upon it and extinguish it with their bare feet. Sometimes they carry the bridegroom in their arms while performing the ceremony. When it is over, fried gram and fried wheat mixed with sugar are offered to the forty saints.

1376. *The song of Balaimiyan.*—This is called पौर का नजा (پیر کا نیرہ) *pār ka naija*, or बाले मीयॉ (بالی میان) *bālai miyān*. Next day the females of the neighbourhood are invited; a spot is washed beneath the canopy, and the green branch of a mango tree with leaves on it (or sometimes simply a wooden stick 3 or 4 feet high) is erected therein. A red handkerchief dyed with safflower is spread over it. The women then sing the song of *Bālai Miyān*. At the same time an अंखिया *ankhiya** is put in a new earthen pot, offered to the saint, and then distributed to the people.

* A kind of cake made of wheat-flour and rice-flour and boiled in water. It is shaped like the eye, *ānkhi*: hence its name.

1377. Offering to deceased elders.—This is called कँदूरी (کندوری) *kandūri* or बीबी के सन्नक (بی بی کی سناک) *bibi ke salnak*, and takes place on the same night as the last ceremony. An earthen fireplace (चूल्हा *chūlha*) is prepared at home and placed beneath the canopy. The maid-servants go singing to fetch water, carrying several water-pots covered with red cloth, and accompanied by musical instruments. They must be married women of good character; they may not be widows, or women who have married twice. In the water which they bring, rice, gram, *māng* (*phaseolus mungo*), fruits of the egg-plant, and pumpkins, &c., are cooked. When cooked, first the rice is distributed on earthen plates, then on it the pulse, then a little tyre prepared specially for the occasion, and then the vegetables and cakes. On each plate one betel-leaf and one garland is laid. In some places only rice, curds, and sugar, are put on the plate, and this is called मीठी कँदूरी *mīthi kandūri*. These plates are prepared in great number, and have been previously kept in a room washed for the purpose. Then the plates are offered, first one in the name of the prophet, then one in the name of his daughter *Bibi Fātma* (فاطمه), then one each in the names of many saints, and then one each in the names of the deceased members of the family, so far as they can be remembered. Great care is taken to make offerings in the name of all of the last. After this the females of the neighbourhood and those related to the family who have been invited assemble in a place in the courtyard (आँगन *āngan*) of the house, which has been well washed for the occasion, and sing songs in the praise of *Bibi Fātma*, and eat the offerings. No woman who has been married twice, or who is unchaste, dare eat out of these sacred plates.

1378. The anointing.—तेल चढ़ाव *tel charhāeb*.—This takes place in the houses of both the bride and bridegroom the day after the last ceremony. Each is made to kneel down on a wooden bench (चौकी *chauki*), and a yellow cloth is thrown over him or her. Then seven married women (सोहागिनी *sohāgini*) tie up seven cakes (सुहाली *suhāli** and पीठा *pītha*) in a yellow handkerchief, and wave it round their heads. Then they anoint the whole body of the bride or bridegroom with oil. A small bundle is made up of mustard seeds tied up in a piece of yellow cloth, and then tied on the arm of the bride or bridegroom. This is called कँगना बाँध *kangna bāndhab*.

* A cake made of flour and turmeric and fried in clarified butter.

1379. *The marriage procession.*—This is *बरियात bariyāt*, &c., as amongst Hindus; see § 1290. When the time for the departure of the bridegroom's marriage procession draws near, the maid-servants of the bridegroom's house go out, singing songs, to fetch water. On their return they are stopped at the gate by the musicians, who refuse to let them pass till a present has been made to them. The water is placed under the canopy, where also a small stool is placed. The male members of the family assemble there, and, as songs are sung, the brother-in-law of the boy, or any near relative, digs a pit there. This is called 'digging a pond,' *पोखरा खोदब pokhra khodab*. He also gets a present for doing this. The bridegroom then bathes at this place, and puts on his wedding garments, consisting of (a) coloured drawers, (b) a kind of overcoat (*जामा (جاما) jāma*) dyed with the safflower, or made of *प्रकरङ्गा ekranga* or of brocade (*असावरी (اساوری) asāvari*), (c) a white turban covered with a red cloth, or a red turban, (d) a garland of flowers, and (e) a handkerchief carried in the hand. He then mounts on horseback, and visits first the grave of some saint, where he makes an offering of sweetmeats, and then the village *imāmbāra* (*इमामबाड़ा (إمام باड़ा)*),* where he makes a similar offering. He then starts for the bride's house, and on approaching it he pays similar visits to the tombs of saints and the *imāmbāra* there. In the meantime the bride has also bathed, put off her *साँझा māñjha* dress, and put on another which has been prepared either in her own house or in that of a relative.

1380. When the time for the arrival of the bridegroom approaches, the bride's maid-servants set out on the road on which it will come, carrying with them rice soaked in water and a newly-made ladle (*डोर dōi*), to which is tied a piece of red cloth. They stop at a well or a river, lay the ladle down on the ground, and cross over it one by one, eating the rice as they do so. They then dig up a *चिरचिरा chīrchirā†* shrub which they had previously noted, and carry it home, singing songs. The root of the tree is ground up and made into pills, which are administered to the bridegroom on the night of the *जलन्वा jalwa* (§ 1384).

1381. *The sending of presents.*—This is called *साचक (ساقق) sāchak*. Before the arrival of the marriage procession a *बरी bari* is sent

* An *imāmbāra* is, according to Bihār tradition, a building erected in honour of the celebrated martyr Imām Hassan, the grandson of Muhammad.

† *Achyranthus aspera*, said to be of sovereign virtue to one bitten by a venomous reptile or stung by a scorpion, &c.

to the bride's house. This word has two meanings, viz. (1) a dish of cooked pulse, and (2) that here referred to,—all the following presents taken together. It consists of :—

- (1) Dresses for the bride, of from one to twenty-five suits. The first suit, or wedding dress (रौत के जोड़ा *rit ke jora*), is also called the शाहाना (شاهانه) *shāhāna* or royal suit. It is not worn after the fourth day of the ceremony. It consists of a pair of long drawers of satin cloth and a जामा *jāma* (see above) of brocade, *tasar* silk, or प्रकरङ्गा *ekrauga*. A second suit, also of fine materials, for the fourth day is called the चौथी के जोड़ा *chauthi ke jora*; and a third suit, for the tenth day, दसहरा के जोड़ा *dasahra ke jora*. Each suit is of less value than the preceding one.
- (2) The chaplet, सिहरा (سیرا) *sihra*, for the bride.
- (3) Some raw thread dyed with safflower. This is called नाड़ा *nāra* or कलावा (کلاوا) *kalāwa*, and varies in amount from one or two *chhatānks* to a maund.
- (4) Some otto of spices, सोहाग के अतर (سوهاگ کا اطر) *sohāg ke atar*.
- (5) Sweet-scented oil.
- (6) A cone-shaped basket (called सोहाग पूरा *sohāg pūra*) of bamboo, covered with red paper and containing चल्हचबेला *chhalchhabela*, नगर मोथा *nagar motha*, बाह चड़ *bāl chhar*, the bark of the bay-tree (तज *taj*), cardamoms, sandal-wood, grains of musk, nutmeg, mace, saffron, cassia, turmeric, &c.
- (7) Sweetmeats.
- (8) Fruits, viz. almonds, pistachios, grapes, dates, cocoa-nut kernel, &c.
- (9) Spices for betel.
- (10) Fifty-two water-pots. These are small in size and are gaily coloured. In each a little rice, some betel-nuts, and some mango-leaves, are put.

These things are carried on the heads of maid-servants in procession in trays, accompanied by torches, music, and fireworks. First comes a large tray carrying the royal robes, then small trays, on each of which is placed another suit, and then the rest. The whole is covered by a long piece of cloth called दलज्जकना *daljhakna*.

1382. In the meantime the bridegroom's dress is despatched from the bride's house, with a tailor, to meet the procession. The dress consists of a red **जामा** *jāma* (see above), long drawers of silk often worked with gold and silver flowers, a turban covered with a red handkerchief on which is laid a garland, and over this a very thin handkerchief, called **मकनना** (مکنا) *magna* or veil, and a red handkerchief, for him to carry in his hand. When the bridegroom is clothed in this by the tailor, he gives the clothes in which he has travelled so far to the barber, who follows the bridegroom, carrying an umbrella over his head. Then the ceremony of **निकाह** (نکاح) *nikāh* or religious marriage is performed, and dates and sweetmeats distributed to the assembled guests.

1383. After this the bridegroom goes on horseback to the bride's house with great pomp, accompanied by a large party of men with torches, fireworks, and music. When they reach the house, all the men remain standing outside, while the bridegroom enters the female quarters of the house either on foot or horseback. There he sits on a wooden stool (which is given him in dowry), and his mother-in-law (or if she be dead, some other female relation of the bride) comes to him carrying a plate containing a small lamp made of flour and a little **अरन्वा** *arwa* rice. She warms her hand at the lamp, and then touches the cheek of the bridegroom. While she is doing this, a woman comes and whispers in his ear the following Hindi verse "सोने में सोहागा, छर्र मैं तागा। ओ दुलन्हा का मन दुलन्दिन से लागा ॥ *some men sohāga, sūi men tāga o dulha ka man, dullin se tāga, i.e., borax* in gold, a thread in a needle, and the bridegroom fell in love with the bride.*" Then six married females (**सोहागिनि** *sohāgini*) and the mother-in-law alternately touch the cheeks of the bridegroom with the **अरन्वा** *arwa* rice. He is then given some *sharbat* to drink. This is prepared in various ways: sometimes the wet hair of the bride after she has bathed is dipped into it, sometimes a small piece of sugar is put into her hand till it becomes moist with the perspiration, and then the *sharbat* is made of it, and sometimes it is made of a piece of sugar which she has taken into her mouth and crushed between her teeth. Then the bridegroom stands on the wooden stool, and a maid-servant carries in the bride in her arms, and touches the back of the bridegroom with her feet, and takes her away: then the bridegroom returns to his own party.

* Borax is a flux for melting gold.

1384. The **जलवा** *jalwa*.—The day after the arrival of the procession, milk, a dish called **मलीदा** (مالیدة) *malida* or sweetmeats, and *sharbat*, are sent from the house of the bride to the bridegroom's party. The **मलीदा** *malida* or sweetmeats are put into the milk and drunk by the bridegroom out of a cup of silver or copper, which is given to him afterwards in dowry. Then the others drink it. The same evening maid-servants come from the bride's house singing songs, and take away the procession umbrella, and under its shade seven married females grind the spices which came in the **सोहाग पूरा** *sohāg pūra*, and when ground, apply the powder to the hair of the bride which they also tie with the **नाड़ा** *nāra* or string which came at the same time. The scented oil is also applied to her hair. Then the bride puts on the royal dress, a garland of flowers, the chaplet **सिहरा** (سیرا) *silra*, and a veil, which is thrown over her face. She takes off all the ornaments of her maidenhood, and puts on new ornaments sent her by the guardians of the bridegroom. Black powder (**मिस्सी** *missi*) is applied to her teeth, and she is adorned in every other practicable way. During the day, it may be added, myrtle leaves have been applied to the soles of her feet to make them red. When she is ready, the bridegroom is sent for, and he comes walking, preceded by a maid-servant walking backwards, and carrying a plate on which is a burning lamp, so arranged that the smoke is thrown towards the bridegroom. When he reaches the gate of the female quarter of the house, the mother of the bride, or (if she is dead or a widow) any other married woman, meets him, and conducts him inside. The manner of doing this varies in different places. Sometimes the mother carries in her hand a plate in which lamps made of flour or silver are burning, and the wicks of which are of red cloth. A small quantity of the red thread (**नाड़ा** *nāra*) already mentioned is also laid on the plate. She walks backwards with her face towards him, and at every step throws down a piece of thread, and asks the bridegroom to pick it up and lay it on the plate. In this way, and at the same time touching his cheeks with her hand warmed at the lamp, she takes him into the inner yard, under the canopy. In other places the mother-in-law gives him betel to chew, which he bites and throws away.

1385. When the bridegroom comes under the canopy he sits on a wooden stool near a bed. As long as he stays there his sister (or, in her absence, a maid-servant) spreads a portion of her cloth (**सारी** *sāri*) over his head. Then the match-maker (**मुशाना** (موشان) *mushāna*) throws a string round his neck, and pulling it gently, refuses to

let it go till she is paid something. A cloth is then hung between the bed and the stool, and the match-maker (who has also had charge of adorning the bride) makes her stand on the bed in such a way that the bridegroom can only see her face. She then places the two hands of the bride on her (the bride's) forehead, and moves the bride's head this way and that way. A coloured handkerchief, in which is tied rice and turmeric, is then given to the bridegroom, who throws it on the bride, and each time he does so he is given a betel leaf in which pieces of the root of the चिरञ्चिरा *chirchira* shrub already mentioned are wrapped up. This moving of the head and throwing of the handkerchief is repeated seven times, and the ceremony is called जलन्वा देब (جاءه ولى) *jalia deb*. The bridegroom then sits on the head of the bed, and the match-maker takes off the chaplet and veil from the face of the bride and shows it to the bridegroom, who for this favour gives her a present, and at the same time receives presents from the female relations of the bride. Sometimes, after this is done, a cup containing sandal-wood and a finger-ring of silver, which has a small cup made in the place where there is usually a stone, is given to the bridegroom, who, after dipping the ring into the sandal-wood, touches the forehead of the bride with it. In other places vermilion (चहर *senur*) is used instead of sandal-wood.

1386. Then the wife of the bride's brother, *i.e.*, the bridegroom's सारहाज (سارهه) *sarhaj*, comes and sits on the bed, and throws little balls of flour at the bridegroom, who does the same to her. This ceremony is called गेंद खेलाब *gend khelab*. A maid-servant then carries off the bride in her arms, followed by the bridegroom, who catches hold either of a corner of the bride's sheet (चहर *chuddar*) or her finger.

1387. It must be noted that throughout all these ceremonies the bride has kept her eyes shut, and never moves on foot, but is always carried in the arms of a maid-servant.

1388. The bride and bridegroom are then made to stand in an outer room (दलान *dalān*), and in the hands of both a little rice is put, but the hand of the bride is turned backwards. They are then caused to toss their hands up in the air, by a maid-servant, and thus the rice is scattered through the house, and the bride says at the same time that she is filling the house of her father and mother. The bridegroom also says that he is filling the house of his father and mother-in-law. This ceremony is called घर भरब *ghar bharab*. The bride is then carried

off to a well-furnished room, where the bridegroom takes off her shoes with his own hands.

1389. *The departure of the procession.*—This is *rukhsati* (رخسائی) and takes place on the third day after the above-mentioned ceremony. The bridegroom is called into the female apartments, and he and the bride are given rice-milk *khīr* (کھیر) to eat. He affects displeasure, and refuses to eat with her. The mother then makes him a present, and he consents to do so. Then the bride and the bridegroom sit together on a carpet, and a small piece of sugar on a betel-leaf is placed first on her head, then on her shoulder, then on the palm of her hand, then on her knees, and lastly on her feet. The bridegroom is pressed to pick up the pieces of sugar from each place with his mouth, or at least with his hands. This ceremony is called *nabāt chūnab* (نبات چُوناب).

1390. When the bridegroom goes off to his own house with the bride, she is carried in the arms of a maid-servant, and keeps her eyes shut till she reaches the court-yard of her husband's house. The sister of the bridegroom first meets her with a jug of water and washes her feet in a plate, which she (the sister) keeps as her perquisite. After this the ceremonies of *ghar bharaḥ* (घर भरष) and *nabāt chūnab* (नبات चُوناب) are performed again in the bridegroom's house.

1391. *The ceremony of the fourth day.*—This is *chauthi* (चौथी) or *chauthāri* (चौथारी). It takes place on the fourth day after marriage, *i.e.* on the day after the arrival of the bride and bridegroom at the latter's house. The bridegroom takes off the thread *nāra* (नाड़ा) with which the hair of the bride had been tied. The women of the family then bathe the bride in the female apartments, singing songs at the same time, and the bridegroom himself bathes outside. Sometimes the bridegroom also bathes inside. The bride then puts on her dress made for this day (see § 1381), and the bridegroom also puts on the dress given him by his father-in-law. The bridegroom then enters the female apartment, and joins in the ceremony of *jūā* (जूआ), or gambling. Seven spotted shells (*chitti kauri*) (चिती कौड़ी) and a necklace (*chandān hār*) (चन्दन हार) are thrown up in the air. A maid-servant extends the bride's hands, and the bridegroom his own, and both try to catch the falling necklace. The one who succeeds wins the game.

1392. Two or three days after the arrival of the bride in the bridegroom's house people come from her house to take her back. The bride's

younger brother and other relations may form some of the party, but not elders, such as the father or uncles. They bring with them presents of sweetmeats, rice, pulse, a goat, &c., varying in quantity according to means. Two or three days afterwards they return with the bride and bridegroom.

1393. *The ten days' stay.*—This time the bridegroom stays nine or ten days in his father-in-law's house. This stay is called the दसहरा **दसहरा** *dasahra khāna*. On their arrival a room is made over to the bridegroom in the female apartments, and the bride is made to walk into this room accompanied by her female relatives and those of her husband, all singing songs. This is the first time the bride is allowed to walk since the commencement of the ceremonies. Up to this she has been always carried about. When the bride approaches the bridegroom in this room, he is expected to salute (सलाम *salām*) her. If he does not do so, showers of abuse are poured upon him.

This concludes the wedding ceremonies.

CHAPTER V.—BIRTH CUSTOMS GENERALLY.

1394. An adopted child is amongst Musalmāns मोतम्मन्ना (موتمننى) *motmannā*. Amongst Hindus he is पालक *pālak*, पोसपुत *posput*, or पोसपालक *pospālak*. Local names are पोसबेटा *posbeta* or पोसबालक *posbālak* in the south-east, and कर्ता पुत्र *karta putr* in East Tirhut. To adopt a child is पोसिया लेब *posiya leb*, गोद लेब *god leb*, or रास पर लेब *rās par leb*.

1395. When a woman cannot suckle her child, owing to pains in and hardness of the breast, she is called थनैलियाही *thanailiyāhi*. Inability to suckle on this account is थनैली *thanaili*. When a child is not well nurtured owing to the untimely death of its mother, or to her milk running dry, it is called दुधकटुआ *dudhtutua* or दुधकटुआ *dudhkatua*. In South Bhagalpur it is कलत्रा *kaltra*.

1396. A seven-months' child is सतव्वाँस *satwāns* or सतव्वाँसा *satwānsa* generally; also सतव्वाँस *satwānsu* south of the Ganges, सतमास *atmās* in North-East Tirhut, and सतमसुआ *satmasua* in South-East Tirhut and South Bhagalpur. An eight-months' child is अठव्वाँस *athwāns* generally; also अठव्वाँस *athwānsu* south of the Ganges, अठमास *athmās* in North-East Tirhut, and अठमसुआ *athmasua* in South Bhagalpur.

1397. An only child is प्रकलौता *eklauta*; also प्रकडला *ekdhula* in Shahabad and प्रकौनिषाँ *ekauniyān* in South Bhagalpur. A first-born child is पहिलौटा *pahilautha*. The youngest child, i.e., the last which a woman has, is called पेट्पोँडुआ *petponchhua* or कोर-पोँडुआ *korponchhua*. When a girl is born after three boys (which is considered very lucky), she is called a तेतर *tetar*, and she is even often named तेतरी *tetri*. In the south-east, however, a girl born after two and not after three boys is so called. A child whose elder brother is dead is called मराह *marāhh*, or मरहवा *marachhua*, or (in South Bhagalpur) मरोहा *marochha*, and (in North-East Tirhut) मरहै *marchhāi*. Such children are treated and dressed as girls, sold to the midwife for a few cowries, and brought back again and given opprobrious names, in order to induce the demon of death to think them of small account and not worth killing.

1398. When a woman has a child every year she is बरसाइन *barsāin*, or in South Bhagalpur बरसैनी *barsaino*. A woman with only one child is प्रकौज *ekaunj*, or to the east काक बन्हा *kāk banjha*, or कौआ बाँह *kaua bānjh*. The latter name is said to be derived from the children's game of काग दुस *kāg durus*, or "odd or even." In this game one boy guesses whether another has an odd or even number of cowries in his hand. If he guesses an odd number he says काग *kāg*, or if an even one दुस *durus*. Hence काग *kāg* means an odd number, and specially 'one.' A barren woman is बाँह *bānjh*, बाँह बहिला *bānjh bahila*, or (in the south-west) बाँहिन *bānjhin*. A woman after delivery, until the purificatory ceremonies are performed, is अलन्वाँती *alcāntī* or परन्सौती *parsauti*. The lying-in room is north of the Ganges सोदरी *soiri*, and to the east also सोएर *soer*. South of the Ganges it is सौर *saur*, सौरी *sauri*, or जच्चा खाना *jachcha khāna*. In this a fire is kept burning for ten days after the woman's delivery. This fire is known to the north-east as अगिघासी *agiyāsi*, and in South Bhagalpur as पोड़ा *pora*. Elsewhere it is पसँघी *pāsanghi*, with a variant पसँगी *pāsangi* in the south-west and in South Munger.

1399. The presents given to a woman in a state of pregnancy are known as सधोर *sadhōr*. In South Bhagalpur such presents are given after delivery, and are called सठोरा *sathōra*. अह्वानी *achhwāni* is caudle given to a lying-in woman to produce milk. It is also called सोठौर *sothaur* in the north-east and सँठौरा *sonthaura* in Gaya and the south-west. Another name current in the north-east is

अधरस्त्री *adhrassi*; in South Munger it is कदवा *kadwa*, and in South Bhagalpur आदो गूड़ *ādo gūr*. The longing of a pregnant woman is दोहद *dohad* or मनचलब *manchalab*. The earthen cakes which she is fond of eating when in this condition are called अपन्ना *khapra*.

CHAPTER VI.—CEREMONIES PECULIAR TO THE BIRTH OF A HINDU CHILD.

1400. When the labour pains commence, the चमारनि *chamāni* or चमैनी *chamaini*, i.e. the native midwife, is sent for. She is also called दगनरिन or डगनरिन *dagrin*. On her arrival she puts a finger-mark (टीका *tika*) of vermilion on the wall. This ceremony is called सोरारी *sorāri*, and is supposed to hasten the delivery of the child. As soon as the child is born, the midwife washes the forelock (लट *lat*) and feet (गोर *gor*) of the mother, which operations are called लटधोआर *ludhoā* and गोरधोआर *gordhoā* respectively. She gets a fee (नेग *neg*) for doing this. The child's navel-string (नार *nār*) is then cut. If the child is a मराह *marāh* (or मरहवा *marachhwa*), i.e. if the child which was born before it from the same mother is dead, the navel-string is all thrown away. Otherwise it is buried in the floor of the lying-in room, and over it the fire (पसंगी *pāsanghi*) is placed. The latter is called in South Bhagalpur पसनी *pasni* or घूर *ghūr*. The child's body is then rubbed with कोठवार *kothwār*, which is the dust of a sun-dried granary (कोठी *kothi*), in order to take off the foetal excretion (जावर *jāvar* or जाँवर *jāmwār*). The midwife's fee for cutting the navel-string is नारकटार *nārkatāi* or नरकटार *narkatāi*.

1401. When the child's body has been thus rubbed with dust, it is bathed in lukewarm water, and then the midwife throws it up in the air and catches it again five times. This is called लरिका लोकाग्रब *larika lokābh*. At the same time another woman strikes a brass dish (थारी बजाग्रब *thāri bajābh*), and the mother holds in her hand a handful (अंजुरी *anjuri*) of grain, which last is the perquisite of the midwife. The after-birth (लिहनी *lijhni* or नार पुरैन *nār purain*),* &c., is then thrown away in a vessel called अपनौर *khapraur* or (in Gaya) अपनौरि *khaprauri*, for which the midwife receives a fee called अपनौर फँकार *khapraur phenkāi*.

1402. Two or three days after the birth, when the पनोहित *prohit* or family priest has fixed on a lucky day, the ceremony of महावन

* The after-birth of an animal, as distinguished from that of a human being, is कर *jhar* or कार *jhār*.

nahāwan is performed. This consists in नीम *nim* (*azadirachta Indica*) leaves being boiled in water, and both the mother and child being bathed with the decoction. Then a handful of seeds of राई *rāi* (mustard, *sinapis racemosa*) and जैवंदन *jeñvāñin* (dill, *ligusticum ajowan*) is waved (निहावर करव *nichhāvar karab* or औँखव *aunchhab*) round the mother's head and thrown into an earthen cup containing fire. When the seeds are consumed, the cup is upset, and the mother breaks it with her left foot. Then she sits with grain in her hand, while the brass dish is again beaten, and the midwife again throws the child five times in the air. This all takes place in the court-yard of the house, and is done to avert the evil eye. It is the first day on which the mother comes out of the lying-in chamber. The same day this chamber is plastered over with fresh mud, amongst the rich by a maid-servant, and amongst the lower classes by the husband's sister ननद (*nanad*), who gets a fee for this, called सोदरी लिपाई *soiri lipāi* or (south of the Ganges) सौर लिपाई *saur lipāi*. The same day the washerman takes away the lying-in clothes (कुतका के कपड़ा *chhutka ke kapra*), and washes them. His fee for this is called कुतका *chhutka*.*

1403. The next day after bathing, the barber pares the mother's nails, which ceremony is called नोहन्डङ्गी *nohtungi* or नहन्डङ्गी *nahungi*, and his fee is known as नोहन्डुंगाई *nohtungāi*.

1404. On the seventh or eighth day, when the mother is first able to eat rice, the ceremony of छेँही जोड़ाव *kheñrhi jorāeb* is performed. A hole is dug in the ground, into which milk and water are poured. The mother sits close to it, and eats her first dish of cooked rice. From this day collyrium (काजर *kājar*) is put on the child's eyes. Before this, when oil was rubbed on the child's body, the child had been laid on its back during the operation, but henceforward it is laid on its face for the application. From this day, also, the mother gets a bed to sleep on. Up to this day she had been fed only on caudle and on a mixture of oil, turmeric, and molasses (हरदी गूर *hardi gūr*).

1405. On the twelfth day the ceremonies of दोनी आँकव *donni jhānkab* and च्छठी *chhatthi* are performed. Sometimes the latter ceremony is omitted. In the former, five दोनी *doni* or दोना *dona*, which are a kind of platter, are prepared of leaves of the jack-tree (कठर *kathar*). In these cakes (पूरी *pūri*), rice milk (खीर *khīr*), &c., are placed. Sometimes the leaf platters are omitted, and rice milk, &c., is simply laid

* The washerman caste is considered an unclean one because its members touch these garments.

on the ground over the cakes. Worship is then performed, and the articles eaten.

1406. The **बढी** *chhathi* or **बढी** *chhatthi* ceremony is also called in Tirhut **बढियार** *chhathiyār* or **बढि** *chhathi*. As its name indicates, it should properly be performed on the sixth day after birth, but this rarely occurs now-a-days. When it is held on the twelfth day it is also called **बरन्ही** *barhi*. In this ceremony a kind of square marked with diagonals and made of cowdung is fastened on the wall. At every corner and intersection cowries are fastened, and the whole is painted with vermilion, and cakes, &c., are laid before it. The child is then oiled, has collyrium applied to its eyes, is wrapped up in a cloth, and placed before it. It is then dressed in new clothes, and rings (**करा** *kara*) are put upon its arms and feet for the first time, and some money put into its hand. On this day also the child is named, and the relatives are fed.

1407. The ceremony of purification performed on the fortieth day after birth is called **चिहा** *chhilla*. In South Munger a similar ceremony takes place on the twentieth day, and is called **बसदौरी** *basdāuri*. The ceremony of first feeding the child with rice is called **अनन्प्रासन** *anprāsan*, also (south of the Ganges) **खिरखियाद** *khirkhiyāi* and **खिरचदार** *khirchutāi*. In Gaya it is **निमक चसी** *nimak chasi*, and in South Munger **चटावन** *chatāvan*.

CHAPTER VII.—BIRTH CUSTOMS AMONGST MUSALMĀNS.

1408. The navel string (**नार** *nār*) is cut by a **चमैनी** *chamaini*, and the child is then bathed **गोसल कराब** (**غسل کرنا**) *gosal karāb*. Sweetmeats are then consecrated (**नियाज करब** (**نیاز کرنا**) *niyāj karāb*) in the court-yard by the male members of the family, and the milk of a respectable and virtuous woman is given to the child in a shell (**सितुहा** *situha*). This ceremony is called **दुधपिलाद** *dudhpilāi*. The people are then called to prayers by striking a brass pan (**थारी** *thāri*) with a stick, and this custom is called **बन सलवात** (**بن سلوات**) *ban salwāt*. In South Munger it is called **बाँग सलवात** *bāng salwāt*.

1409. The lying-in room, in which the mother (**परन्सौती** *parsautī*) is, is always kept warm with an **अंगेठी** *angethī* or moveable stove, and is called **सौरी** *sauri*, &c. ; see § 1398. Caudle (**अह्वानी** *ahhvāni*) is given to her to produce milk, and oil mixed with turmeric and molasses is given to her to make her strong. This last mixture is called **बरन्दी गूर** *hardi*

gūr. Until milk flows in the mother's breasts, the child is wet-nursed with the milk of the woman whose milk was given to it immediately after it was born.

1410. On the third day the mother and the child are bathed and dressed in new clothes, and the women of the neighbourhood come and sing songs, and receive oil and vermilion. Up to this the mother has had nothing to eat except the caudle and the mixture already mentioned, but now she is allowed to eat food and to sleep on a bed. . . .

1411. On the same day the washerman takes away the lying-in garments, and the barber pares the mother's nails and shaves the child. The former operation is called नखन्दङ्गी *nahtungi*, and the latter बाल तराशी (بال تراشي) *bāl tarāshī*.

1412. The fees of the midwife (चमैनी *chamainī*), of the washerman, and of the barber, are all known as परन्सौती के कामाद *parnsautī ke kamāi*.

1413. On the same day the lying-in room is plastered over with mud plaster. This operation is known as सोर लिपाद *soer lipāi*.

1414. On the fortieth day the consecration ceremony (नियाज (نیاज) *niyāj*) is again performed, and the relations are fed.

1415. Circumcision is खतना *khatna* or सुन्नत *sunnat*. See also § 386.

CHAPTER VIII. - DISPOSAL OF THE DEAD AMONGST THE HINDUS.

1416. The burning of a corpse is दाह देव *dāh deb*, चागि देव *āgi deb*, दग्ध करब *dagudh karab*, or जारब *jārab*. In North-East Tirhut it is also संस्कार देव *sanskār deb*, and in the south-east जराएब *jarāēb*. When a Hindu dies he is taken out of the house and placed on a bier. A bier is रथी *vanthī* generally; also टिकन्डी *tikthī* in South-West Shahabad, टाटी *tāti* in the east generally, डाठ *dhāth* in North-East Tirhut, फड़की *pharki* in South-East Tirhut, and चचरी *chaclari* in South Bhagalpur. Sometimes he is simply placed on a bed (चरपाद *charpāi* or खटिया *khatiya*). Four men, who are called मजिल ले जानिहार *majil le jānihār*, or in South Bhagalpur कनकठिया *kankathiya*, carry the bier on their shoulders and set it down on the ground outside the village. This is called नगर बिसर्राँव *nagra bisrāñw* and is done in order that the people who are to accompany the corpse (who are called मजिलिहा *majiltha*) may collect.

1417. After the departure of the corpse from the house the walls of the latter are plastered over with fresh plaster, and outside it are placed a stone, cowdung, iron, fire, and water for the मज्जिहिवा *majiliha* to touch on their return from the cremation.

1418. The four men who carried the bier take it on, when the people have collected, to the place of cremation on the bank of a river. This place is called अस्मसान *asmasān*, or सुरन्दरहठी *murdhatti* north of the Ganges. In North-East Tirhut it is समसान *samsān*. South of the Ganges it is चिरार *chirār* or चिरारौ *chirāri*, or to the South-East मरगघठी *marghatti* or सुरगघटिया *murghatiya*. In East Tirhut it is also called मरगघठ *marghat* or सुरगघठी *murghatti*. They then bathe the corpse (नहनाप्रब *nahcāëb* or असनान कराप्रब *asnān karāëb*). The heir or chief mourner (करन्ता *karta*) then has his head, beard, and moustaches shaved (भदर कराप्रब *bhadr karāëb*), and puts on a dress of mourning (उतनी *utri* or कफनी *kaphni*). He then dresses the corpse in new clothes, viz. a waist-cloth (कच्चा *kacchha*) and a sheet, washes its mouth, and then with the assistance of the other men places it on the funeral pile. To dress a corpse in this way is कफनाप्रब *kaphnāëb*.

1419. A funeral pile is चिता *chita* generally, also चैती *chaiti* in Gaya and सारा *sāra* in Patna and the south-east. To prepare it a trench is dug in the form of a cross and four pointed logs (खूँटा *khūntā*) are driven into the ground at each end, and between them the logs of wood are piled. When the corpse is placed on the pile, the chief mourner (करन्ता *karta*) anoints its mouth with a mixture of गुगुल *gugul* (gum of the *amyris agallocha*), barley, incense (धूप *dhūp*), water-nut (मखाना *makhāna*), honey, sesamum, and sweetmeats. He then buys fire (आगि मोल लेब *āgi mol leb*) from a डोम *Dom* (some, however, take fire from the house), and with it lights a long torch (लूका *lūka*). He then walks round the corpse five times, touches its lips each time with fire (पचन्करन्ता *pachkarma*), and sets fire to the pile (दगध करन *dagadh karab*). When the body is nearly burnt, each of the persons present throws five sticks into the fire. These are known as पचकठिया *pachkathiya* north of the Ganges; in Gaya and the south-west they are पंचआगि *panchāgi* or पंचआगिन *panchagin*; in Patna they are पंचलकड़ी *panchlakri*; and in the south-east as पचकाठ *pachkāth* or पचकाठी *pachkāthi*. When the body is nearly all consumed, the fire is put out (पानि देब *pāni deb*) with handfuls of water, and the remaining small unburnt portion is thrown into the river for fishes and tortoises (महकह खा *machhkahh la*). They then wash the place where the body

was burnt, and the chief mourner (करन्ता *karta*) plants a *tulsi* tree near by, and writes on the ground the words राम राम *rām rām*.

1420. They then bathe at another landing-place (घाट *ghāt*) and sit down. Then the करन्ता *karta* gets up first and walks towards home, followed by the others. When they arrive at the door of the house, they touch the stone, cowdung, iron, fire, and water already mentioned, and then their left ears, each with the little finger of his left hand. This ceremony is called कान काठी उतारब *kān kāṭhī utārab*. They then separate. Some castes, however, instead of performing this ceremony, simply bite a piece of bitter *nim* leaf, and then go home.

1421. Offerings are sometimes made to the manes at the time of cremation, and these are called in South Tirhut अस्मसान पूजा *asmasān pūjā*, or पंचपिण्डा *pañchpiṇḍā*.

1422. The day after the funeral the करन्ता *karta* goes to the place of cremation, and pours on the site of the pile a little fresh milk. This is called चिता सेराणब *chīta serāḅ*. He then comes to the village *pīpat* tree, where he finds the barber and the family priest (पन्रोहित *prohit*) waiting for him. The former has some fresh milk, and an earthen vessel (कंठिया *kantiya*) carried in a sling (सिकन्हर *sikhar*) of मूँज *mūñj* rope. There is a hole in the bottom of the pot, partially stopped up with a plug. The *karta* haugs this up on a branch of the tree, so that its contents will drip out through the hole on to the root. He then fills it with milk and water and covers the vessel with an earthen cup (दकनी *dakni*). He then goes round the tree three times, and goes home. The whole of this ceremony is called घण्ट टाँगब *ghant tāngab*. On reaching home he feeds his relatives with rice-milk and *urid* pulse, and himself eats off a potsherd (खपन्री *khapri*). Before commencing to eat, each person places a small quantity of rice and milk from his platter (पत्तल *puttal*) apart on another platter. This is called बचाब काढ़ब *vuāb kārahb*, and the whole ceremony is called दुधमुँह *dudhmuñh* or दुधमुँही *dudhmuñhi*, and also दुधी *dudhi* in South-East Tirhut.

1423. The same evening and every evening up to the tenth day (दसवाँ *daswān*) after the death, the करन्ता *karta* lights a lamp made of mud and placed on the top of a stick. The first day it is placed at the spot where the deceased died. The second day at a little distance from it, towards the door. The third day further off again, and so on, it being arranged that on the evening of the tenth day it reaches the spot outside the door where the five articles (stone, cowdung, iron, fire, and water) were placed.

This rite is called **दीया बानी** *diya bāti*, or (in East Tirhut) **सुख राति** *sukh rāti*, and in Patna **चिराय बत्ती** *chirāy batti*. Up to the tenth day the **करन्ता** *karta* every day after bathing throws into the river or the well a handful of sesamum (**तिल** *til*) mixed with rice and water. This is called **तिलाँचुर देब** *tilānjur deb*.

1424. On the third day after the death the rite of **तिराती** *tirāti* is performed, and in South-East Tirhut, on the fourth day, the **अथन्सचन** *athsanchan*. On the seventh day is performed the **सतननहाप्रब** *satnahāēb*. In this the male members of the family touch oil and oil-cake (**खरौ** *khari*), and then bathe. When they return, the females do the same, and on their return to the house they put oil and vermilion on their heads, and a little gram soaked in water (**अकुरी** *akuri*) is given to each.

1425. On the tenth day is performed the rite of **दसकरम्म** *das karm*, also called **दसवॉ** *dasvān*, and in Tirhut **दसगातर** *dasgātr*, and in North-West Tirhut **दसाही** *dasāhi*. On this occasion the male relatives shave their heads, and those who are sons of the deceased their moustaches also. Then the Brāhman who performs such obsequies, and who is called **कण्टाहा** *kantāha* or **महाबाहन** *mahābāhan*, comes, and performs the ceremony of making obsequial offerings **पिण्डा पराप्रब** *pinda parāēb*. If the deceased is a male, this Brāhman gets as a fee all the requirements of a man (clothes, bed, shoes, umbrella, fan, dishes, lota, &c.), and, if a woman, all those of a woman. On the eleventh day offerings (**पिण्डा** *pinda*) are again made.

1426. Brāhman are then feasted. This is called **ब्रह्मभोज** *brambhoj*, **भोज** *bhoj*, or **कारज** *kāraj*. Amongst Brahman this takes place on the 13th day after the death, amongst Rajpūts on the 14th day, amongst Vaisyas and amongst some Sūdras on the 16th day, and amongst other Sūdras after the expiry of a month. The ceremony is as follows:—In the day-time, the **परोहित** *prohit* or family priest performs the **पिण्डा** *pindu* ceremony, and after it the **करन्ता** *karta* sits on a square marked on the ground (**चौका** *chauka*). A new turban is tied round his head, and he is dressed in new clothes. This is called **पगन्डी बन्हाप्रब** *pagri bankāēb*. The relatives also put into his hand an offering of money, called **नेवन्ता** *neota*. Brāhman are then fed (**ब्राह्मण जेवन्तार** *brāhman jeonār*). Afterwards, in the evening, the caste brotherhood are fed. On this day the widow of the deceased is clothed in her widow garments, which are known as **रङ्गसारी** *rañr sari*, or (in Tirhut) **रङ्गसार** *rañrsār*. Amongst the upper castes this is a white cloth, but amongst the lower ones it is a coloured one.

1427. In the case of the death of a male, पिण्डा *pinda* ceremonies are performed six months and a year after death: the first is called चामासी *chhamāsi*, and the second बरखी *barakhi*. When, however, a marriage has to be celebrated in the family, the ceremony is performed three months after death, and is called तिनपखी के पिण्डा *tinpakhi ke pinda*. On all these occasions also Brāhmans and the caste brotherhood are fed.

1428. When all the funeral ceremonies have been performed in the orthodox way, they are called किरिया करम *kirīya karm*. When the body is merely thrown into a running stream, it is called परगवाह *parvāh* or जलपरगवाह *jalparvāh*. On five days in the month a body must be burnt with five effigies of कुस *kus* grass (*poa cynosuroides*). These images are known as कुसपुत्र *kusputr*, and the days as पञ्चक *panchak* or पचका *pachka*. In the south-east they are पञ्चक *pachchak*. The visit of the women to condole after a death is मुंह देख *muñh dekh*, पुहारो *puchhāro*, or पुहारो *puchhāro*.

1429. Some Hindu and semi-Hindu sects and castes bury their dead. The principal of these are *Kabīrhas* (कबिरवा *kabirha*), Saiva mendicants (अतीथ *atīth* or सन्यासी *san'yāsi*), Sib Nārains (सिब नारैनी *sib nāraini*), and *Mushars* (मुसहर *mushar*). To be buried is समाधि (or समाध) लेब *samādhi* (or *samādhi*) *leb*, and to bury is मिट्टी देब *mitti deb* or समाध में बैसाव *samādhi meñ baisāv*. The body is bathed and dressed in new clothes, the necklace (कण्ठी *kanthi*) and sectarian mark (तिलक *tilak*) are put on his neck and forehead respectively, and he is seated in the grave facing the north with the feet crossed under the buttocks (पल्लवी बैसव *palthi baisav*) and with cakes in his hand.

CHAPTER IX.—DISPOSAL OF THE DEAD AMONGST MUSALMĀNS.

1430. The corpse immediately after death is taken out into the verandah (साबान *sābān*) or court-yard (आँगन *āngan*). It is stripped and a new waist-cloth (लूंगी *lūngi* or लुङ्गी *luvgi*) is put on it. It is then washed (गोसल कराव *gosal karāv*) (غسل کرانا *gosal karāv*). The man who washes has a kind of bag (called साफ़ी (صافی) *sāfi*) on his hand, with which he wipes the corpse. He then performs the ceremonial ablution of the corpse (वजू कराव *waju karāv*) (وضو کرانا *waju karāv*). This consists in cleaning its teeth, washing its hands, inside of the mouth, forehead, face, arms, and feet. He then dries it with a clean

साफ़ी (صافي) *sāfi*. The waist-cloth is then taken off as unclean, and is given to the barber, who attends to call the relations, and, when they are assembled, to look after their refreshment. A fresh waist-cloth is then put upon the corpse. Amongst the *Sunnis* this washing is generally done by friends of the deceased, but amongst *Shias* there is a special class of men who perform this work. The water with which the corpse is washed has been boiled with leaves of the बैर *bair* tree (*sizyphus jujuba*), and to this plain water is added. This washing is said to preserve the corpse from decay for a short time.

1431. A sheet is now taken, and a hole torn in the middle, through which the head of the corpse is put. The rest of the sheet hangs down before and behind. It is called झूल *jhūl* or कफनी (كفني) *kaphni*. The corpse is then laid on a bed (चारपाद *chārpāi*), decently covered with a sheet, and taken to the grave-yard, which is known as कबरिस्तान (قبرستان) *kabrīstan*. The funeral itself is called जनाजा (جنازة) *janāja*. The prayers recited at the grave-yard or in the yard of a neighbouring mosque differ for men, women, and children. After their recitation the corpse is laid in the grave with the head northwards. The grave is then roofed over with bamboos or planks, over which some thatching grass (झलास *jhālās*) is laid, which is plastered over with mud. It is then filled up with dried earth, every member of the funeral procession assisting in doing so. This is called मिट्टी देव *mitti deb*. Before the party leave the grave-yard, alms (खैरान *khairāt*) are given to beggars. The man who digs the grave is a जोनियाँ *noniyān*, and his fee is known as कबर खोदाद (قبر کھوداي) *kabr khodāi*.

1432. For four days after the death nothing is cooked in the deceased's house, and the family is supplied with food by the relatives. On the third day the brethren all assemble in an open place and $1\frac{1}{4}$ or $2\frac{1}{2}$ *seers* of gram, some flowers, betel-leaf, and *sharbat*, are taken there. Each man then takes up a grain of the gram, and after reciting a benediction over it drops it on a cloth spread for the purpose. The benediction is called दरूद (درود) *darūd*. They go on doing this till all the grain is exhausted. It is then given to beggars, and the *sūra* or chapter of the Qur'an entitled *qul huwa-l-lāhu* is read. Each one then drinks *sharbat*, takes betel-leaf, and the meeting separates. This ceremony is called by the educated कुल (قل) *kul*, from the first word of the title above quoted. By the ignorant it is called पान फूल *pān phūl*. It is the conclusion of the funeral ceremonies.

CHAPTER X.—CEREMONIES AT PLOUGHING AND SOWING
AND TRANSPLANTING.

1433. In the south-west on the first day of ploughing the villagers scatter rice-flour over the plough and yoke. This ceremony is called समकृत *samahut*. A similar ceremony is the हरमहूरत *harmahūrat* north of the Ganges, also called समकृत *samahut* in Tirhut, in which a handful (मूठ *mūth*) of grain is thrown into the field at the north-west (भण्डार *bhandār*) corner. In South Munger the plough is worshipped. The ceremony is called हरमोतर *harmotar*, and in it a vessel of water is poured over the plough in the name of the earth-goddess धरती माइ *dharti māi*.

1434. In South-West Shahabad the मूठ पूजा *mūth pūja* is the feast at the time of commencement of sowing. The villagers give handfuls of grain to the herdsman and watchman. It is also called दिहवार पूजा *dihvār pūja*. In South Bhagalpur the मूठ पूजा *mūth pūja* consists in the cultivator feeding his labourers on rice and milk. On the last day of sowing broadcast, a small quantity of seed is brought back to the homestead and shut up in an earthen pot (कूड़ा *kūra*), after which food of extra quality is prepared. This is called generally कुंडमुन्दन *kunmūdan* or कुंडमूनन *kunmūnan*; also हरसोधन *harsodhan* in Champāran.

1435. On the first day of transplanting rice a feast is given. This is called पहिरोप *pahirop* in Patna, and पहिरोपा *pahiropa* in the south-east. In East Tirhut it is खेत भोज *khet bhaj*, or खेत भोजनी *khet bhajni*. South of the Ganges on this occasion the cultivators face the east and plant five rice seedlings (मोरी *mori*). This is called पंचाईत *pañchāith* in Shahabad, and पाँचैती *pañchānti* elsewhere. On the same occasion in South Bhagalpur wine, milk, fried grain, and oil are offered to the gods who protect the field from blights and mildews. This ceremony is called गोछी *gochhi*. In South Munger on this occasion a deity of the मुसहर *mushar* caste, named मुकुटवा *Murkatua*, is worshipped. The legend about him is that a cultivator once sent this man, who was his labourer, home from the fields to get some seedlings. On the labourer's return the cultivator observed a spot of vermilion (सेहर *senur*) on his forehead, and concluded that he had been debauching his (the cultivator's) daughter, who was at home at the time, and had given the seedlings. The man was quite innocent, but the cultivator in a rage killed and hid him in the earth. He is hence worshipped as a martyr, especially by his caste-fellows.

North of the Ganges, on the first day of transplanting a feast is given to the neighbours. This is known as गवा *gawa* or गावा *gāwa*, and to give it is गवा लेब *gawa leb* or गवा लगारब *gawa lagāëb*.

1436. The feast at the conclusion of rice transplanting is औंजली *auñli* in South Bhagalpur, बनउसरा *banusra* or बनुसार *banusār* in Gaya, and उहारी *uchhāri* or बनउखाय *banukhāo* in Patna. In Sāran, when the transplanting is over, a handful of seedlings is planted with ceremony in a corner of the field. This is called केना डेहरी *kena dehri*.

1437. In planting sugar-cane, before commencing, the direction of the wind is tested to judge of the probability of rain. This is called पवन परिच्छा *paban parichchha* in the north-west. The day on which the planting of this crop, as well as of the spring crop, is commenced, is called मूठ *mūth*, and when it has come they say मूठ लागल *mūth lāgal*. When the planting is concluded five long canes are planted in the middle of the field. This is called पंचउख *panchukh* or पंचौख *panchāukh* north of the Ganges, and पचखौड़ *pachkhāūr* south of it.

CHAPTER XL.—HARVEST CEREMONIES.

1438. When the crops are cut, some of the new grain is taken home and eaten with certain ceremonies. This feast is known as नेवान *newān* or नेवानी *newāni*, or to the south-east as नेमान *nemān*. When the grain is collected on the threshing-floor, a cake of cowdung is placed on the top of the heap to avert the evil eye (see § 839). South of the Ganges worship is also done to the village deity or दिहवार *dihvār*. A similar worship in South Bhagalpur to propitiate ghosts is called दानो पूजा *dāno pūja*.

1439. The ceremony of the first cutting of the sugar-cane takes place, south of the Ganges, on the festival of the देव उठान *deb uthān* or देवउठान *deothān*. This takes place on the 11th of the bright half of Kātik (*i.e.*, early in November), and is said to be the day on which Vishnu wakes from his four months' sleep. In South-West Shahabad, on this day, the villagers tie a few canes together by the leaves, and place a neck-ring (हंसुली *hansuli*) on the top. They then pour perfumes over it, take the neck-ring away, and commence cutting. When the crushing of cane is begun a ceremony is performed, called पिठार *piṭhār* in South-West Shahabad, समउत *samahut* in the rest of that district, पेटावन *petāvan*

in Patna and Gaya, and पचघन *pachghan* in the south-east (see also § 299).

1440. In Shahabad, on the first day of crushing cane, the villagers take some juice home to cook with rice. This dish is called रसजाउर *rasjāūr*. The ceremony at the first boiling of the juice is सिठाइ *mithāi* in the south-west, and सिरन्नी *sirni* in Patna and Gaya. A similar worship of a god, who is called कोइला माता *Koila Māta*, exists in the south-east. This god exists elsewhere as a deity protecting wells.

CHAPTER XII.—MISCELLANEOUS.

1441. Among the lesser known festivals may be mentioned the following. The ऊरस *ūras* or चिरागा *chirāga* is, south of the Ganges, a festival held in honour of the Musalman saint मखदूम शाह *Makhdūm Shāh*. It takes place on various dates in different places, *e.g.* in Patna City it takes place in the month of *Bakrā'ud* (about December), and at other places in *Bārāh wafāt* (about March). मखदुमाना *makhdumāna* is a rite performed in his honour by landlords.

1442. The छठ बरन्त *chhath bart* is a Hindu festival in honour of the sun held on the 6th of the light half of Kātik (early in November). The दवान पूजा *dawāt pūja* is held by men of the Kayasth caste on the 12th of the light half of Kātik (*i.e.*, the day but one after the *diwālī*). On this day they worship their inkstands and will not touch pen and ink.

1443. In the north and east, on the 3rd Bhādoñ (August–September) occurs the तीज *tij*, on which women fast a day and night in honour of the goddess पार्वती *Pārvatī*, and eat सत्तू *sattu* (ground parched grain) next day. On the last day of Bhādoñ occurs the अनन्त *anant* or अनन्त *ant*, on which day both men and women fast. In the same tract the बहुरा *bahura* is a festival on which the women eat सत्तू *sattu* with sugar and clarified butter.

1444. The अखरन्तीज *akhartij* in Patna, अखरन्तिजिया *akhartijiya* in Gaya, and अखरन्ती *akhartit* in South-West Shahabad, is the feast on the 3rd of the light half of Baisākh (early in May), on which the obligations of the spring harvest are cleared off. In South Bhagalpur it is called अहै निरन्तिया *achhai tirtiya*.

1445. On the 5th of the light half of Sāon (early in August) occurs the feast of the नाग पञ्चमी *nāg panchami*, also known as लाग पञ्चमी *lāg panchmi* in North-East Tirhut, नकण्पाँचे *nakpānche* in Shahabad, नगण्पाँचे *nagpānche* in Patna and Gaya, and लगण्पाँचे *lagpānche* in the south-east. On this festival the women mark their houses with lines of cowdung, and worship सेसनाग *sesnāg* (the Serpent of Eternity) with milk and parched grain (लावा *lāva*). On the गोबर पाँचे *gobar pānche*, which falls on the 5th of the dark half of the same month (late in July), the same god is often worshipped in Patna instead of on the former festival. This is called बेहरा पाँचे *behra pānche* in South Bhagalpur.

1446. गोधन *godhan* is a woman's rite in which they make cow-dung figures of scorpions, snakes, &c., and beat them. To the south of the Ganges, in Bhādoū (August-September), the women fast for twenty-four hours and make cowdung figures of Ganes and lay brambles (भाड़ भूड़ *jhār jhūr*) in the court-yard, saying the words अप्पन करम्म भैयक धरम्म भाड़ भूड़ सुविच्चावे ही *appan karm bhaiyak dharm jhār jhūr ghusiāwe hī*, an incantation which literally translated means, 'I cause my own fate and my brother's virtue to enter the bramble.' This incantation is supposed to benefit the speaker and her brother in some mysterious way. A similar ceremony is called करन्ना धरन्ना *karma dharna* in South Bhagalpur.

1447. The जित्तिया *jiṭṭiya* to the west and the जित्तिया *jiṭṭiya* to the east is a fast and worship performed by women on the 8th of the dark half of Kātik (late in October) for the benefit of their children.

1448. In Patna the festival of the *holi* festival (full moon of Phāgun or middle of March) is distinguished by the custom called लुकारौ *lukāri* or लुकवारी *lukvāri*. In this, at night, the village children throw lighted torches across the boundaries of the village into the neighbouring village. This is supposed to be lucky for the village which throws, and unlucky for the village which receives, and is a source of frequent fights.

1449. On the day between the 15th of Chait and the 15th of Baisakh (about the 15th of April) when the sun enters the sign of the Ram (मेख *mekh*), it is customary to feed Brāhmins with सत्तू *sattu* (ground parched barley), टिकोड़ा *tikorha* (immature mangos), and water, and to give alms. This feast is called the सत्तूआइन *sattuāin* or सत्तूआनी *sattuāni*. In South Bhagalpur this festival is held on the last day of Chait, *i.e.*, the last day of the

Bangālī year. On the following day there is in Tirhut a curious festival, called the जूड़ सीतल *jūr sital*. The people bathe in water drawn the previous night and eat food cooked at that time, after worshipping सितला देवी *Sitla Debī*, the goddess of small-pox. Then from morning till noon all classes, rich and poor, cover themselves with mud, and shower it on all whom they meet. No one is free from this mud bath. In the afternoon the people go out with clubs and hunt jackals and hares and whatever animal they can find in the village. On their return home they boast of their valour in having killed this and that jackal, and the phrase जूड़ सीतलक सिपाही *jūr sitalak sipāhī* is used like मोहरम के सिपाही *moharram ke sipāhī* to signify a braggard.

CHAPTER XIII.—ARBITRATIONS, OATHS, &c.

1450. A body of arbitrators is पंचाइन *panchāit* to the north and west. In Patna and Gaya it is पंचीत *panchit* or पंचेता *pancheta*, and in the south-east पंचैती *panchaitī*. The head arbitrator is called सरपंच *sarpanch*, also south of the Ganges सरन्दार *sardār* or सन्तौ *mahton*. In Shahabad he is also called सन्धान *muhān*, and in South Bhagalpur मँड़ड़ *maūrar*. A caste assembly is चटार *chatāi* (*lit.* a mat), or पङ्गत *pangat* (*lit.* sitting in a row), and its head arbitrator परधान *pardhān* or मानजन *mānjan*. In Shahabad the man next to the chief is called the खड़ीदार *chharidār*.

1451. When one party in the case challenges the opposite party or a particular person to an oath, the phrase used is हसर करब *nasar karab*; also डारब *dhārab* in Patna, Gaya, and the south-east. The oath may be on the ammonite (सालग्राम *sālgām* or सालिग्राम *saligrām*), a copy of the Sanskrit हरिवन्स *harivans*, or on Ganges water (गङ्गा जल *ganga jal*). When Ganges water is placed in a copper vessel with some leaves of the holy basil (*Ocimum sanctum*), the oath is said to be by तुलसी ताँबा *tulsi tāmba*. Or a man may lay his hand on his son's head (बेटा का सिर पर हाँथ धै के *beta ka sir par hānth dhai kae*), in which case his son is supposed to die within a year if he tells a lie, or he may touch a Brahman's legs and swear by them (ब्राह्मन के गोर छू के *Brāhman ke gor chhu kae*). In Shahabad one form of oath current is to pour forth some country liquor. This form is known as मदार्न *madāin*. The oath taken on a cow is

known as गौ किरिया *gau kiriya*. The man who swears by this oath sometimes holds the animal's tail, and sometimes simply touches it. In these cases the man before swearing bathes and puts on new clothes. North of the Ganges the गुरुड़ा *gurura* is a circle drawn on the ground in which the man who takes the oath stands, or from which he takes the thing claimed. The belief in these oaths is, throughout the country, very genuine, but perjury is sometimes attempted. One common trick when swearing with one's hand on one's son's head is to substitute some one else for the son. The writer remembers in the year 1879, when he was in camp in Darbhanga district, a curious incident. License-tax assessments were being held, and one well-known money-lender offered to swear on his son's head that he lent no money. The challenge was accepted, and the oath taken. Curiously enough the son was next day seized with what was said to be cholera, and the man came to the writer, and insisted on his name being written in the highest class of assessesees. This was done. It is satisfactory to know that the son recovered. Bābhans are popularly supposed to have little fear of the sanction of an oath, as witness the following proverb,—बील, सुत, हरिबन्ध लै, बीच गङ्गाक धार, प्रतेक लै बाभन, नँ ना करह इतिबार *sīl, sut, haribans lai, bīch gangāk dhār, pratēk lai bābhan tañ na karah itibār*, If a Bābhan swear by the ammonite, his son, the Haribans, and in the midst of the Ganges,—don't believe him.

1452. To excommunicate from caste is डका (or डका तमाकू) बन्द करब *hukka (or hukka tamākū) band karab*. It is also कुजात करब *kujāt karab* or पंचादत सँ काट देब *pañchāit sēñ kāt deb*. The headman of a caste is मुखिया *mukhiya*, चौधरी *chaudhri*, सरदार *sardār*, or मानजन *mānjan*. Amongst the Telis and Chamārs he is also called महन्तों *mahnton*, महन्तर *mehntar*, or (in South-East Tirhut), महँड *mañṛar*.

CHAPTER XIV.—MISCELLANEOUS SUPERSTITIONS.

1453. A wizard is ओभा *ojha* or जादूगर *jādūgar*. Other names also used are सोखा *sokha* in South-West Shahabad, गुनी *guni* in North-East Tirhut, डैया *ḍaiya* in Patna, भगत *bhagat* in Patna, Gaya, and the south-east, and also भगतिয়া *bhagatiya* and चटिया *chatiya* in South Munger. His enchantments are जादू *jādu* or ओभाइ *ojhāi*, also भगन्ताइ *bhagntāi* in South Bhagalpur. A witch is डारन *dāin*.

1454. An omen is सगुन *sagun*, and also north of the Ganges शगुन *shagun*. A good omen is अच्छा सगुन *achchha sagun*, or in Shahabad

सुलभ सगुन *sulabh sagun*. An evil omen is कुसगुन *kusagun*, also in the north-west बद्गुन *badshagun*, and in Patna and Gaya नहस *nahas*. In East Tirhut it is असगुन *asgun*. Other names are कुभारन *kusāit* (an unlucky time) and कुजात्रा *kujātra* (an unlucky starting).

1455. There are a vast number of village gods (ग्राम देवता *grām deotā*) worshipped throughout the province. The principal amongst them will shortly be mentioned. A काली अस्थान *kālī asthān*, also called देवी अस्थान *debi asthān* or देवी थान *debi thān*, which is a mound in honour of Kālī, the wife of Shiva (सिव *Sib*), is generally erected outside each village. In Tirhut under the village *pīpal* tree there is generally a mound, decorated with clay images of the principal personages in the epic connected with him, erected in honour of the Salhes who is mentioned in the following list. This is called a सल्लेस अस्थान *salhes asthān*. The mound erected to a deceased Brahman or holy man is generally called a बरहम अस्थान *barham asthān*.

1456. The following is a list of the principal village deities worshipped in Bihār. The more well-known deities, such as सिव *Sib*, महादेव *Mahādeb*, बरहम *Barham* (*Brahma*), or क्रिष्ण *Krishn*, are omitted. It will be observed that some of them are demons, who are worshipped in order to propitiate them.

अमता भवानी *Anta Bhavāni* or अम्बिका भवानी *Ambika Bhavāni*, a form of Debi worshipped in Sāran.

कारु बीर *Kāru Bīr* or कारु दास *Kāru Dās* (south), also कलुआ बीर *Kulua Bīr* (Patna), worshipped by Doms and Dusādhs.

कुल देवता *Kul Deotā*, the family god.

कैतुक गोसाँई *Kaituk Gosāñī*, worshipped in South Bhagalpur by Dusādhs.

कोइला माता *Koila Mātā*, the goddess of a well spring, worshipped generally.

कोदर कट्टा *Kodar Kattu*, worshipped by Doms in South Bhagalpur.

कोल *Kol*, worshipped in Gaya.

खाजे खिदर *Khāje Khidar*, the patron god of the boatman (मलाह *malāh*) caste. He is also often confused with a similar female deity गङ्गा माई *Ganga Māi*. Musalmān women fast on every Thursday in the month of Bhādoñ (August-September) and call the fast खाजे खिदर का रोजा *khāje khidar ka roja*.

खेती भवानी *Kheti Bhawāni* (Patna and south-west), worshipped by Koiris when they plant and cut their vegetables. In Patna a Musalmān vegetable-seller (कुंजड़ा *kunjra*) worships राम ठाकुर *Rām Thākur*.

गोबन्नाद राउत *Gobnāi Rāūt* (north-west), a deified cowherd worshipped in Sāran and Champāran.

गोरैया *Goraiga* or गोरैया *Gorea*, worshipped generally south of the Ganges, especially by Doms and Dusādhs; also called गोरिया *Goriya* (Patna).

घाटों *Ghāton*, worshipped in South Bhagalpur by Dusādhs.

चतावन *Chatāvan* (Patna), worshipped by Doms and Dusādhs.

चिरन्कुटवा पीर *Chirkutwa Pīr*,—see दिहवार *Dihwār*.

चुड़ड़ माल *Chuhar Māl*,—see सल्लेस *Salles*, worshipped in the south-east by Dusādhs.

चोहट *Chohat*, worshipped by Doms and Dusādhs.

जगन्द्धमा *Jagdamma*, the goddess of small-pox, worshipped in Patna and the south-east by Dusādhs.

जलासेन *Jalāsen*, the protector of bearers, worshipped in Sāran.

जौहन्री बरन्म *Jauhri Barm*, worshipped in Sāran.

झुन्की बीर *Jhunki Bīr*, worshipped in Gaya.

डमरन्डाक *Damardāk* (south), worshipped by Doms and Dusādhs.

डाक *Dāk*, worshipped in Patna, Gaya, and South Munger.

दिहवार *Dihwār* (generally), also (Sāran and South Tirhut) चिरन्कुटवा पीर *Chirkutwa Pīr*. This is a very generally worshipped deity. There is supposed to be a separate one for each village. Every one who passes by throws a piece of cloth on his image.

ढेलन्हा पीर *Dhelha Pīr* (north) or ढेलन्हा गोसाँई *Dhelwa Gosāñī* (south), in whose honour a heap of earth is erected on the road-side, to which every passer-by adds a clod. He protects wayfarers.

देबी *Debi*, the popular name of the goddess Durga.

धरन्मन्नाथ *Dharmnāth*, an incarnation of Sib, worshipped in Sāran.

नाएक साहेब *Nāek Sāheb*, worshipped in Patna.

नाग *Nāg*, the snake god. Worshipped generally. In Sāou (July–August) crowds of women calling themselves his

wives (नागिन *nāgin*) go out begging for 2½ days, during which period they neither sleep under a roof nor eat salt. Half the proceeds of the begging are given to Brāhmins, and the other half invested in salt and sweetmeats, which are eaten by the whole village. During the expedition several characteristic songs are sung, some of which have been published by the Asiatic Society of Bengal.

महथिन दाइ *Mahthin Dāi*, worshipped in the south-west.

पद्दास बर *Pahās Bar* (Patna and Gaya), worshipped by Doms and Dusādhs.

पाँचो पीर *Pāncho Pīr*, the five saints named गाजी मीयाँ *Gāji Miyañ*, हठीला *Hathīla*, परिहार *Parihār*, सहजा माइ *Sahja Māi*, and अजब सालार *Ajeb Sālār*. They are worshipped by Musalmān drummers (डफाली *daphāli*), who during an outbreak of cholera act as village Musalmān priests. They go about, beating drums, with an iron bar wrapped in red cloth and adorned with flowers, which represents गाजी मीयाँ *Gāji Miyañ*. They are paid in kind by the people at whose doors they stop and drum. A पाँचपिरिया *pañchpiriya* is a Hindu who worships Musalmān saints. In Shahabad these five saints are worshipped conjointly with three others, as mentioned in the following verse :—

अमना सती, पाँचो पीर, लँगड़ा तार, सोबरना तीर *Amna Sati, Pāncho Pīr, Langra Tār, Sobarna Tir*.

Langra Tār is simply a crooked wire which is worshipped. *Sobarna Tir* means the banks of the river *Sobarna*.

पारस नाथ *Pāras Nāth*, worshipped by bankers (महाजन *mahājan*).

फूल डाक *Phul Dāk* (Gaya), worshipped by Doms and Dusādhs.

बख्तौर *Bakhtaur*, a deified cowherd worshipped in South-East Tirhut.

बँदौतनी *Bandautni* (Gaya), worshipped by Doms and Dusādhs.

बँदौत *Bandaut* (Gaya), worshipped by Doms and Dusādhs.

बन्नी *Banni* (south-west), worshipped by Doms and Dusādhs.

बरन्द्वनिथा *Barduaniya*, worshipped in Patna.

बरहम देव *Barham Dev*, worshipped in Gaya.

बसावन कुँवर *Basāwan Kuñar*, worshipped in Gaya.

बहोड़ *Bahor*, worshipped in Patna and South Munger by Dusādhs.

बिदेसी बरज्ज *Bidesi Barj*, worshipped in Sāran.

बिसहन्ना *Bisahra*, worshipped in North-East Tirhut.

भैरव *Bhairab* or भैरो *Bhairō*, worshipped by cultivators in the south-east.

मकार बीर *Makār Bīr* (north and east),—see § 299.

मनसा राम *Mansa Rām* (Patna), worshipped by Doms and Dusādhs.

मनानो दानो *Manāno Dāno*, worshipped by Doms in South Bhagalpur.

मनुष देव *Manus Deo* (north and west), worshipped by Doms and Dusādhs.

मल्लदानो *Maldāno* (south), worshipped by Doms and Dusādhs.

मसान *Masān* (Patna), worshipped by Dusādhs and Doms.

महन्माया *Mahmāya*, the goddess of small-pox.

महाबीर *Mahābīr*, a form of Hanumān, the monkey-king who befriended Rām.

माता दाद *Māta Dāi* or सितन्ली *Sitli*, the goddess of small-pox.

मीर फजुला *Mīr Phajula*, a Musalmān saint worshipped in Sāran.

मेघू डाक *Meghu Dāk* (Patna), worshipped by Doms and Dusādhs.

मैया *Maiya* (Patna and south-east), worshipped by Mushars, Dusādhs, and Doms.

मोती राम *Moti Rām*, brother of सल्लेस *Salles* (*q.v.*), and worshipped in the south-east by Dusādhs.

रघुनी डाक *Raghuni Dāk* (Patna), worshipped by Doms and Dusādhs.

रघू *Raghu*, worshipped in South Bhagalpur by Dusādhs.

राम ठाकुर *Rām Thākur*, worshipped in Patna and the south-east. See also खेती भवानी *Kheti Bhawāni*.

राम बीर *Rām Bīr* (Patna), or राम गोसाँई *Rām Gosāiū* (Gaya), worshipped by Dusādhs.

राह *Rāh* or (North-East Tirhut) राहु *Rāhu* is a demon worshipped by Doms and Dusādhs. The ceremonies are a kind of fire-worship, in which the devotees run along a trench filled with blazing coals.

लीला डोम *Līla Dom*, worshipped by Doms in South Bhagalpur.

सनिचन्दा *Sanichra* (south-west), a god worshipped by vegetable-sellers (तुरन्दा *turha*).

सलखो *Salkho* (south-west), worshipped by Doms and Dusādhs.

सल्लेस *Salles* or सल्लेस *Sales* (south and east), worshipped by Doms and Dusādhs. He was a great hero and the first watchman. He fought a battle with चुहड़ माल *Chuhar Māl* of Mokāma, who was the first thief. A famous epic concerning him is current in Tirhut, and has been published by the Asiatic Society of Bengal.

सहजादी मार *Sahjādi Māi*, worshipped in the south-west.

सिंगेसर *Singesar*, worshipped in North-East Tirhut.

हरिराम बरन्म *Harirām Barm*, worshipped in Sāran.

हरिहर नाथ *Harihar Nāth*, in Sāran, at Sonpūr.

1457. A spell or charm is गुन *gun* or मन्त्र *mantr*. टोटका *totka*, टोटमा *totma*, or टोना *tona*, are spells or charms generally with an evil object. In Shahabad they were टोटरम *totram*; in Patna and Gaya they are optionally उत्तारा पतारा *utāra patāra*, and in South Bhagalpur निंगन्धा खोरी *ninggha chhori*. The जिजा दान *jija dān*, जिबन्दान *jib dān*, or बलिदान *balidān*, is an animal, &c., sacrificed to काली *Kālī* as a kind of scapegoat. In cases of sickness various articles are exposed in a saucer at a cross-road. This custom is supposed to communicate the disease to the first person who touches it, and is called जोग *jog* or जोग टोन *jog ton*, or in South Bhagalpur ओम्प टेस *ojh tem*. The contents of the saucer vary with the disease demon to be propitiated. There are generally some red ओढौल *orhaul* (*hibiscus*) flowers, some sand, grain, and yellow cloth. If a ghost भूत *bhūt* has to be propitiated, wine, or even a fowl, is laid there. In cases of small-pox, the cloth with which the sores were dressed is frequently put out, which often makes the superstition about communicating the disease a lamentable reality. In South-East Tirhut an oblong mound studded with flags to avert cholera is called आंसरिक *āsrik*. The खटोला *khatola* (north of the Ganges) is a miniature bedstead hung on a tree as a propitiatory offering.

1458. The following is a list of some of the various demons, ghosts, and other supernatural bogies believed in in Bihar. Those which are worshipped, and which hence have been included in the former list, are omitted.

आगि बैताल *Āgi Baitāl* or **अगिया बैताल** *Agīya Baitāl*, a hideous demon which lurks in trees, lives on dung beetles, and seizes wayfarers by night.

कौचिन *Kōchin* (south), a kind of Lamia. She assumes the shape of a beautiful woman, and visits and seduces any man whom she may meet in a lonely place. The man dies within a few months of his yielding to the temptation. She has feet back to front, *i.e.*, toes behind and heels in front. Hence the wise may recognize her.

घोघर *Ghoghar* (north-west), a ghost invoked to frighten children.

चटुआ *Chatua* or **चटुआ** *Chahta* (north-west), **चटना** *Chatna* (north-east), a vampire who drinks up the milk of cows and women. In South Bhagalpur he is called **चोर मटका** *Chor Matka*.

चुड़ैल *Churail*, also (in Shahabad) **बहरिया** *Bahariya*, an evil spirit which assumes the shape of a bird and sits on the roof of a house which contains a pregnant woman. This injures the child.

जिलैया *Jilaiya* or **जलवैया** *Jalvaiya* (south), or (South Bhagalpur) **मरचिड़िया** *Marchiriya*, a fiend which takes the shape of a night bird, and is able to suck the blood of any person whose name it hears. Hence women are very careful about calling their children by name in the night time. If it fly over the head of a pregnant woman, the child born will be a weakling. Such a child is called **जिलवैया के छुचल** *jalvaiya ke chhūal*.

जिन *Jin* (north), a ghost, goblin, genius, 'djinn.'

डूबा *Dāba*,—see **बूड़ा** *bāra*.

धोकर कमवा *Dhokar Kaswa*, a man with a bag who carries off naughty children.

नेकी बीबी *Neki Bibi* (Gaya and south-west), a ghost invoked to frighten children.

पनडूबी *Pandūbi*,—see **बूड़ा** *bāra*.

बरम पिचास *Barm Pichās*, a kind of ghost or goblin.

बूई *Būi* is a ghost invoked to frighten children.

बूड़ा *Bāra*, **डूबा** *Dāba*, or **पनडूबी** *Pandūbi*, a water-demon, who drowns travellers.

बापेर *Bauper* (north), a kind of ghost or goblin.

भाङ्कुर *Bhākur* (north-west), a ghost invoked to frighten children.

भूत *bhūt*, a ghost or goblin generally.

भोकसन्वा *Bhokasva* (south), a ghost invoked to frighten children.

मनुसन्देश *Manusadeba* (north), a kind of ghost or goblin.

मरन्चिड़िया *Marchiriya*,—see जिलन्वैया *jilwaiya*.

माँचौ *Māñōñ* (north), a ghost invoked to frighten children.

मिमियाइ के तैल *mimiyāi ke tel*, a kind of bitumen brought from Persia and elsewhere. It is said to be extracted from the heads of coolies who emigrate to the colonies, by hanging them head downwards and roasting them over a slow fire. The threat of extracting it from the head of a child is therefore an active deterrent.

राकस *Rākas*, the will o' the wisp; it breathes fire and misleads travellers, but it also lives in the fields, and where it resides grain is produced in abundance.

सुखण्डा *Sukhra* (north), also सुखैनी *sukhaini* (North-East Tirhut), a vampire which sucks up children's blood.

हाक *Hāū* (Patna), or डम्मा *humma* (South Bhagalpur), a ghost invoked to frighten children.

1459. The उत्सर्ग *utsary*, and also (in Tirhut) काननोत्सर्ग *kānansary*, is the emblematical marriage of a grove to a well, without which preliminary observance it is unlawful to partake of the fruit. The बिरखोत्सर्ग *birkhotsary*, and also (in Tirhut) the वैदिक *baidik*, is the ceremony of marriage performed in the name of a bullock let loose on the 11th day of mourning for a near relative. The जलोत्सर्ग *jalotsary* is the emblematical marriage ceremony on completion of a well or tank. It is married to an image erected close by. In case of a pond it is also called तरागोत्सर्ग *tarāgotsary*, and on completion of a well कुपोत्सर्ग *kupotsary*. The latter is called in South Bhagalpur रूप जग *kūp jag* or कुइयाँ दान *kūiyāū dān*. बाटोत्सर्ग *bātotsary* is the ceremony on the completion of a road. No marriage is in this case performed.

1460. Water brought from a sacred river, spring, or place of pilgrimage तीरथ (*tīrath*), is much used in religious ceremonies, and is carried by men called कमरपन्थु *kamarpanthu*. They are also called कंवारन्थु *kamwārthu* in South-West Tirhut and कमरथुथा *kamrathua* in South-East Tirhut.

DIVISION XIII.

TRADE, MONEY-DEALING, AND ACCOUNTS.

CHAPTER I.—TRADE AND BAZAR ACCOUNTS.

1461. *Trade* is लेन देन *len den*, महाजन्मी *mahājñi*, कारबार *kārbār* or कारोबार *kārobār*, बेवन्दार *beohār*, बेयापार *beyāpār* or बेसोपार *beopār*, or बनिज *banij*. In Patna City it is also बेवन्दारगत *beohargat*. *Exchange* or *barter* is अदन्लई बदन्लई *adlai badlāi*. A *money-lender* is महाजन *mahājan*, साह *sāh* or साहकार *sāhukār*, or बेवन्दारिया *behvāriya*. He is also called in the country बनिया *baniya*, and in South-West Shahabad साव *sāo*. In Patna City he is called कारोबारी *karobāri* or धनी *dhanī*. A *banker* is कोठीवाल *kothīwāl* or सराफ *sarāph*. A *borrower* is रिनिहा *riñiha*, खदुक *khadduk* or खदुका *khaduka*, or असामी *asāmi*. In South Munger he is also called मुजेरा *mujera*, in South Tirhut बनिघौटा *baniyāuta* and धारनिक *dhārnīk*, and in South Bhagalpur खानब *khātab*. In Patna the words करज खौक *karj khauk* and करज खोर *karj khor* are also used.

1462. An *account-book* is बही *bahī*. A trader's account-books are called collectively बही खाता *bahī khāta*. जाफर *jākar* in Gaya is a record of cloth sales kept by cloth-merchants. Each page of the account-book is called पन्ना *panna*, and also in North-East Tirhut पत्ता *putta*.

1463. The following are the books usually kept by village money-lenders:—

- (a) The रोजनामचा *rojnāmcha*.—This is the *day-book*. The left hand or credit side of the page is known as जमा *jama*, and the right or debit side as नाँव *nānw* or नाम *nām*.
- (b) The रोकड़ बही *rokar bahī*—Mr. Crooke's description of this is equally applicable to Bihār. It is exactly the same as the रोजनामचा *rojnāmcha*. There is only this difference,

that it is balanced after each transaction. For example, the book shows Rs. 1,000 on the credit side; Rs. 100 are disbursed on a certain account. This is entered on the debit (बाकी *bāki* or नाँव *nānw*) side, and the book is balanced showing Rs. 900 still to credit. This is called रोकड़ बाकी *rokar bāki* or बाकी तहबील *bāki tahbīl*, and is again brought forward to credit. North of the Ganges it is called फाजिल *phājil*. A man who carries on several distinct trades keeps up a separate रोकड़ बही *rokar bahi* for each.

- (c) The लेखा बही *lekha bahi*, the खाता *khāta*, or खाता बही *khāta bahi*.—This is the *ledger*, and is made up as time allows from the रोजनामचा बही *rojnamecha bahi*. It contains each creditor's or debtor's account separately, with a reference to the page of the day-book on which each item has been entered day by day. Some traders keep up a separate खाता बही *khāta bahi* for each of their trades or speculations, others have only one general one.
- (d) There is also the जमाखरन्च *jamakharch*, which is an abstract of the day-book, and is hence also called a खतियौनी *khatiyauni*, and shows the totals of receipts and payments on each page.

1464. Small traders generally only keep up the first of these books, —the रोजनामचा *rojnamecha* or day-book. Very small traders do not even keep this. They have a separate slip of paper containing each customer's account, and called चिट *chit*, चिट्टा *chittha*, or चिट्ठी *chitthi*, or पुरजा *purja* or पुरजी *purji*. In South Munger it is called सरखत *sarkhat*.

1465. Large traders, such as those in the city of Patna, with whom this work has nothing to do, keep up all the above four books. For the sake of completeness, the following information, founded on that given by Elliot in his Glossary, is added. Quoting Elliot's words (with the necessary alterations to suit local variations): "The page (of an account-book) is divided into two equal parts, called in Patna रेकाना *rekāna*: each of these is again divided into two रकन *rukan* or रकन *ruku*. The (first or) right-hand रेकाना *rekāna* is called the हागो *hāgo*. The first right-hand quarter (some say half) of the left-hand रेकाना *rekāna* is called सीरा *sira*, and the remaining portion is called in Patna City

इरादा *irāda*, and elsewhere पेटा *peta* or (in North-East Tirhut) पेट *pet*. The सीरा *sira* contains the sum finally brought to account after the necessary deductions have been made from the gross amount in the पेटा *peta* and हाशो *hāsho*." In reading the above, it should be remembered that it refers to accounts kept in the Persian character. When kept in the *mahājni* character, the terms for right and left must be reversed.

CHAPTER II.—ACCOUNTS BETWEEN LANDLORD AND TENANT.

1466. These accounts are not usually kept in bound books, but on separate slips of paper, kept together in packets by a paper tape, called तबलक *tablak* or कैदक *kaidak*.

1467. A tenant's receipt for rent is known as रसीद *rasīd* or दाखिला *dākhila*, and in North-East Tirhut कबज *kabaj*.

1468. The system of accounts differs according as the rent is paid in kind or in cash. Hence two sets of accounts are kept up in a landlord's office. They are the following :—

(a) Accounts of rents paid in kind—

1. खसरा दानाबन्दी *khasra dānābandi*.
2. खसरा बटाइ *khasra butāi*.
3. मोफरीद *mophrīd*.
4. लगित *laggit* and वासिल बाकी *wāsil bāki*.
5. तिरिज जिनिस्वार *tirij jinīswār*.
6. सियाहा *siyāha*.
7. हिसाब बिकरी गल्ला *hisāb bikri gulla*.

(b) Accounts of rents paid in cash—

8. खसरा *khasra*.
9. मोफरीद *mophrīd*.
10. लगित *laggit* and वासिल बाकी *wāsil bāki*.
11. तिरिज पटेवारी *tirij patevāri*.
12. सियाहा *siyāha*.

(c) In addition to the above, the following general accounts are kept, which are applicable to both kinds of rent—

13. मोलहकी *molhaki*.
14. दड्डा *dhaddha* or जमा वासिल बाकी *jama wāsil bāki*.

15. जमाबन्दी *jamābandī*.

16. जमाखर्च *jamākharḥ*.

1469. The word तिरिज *tirij*, met with above, means 'abstract.' In small estates, Nos. 5, 11, and 14 are often not used.

1470. The following is a brief description of the above accounts :—

- (1) The खसरा दानाबन्दी *khasra dānābandī*. This is the account paper drawn up in the field when the दाना *dāna* or estimate of the crop is being made. It contains—
 - (a) The date.
 - (b) Name of tenant.
 - (c) Quantity of land (खराजी *arājī*).
 - (d) Length (तूल *tūl*) and breadth (खरज *araj*) of the plot.
 - (e) Name of the crop (जिनिस *jinis*) thereon.
 - (f) The quantity of grain estimated.

The तिरिज नारीखन्वार *tirij tārikhṅvār* is a daily abstract of No. 1, and shows (in the case of division by appraisement) the total area of land and the quantity of grain estimated daily. The sum of all the daily entries in this paper shows the total area of lands of which the rent is paid in kind, and the produce thereof. This account is only kept when the division of the crop is by appraisement (दानाबन्दी *dānābandī*, see § 913). Some landlords, however, also keep it in the case of actual division on the threshing-floor, as a check on No. 2.

- (2) When the division is by actual division on the threshing-floor (अगोर बटार *agor batāi*, see § 914), a खसरा बटार *khasra batāi* is opened instead, containing the date, name of tenant, area, kind of crop, quantity, landlord's share, cesses, &c.
- (3) The मोफरौद *mophrūd* is the bundle of papers in which separate accounts of each tenant are entered. A separate slip of paper is kept for each tenant. It is compiled from the खसरा *khasra* (No. 1). It shows the quantity of each kind of grain belonging to him which was

estimated, date by date. The area of the land under each crop at each estimate is also given. When this is abstracted out so as to show the total area and total crop for each tenant, the abstract is called *तिरिज मोफरीद* *tirij mofhrīd*.

- (4) The *लग्गित* *laggit* and *वासिल बाकी* *wāsil bāki* are written up from No. 3, a separate slip of paper being kept for each tenant. They form a kind of ledger or personal account. The heads are as follows,—the total quantity of each kind of grain and the area of land under each. The total share claimed by all the landlords (*हाकिमी हिस्सा* *hākīmī hissā*) is then struck off. From this the shares of the other shareholders, who keep accounts separate from the landlords whose accounts we are considering, is deducted. To the remainder the cesses and other dues (*अबन्वाब* *abwāb*) are added. The total shows the quantity of grain realizable from the tenant by the landlord on whose behalf the account is prepared. This portion of the account showing the demand is called the *लग्गित* *laggit*. From the total demand the quantity of grain realized during the year is set off, and the balance, if any, is shown. The whole paper showing demand, realization, and balance is called the *वासिल बाकी* *wāsil bāki*. An abstract of the *लग्गित* *laggit*, showing under the head of each kind of grain separately the amount of crop of, and area of land under, that grain owned by each tenant, is called the *तिरिज लग्गित* *tirij laggit*. The abstract of the *वासिल बाकी* *wāsil bāki* is the *ढड्डा* *dhaddha* (No. 14).
- (5) The *तिरिज जिनिस्वार* *tirij jiniswār* is compiled from the *लग्गित* *laggit* (No. 4). It shows in one entry for each tenant the total area he has under cultivation, and the amount of each kind of crop demanded from him.
- (6) The *सियाहा* *siyāha* is the day-book of receipts and disbursements of grain. An abstract of this, called the *आवारजा* *awārja* or *वारजा* *wārja*, shows the total receipts and disbursements, date by date.
- (7) The *हिस्ब बिकरी गल्ला* *hisāb bikri gallā* is the account showing the produce of the sale of the grain received as

rent. It shows the date of sale, quantity sold, rate, and price.

1471. We now come to the accounts of rent paid in cash.

- (8) खसरा *khasra* is the paper in which the area (*i.e.*, तूल *tul* or length and अरज *araj* or breadth) as ascertained by measurement of the lands held by the tenants in a village, together with the rate per bigha or class (पट्टा *patta*) of each plot, is entered. An abstract of this shows the amount measured each day, while the measurement is going on, and is called तिरिज खसरा *tirij khasra*. This खसरा *khasra* gives only the measurement of the lands held temporarily on a cash rent, and differs from the regular खसरा *khasra* or measurement papers of a village.
- (9) मोफरीद *mophrid*.—This is similar to No. 3, *mutatis mutandis*. It shows the area and different rates of rent of the various plots held by each tenant. Each tenant has a separate slip of paper, and all lands for which cash rents are paid, whether temporarily or not, are included in it. It is compiled from No. 8 and No. 10. An abstract of it, called तिरिज मोफरीद *tirij mophrid*, shows the area of land held and total rent payable by each raiyat.
- (10) लगित *laggit* and वासिल बाकी *wasil baki*.—These are similar, *mutatis mutandis*, to No. 4. They are the ledger account of each tenant. Each tenant has a page, on which is shown the area of his plots, rate of each, rent of each, total area, and total rent. From this the shares of the other shareholders are deducted, and to the remainder the cesses and dues are added, together with the value of any rent in kind (दमाव गला *damāo galla*), due by the raiyat which has not been realized during the year. To this again the arrears of previous years are added, and the total shows the demand against the tenant. The paper thus far is called the लगित *laggit*. From the total demand is deducted the cash rent collected during the year, and the balance is struck to be carried to next year's account. The whole paper showing demand, realization, and balance is called

the वासिल बाकी *wāsil bāki*. An abstract of the लगित *laggit*, called the तिरिज लगित *tirij laggit*, shows under the head of each tenant separately the total area held and rent payable by him at each rate. The abstract of the वासिल बाकी *wāsil bāki* is the ढडा *dhadha*.

(11) The तिरिज पटेवारी *tirij patevāri* is the paper in which the name of each पहा *patta* or separate class of land in the village is entered, showing the total area, rate, and rent of each class. The total shows the total area of land held at various rates in the village. This paper is compiled from No. 10.

(12) The सियाहा *siyāha* is the same (*mutatis mutandis*) as No. 6. In this the daily receipts and disbursements in cash, including the price of grain sold, are entered. It is, in fact, a cash-book. An abstract of this, called the अवारजा *awārja* or वारजा *wārja*, shows the total expenditure day by day.

1472. The following accounts are applicable to both kinds of rent.

(13) The मोलन्दकी *molhaki* is a ledger account for each tenant, showing date by date all payments (whether in cash or kind) made by him. It is compiled from the सियाहा *siyāha*. An abstract of this, called तिरिज मोलन्दकी *tirij molhaki*, shows the total payments made during the year by each tenant. The totals of this should agree with the total of No. 12 (the सियाहा *siyāha*) on the receipt side. It hence serves as an abstract of the receipt side of No. 12, while the अवारजा *awārja* is the abstract of the disbursement side.

(14) The ढडा *dhadha* is also called the तिरिज वासिल बाकी *tirij wāsil bāki* or जमा वासिल बाकी *jama wāsil bāki*. It shows the name of the tenant; area of his holding at each rent; amount of rent; additions on account of cesses, unrealized grain rent and arrears of previous years; deductions on account of shares of other shareholders; deductions on account of cash rent realized; and balance. This paper is in fact an abstract of the वासिल बाकी *wāsil bāki* (Nos. 6 and 10). The latter shows the accounts of each tenant separately,

whereas the *दफ़ा dhadlha* shows all the tenants' accounts on one sheet of paper. This form of account is according to Field* said to have been invented by Udhmant Singh, of Nassipur, in the district of Murshidabad, in order to enable the zamindārs to represent the collections as they pleased to the Muhammadan Government.

- (15) The *जमाबन्दी jamābandī* is the paper in which the total annual demand of the village on account of rent is entered. This paper does not usually show illegal demands from the tenants. These are generally shown only in the *जमाखर्च jamakharch* (No. 16).
- (16) The *जमाखर्च jamākharch* is the final annual abstract of the financial condition of the village. It shows the total demand, realization, and balance of the year in more or less detail. The demand side shows the balance of previous year, the total demand according to the *जमाबन्दी jamābandī* (No. 15), and other items of demand (such as fines, illegal cesses, &c.) which do not find their way into the latter. The total is the grand total of the demand for the year. This demand is on the other side of the account again divided into money spent and balance. The money spent includes the portion of the realizations which are forwarded to head-quarters, and the portion of realizations spent on the village and on miscellaneous expenses. The balance is made up of realizations in hand, and for which the village official or the landlord's grain-merchant is responsible, and of unrealized demand, the latter of which is given in detail. Some landlords have two copies of this paper,—one for their own information, containing the illegal cesses, and the other excluding them, so as to allow of its production in court.

1473. In the appendix to this work are given translations of the various forms of account as kept by a Patna landlord.

* Law of Evidence, p. 670.

CHAPTER III.—INTEREST, DISCOUNT, AND COMMISSION.

1474. *Discount and commission* are generally सलामी *salāmi*. बहा *batta* is also used south of the Ganges. In Patna they are also called फिराना *phiranta*. बढ़न्ती *barhti* is a *premium*. सकररई *sakrai* is a *commission* of 3 or 6 pies per cent charged by the acceptor on accepting a bill. नकररई सकररई *nakrai sakrai* is a charge at 8 ānās per cent. on a drawer of a bill when his bill is not accepted. जाबन्ता साह जीग *jābta sah jīg* is a commission at one anna per cent. when the bill is accepted in favour of a banker. हँडियाना *hundiyanā* or हँडियावन *hundiyan van* is commission on a bill-of-exchange (हण्डी *hundi*). *Factorage*, or the commission (of one or two piee per rupee) taken by a servant on goods bought for his master is दस्तूरी *destūri*, or, more commonly, फल *phal*. दलाली *dalāli* is *brokerage*.

1475. *Interest* is सूद *sūd*. Interest in kind, paid on seed-grain, is चाघी *āghī* to the west and in South-East Tirhut. In South-West Shahabad it is अगवन *agwan*, and in Patna बाड़ा *chhāra* or कहौर *karhaur*. North of the Ganges generally it is also called सवाद डेही *savāḍ derhī*, in allusion to the rate at which the principal is lent. In the south-east it is बियाज *biyāj*. Elsewhere बियाज *biyāj* or बेआज *beāj* is interest on money, which in the south-east is सूद *sūd*. असल *asal* or मूर *mūr* is the capital lent out at interest; but in Shahabad it is also मूल *mūl*, and in the south-east सूदी रुपैया *sūḍī rupaiyā*. मोनाफा *monāpha* is profit. It is distinguished from interest (which is unlawful for them) by strict Musalmāns. Amongst others, however, the two terms are convertible. Other words for profit are बहोतगरी *barhotri* or नाफा *nāpha* in Shahabad, नफा *napha* or इनगतिफा *intāpha* to the west, इनगताफा *intāpha* in the south-east, and बचिन *bachit* in Patna, Gaya, and South Bhagalpur.

1476. पैँचा *paincha* or हथफेर *hathpher* is a loan when the exact thing is to be returned. A local variant is पैँच *painch* in South-West Shahabad. It is also called उधार *udhār*, which properly means a purchase on credit. करन्जा *karja* is a money loan. This is also called south of the Ganges करन्ज *karj*, करन्जवास *karjwām*, and पैँचा *paincha*. दसगर्दौ *dasgardān* or (amongst the educated) दस्तगर्दौ *dastgardān* is a temporary loan without interest. हथफेर *hathpher* or (in Shahabad) हँथ उधार *hanth udhār* is also used in this sense.

1477. A *debtor* is खडुका *khaduka* or असामी *asāmi*. Local names are खडुक *khadtuk* in Gaya and the south-west, मुजेरा *mujera* in Patna, and खातब *khātab* in South Bhagalpur. A defaulting dobtor is जनामार

jamāmār, also धनन्मार *thanmār* in Champāran and South-East Tirhut, मलन्मार *malnmār* in South-West Tirhut, and थैलीमार *thailimār* in South Bhagalpur. Other names are खाऊ *khāu* in Saran, खौकार *khaukār* in South-East Tirhut, and ना देहन *na dehan* in Patna. The educated say ना देहन्द *na dehand*. *Outstandings* are लहना *lahna*. A *bad debt* is गनाल खाता *gatāl khāta* in Patna and the north-west, and गयाल खाता *gayāl khāta* in Gaya and the south-west, of which गैल खाता *gail khāta* in South Munger is a variant. In South-West Shahabad it is also said to be गपनाल *gaptāl*, in Tirhut they say बूड़ल भेलै *būḍal bhelai*, and in South Bhagalpur डूबो गेलै *dūbo gelai*. When an animal or other property is *pledged for a debt*, it is called to the north-west and in West Tirhut लावन *lāvan* or लावन भावन *lāvan' jhāwan*. Elsewhere it is भरना *bharna* or गिरो *giron*.

1478. To borrow money is सूद पर रुपैया काहब (or काहि लेब, or काहि लाग्रब) *sūd par rupaiya kārhab* (or *kārhi leb*, or *kārhi lāēb*).

CHAPTER IV.—RATES OF INTEREST.

1479. A rate of interest is दर *dar*. The following are the rates of interest charged. Interest at one per cent. is रुपै सैकड़ा *rupai saikra*, at two per cent., दू रुपै सैकड़ा *du rupai saikra*, and so on:—

- (1) डेड़ा *derha*, डेओड़ा *deorha*, or in the south-east डेउहिया *deurhiya*. This is fifty per cent., e.g., a man borrows five maunds of grain at sowing time and repays 7½ maunds at harvest, without reference to the selling price at the time of borrowing or repayment. This is confined to transactions in grain.
- (2) सवार *sawāi* or सवेया *sawaiya* is twenty-five per cent. as above.
- (3) बिकरी के भाव *bikri ke bhāo* (north), or भाव के भाव *bhāo ke bhāo* (south), also असल के असल *asal ke asal* in the south-east.—In this grain is lent, and at harvest time an equivalent in grain to the real money value of the grain lent at the time of borrowing is returned.
- (4) लगानी *lagāni* is giving one rupee's worth of grain and after six months receiving back one rupee two annas worth. In South Tirhut it is also called अठरहनी *athrahni*.

- (5) पैसे रुपैया *paise rupaiya* is money interest at one pice per rupee per month. So डेढ़ पैसे रुपैया *derh paise rupaiya* is one and a half pice per rupee per month.
- (6) टकाही *takhi* is money interest at two pice or one टका *taka* per rupee per mensem. In the south-east it is also called अधधन्नी *adhanni*.
- (7) गँडन्ही *gandhi* is money interest at four pice per rupee per month.
- (8) चरधन्नी *charanni* is four annas per rupee per annum.
- (9) पचधन्नी *pachanni* is five annas per rupee per annum.
- (10) छवधन्नी *chawanni* is six annas per rupee per annum.
- (11) किल *kist* or किल बन्दी *kist bandi* is when the total of principal and interest is repayed within a stated time by fixed instalments.

1480. The first money received by a shopkeeper during the day is बोहनी *bohni*; also बोहनी बट्टा *bohni batta* in Patna and Gaya, and बनहारा *banhāra* in South Bhagalpur. In Patna City it is गँठौट *ganthaut* or गँठा *gātha*. A *pledge* or *deposit* is गिरौँ *giron* or बन्धिक *bandhik*. In Patna, Gaya, and South Munger it is गिरौँ *giron*, in Shahabad गिरौँ *giron*, in the south-west of that district गिरौँ गँठ *giron-gāth*, and in South Bhagalpur गिरनी *girmi*. पुरिया *purija*, or in East Tirhut पुरजा *purja*, is a sealed or fastened-up deposit. जाकड़ *jakar* is goods which are taken away for use, if required, at a wedding, &c. The price is fixed before hand. If the goods are used, this is paid; if they are not used, they are returned, and a pice or two per rupee is paid to the shopkeeper.

CHAPTER V.—MORTGAGE.

1481. A *pawn* or *mortgage* is रेहन *rehan*, बन्धिक *bandhik*, or सकफूल *makphul*. It is also गिरौँ *giron* in Shahabad, and गिरनी *girmi* in South Bhagalpur. सकफूल *makphul* is more usually applied to mortgage of land, and the other terms to pawning of moveable articles; but this distinction is not universal. A *mortgagor* is राहिन *rahin*, and a *mortgagee* is मुरतहिन *murtahin*, but these words are seldom used. The villagers prefer to use words like खडुका *khaduka*, खडुक *khadduk*, or

बसानी *asāmi* for the former, and महाजन *mahājan* for the latter. In Patna a mortgagor is मुजैरा *mujera*, and in Shahabad a mortgagee is बेवन्दरिया *beohariya*.

1482. A *usufructuary mortgage*, in which both the principal and interest are extinguished by being paid out of the profits of the land mortgaged for a fixed period, is पटौचा *patuaa*, सटौचा पटौचा *sataua patuaa*, or सधौचा पटौचा *sadhua patuaa*. सूद भरना *sūd bharna* is similar, but the usufruct is only instead of interest, the principal remaining to be paid by the mortgagor. A बै बिल वफा (بيع بالوفا) *bai bil wafa* is a mortgage of property for a fixed period, in which, if the total debt is not repaid within the period, the property becomes the mortgagee's in satisfaction of the debt. Money advanced on the security of standing crops is to the north लागी *lāgi*.

CHAPTER VI.—MISCELLANEOUS.

1483. An *invoice* or *manifest* is बीजक *bijak*, and also to the east चिट्ठा *chittha* or फिरिस्त *phirist*. *Insurance* is बीमा *bīma*, with a variant बीँवा *bīnva* in Shahabad. In the south-west of the latter district it is ऊडा भारा *hunda bhāra*. Something additional given to a purchaser is north of the Ganges घलुआ *ghalua* or लाभ साम *lābh sābh*. In South-East Tirhut it is also लाभ *lābh*, and in South-West Tirhut बरन्कत *barkat*. South of the Ganges it is generally फाव *phāo* or पिछुआ *picbhua*. A variant of the latter is पछुआ *pachhua* in the south-east. Another name is चुटकी *chutki* in Patna. जूग *jūg* is similarly used by women when making petty purchases, especially of vermilion (सेनुर *senur*) and collyrium (मिस्सी *missi*). Other names for this are मँगनी *mangni* to the west and in South Tirhut, मँगनी चँगनी *mangni changni* in Patna, लावा घोली *lāwa gholi* north of the Ganges generally, लावा दूआ *lāwa dūa* in South-West Tirhut, and दाँटी *dānti*. बेआना *beāna* or बयाना *bayāna* is a *handsel* given by the buyer to the seller to secure his purchase.

1484. गल्ला *galla* is a hole in the ground or a bag under the shop-keeper's seat in which he keeps his money. To *test coin* is बूअब *būjab*, ठोकब *thokab*, परखब *parkhab*, जाँचब *jānchab*, बजाअब *bajāeb*, or अँकनब *anknab*. In the south-east it is परेखब *parekhab*. A *money-tester* is परखी *parkhi* or परखिया *parakhiya*, or जचुवैया *jachuvaiya*. In the south-east he is परेखिया *parekhiya*. In Patna he is परिख *parikh*,

and in Gaya रोकरीया *rokariya*. To test the correctness of scales is साध लेब *sādḥ leb*. In Patna and the south-east it is धारा करव *dhāra karav*, and in Shahabad पासँघ देखल *pāsangḥ dekhal*. To test a weight is ताड़व *tārav* or साधव *sādhab*.

1485. *Capital* is पूँजी *pūñji* or पुँजी *puñji*, and capital out-at interest is बियाजू *biyāju* or बेआजू *beāju*. It is also called सूदी रुपैया *sūdi rupaiya*. The *adjustment of accounts* is बुभारथ *bujhārath* north of the Ganges, and सफारि *saphāri* south of it. In South-West Shahabad it is बुभौता *bujhauta*. To test the entries is जाँच लेब *jānch leb* or मिला लेब *mila leb*. The testing is in Shahabad जाँच मिलान *jānch milān*. A *release in full* is फारखत्ती *phārkhatti* or फरखत्ती *pharkatti*. In the north-west they say in such a case सुभन्तान हो गेल *bhubhntān ho gel*, and in the east of Tirhut they say his account is राफ साफ *rāph sāph*, and in Patna that it is बेबाक भैल *bebāk bhail*. In Patna they say बही पर से नाम उतर गेल *bahī par se nām utar gel*, and in South-West Shahabad नाम घेरल गेल *nām gheral gel*, alluding to the custom of encircling the name with a line when the account is cleared off.

1486. To become *bankrupt* is दिवाला निकसब *divāla niksab*, or दिवाला सुध हो जाग्रब *divāla suḥ ho jāgrb*. To make a man a bankrupt is दिवाला निकासब *divāla nikāsab*. A bankrupt is दिवालिया *divāliya*. In Tirhut they would say of such a man साक उखड़ गेलैन्हि *sāk ukhar gelainhi*, or दिवाला उखड़ि गेलैन्हि *divāla ukhari gelainhi*. In all the above the word may also be spelt देवाला *devāla*. In Patna they say चोकर टाट उलटल है *okar tāt utal hai*, in allusion to the custom amongst bankers of a bankrupt turning up one corner of his mat and sitting on it, as a notice of his condition. The action is equivalent to putting up the shutters in England. In connection with this it may be mentioned that Patna is famous for its bankrupts, as in the lines commemorating the three rascals of Bihār :—

भागलपुर के भगेलिया, कहलगँव के ठग,
पटना के दिवालिया, तीनों नामजद,
सुने पावे छपराहिया, तीनों के तूरे रग.

*Bhāgalpūr ke Bhageliya, Kahalgānw ke thag,
Patna ke divāliya, tino nāmjad,
Sune pāve Chhaprahiya, tino ke tūre rag.*

—The Bhagels of Bhagalpur, the thags of Colgong, the bankrupts of Patna, are all famous (sharppers); but if a man of Chhapra hears this, he will beat them (*lit.* burst their veins) all (at their own weapons).

1487. A *bill of exchange* is झण्डी *hundi* or झण्डी पत्री *hundi patri*; also in Gaya and the south-west पतन्त्री *patri*. The duplicate of the bill is पैठ *painth*. Also, in Patna City, पेठ *peth*. The third duplicate is परपैठ *parpainth* or परपेठ *parpeth*, and the fourth जिक्करी *jikri* or जिगरी *jigri*. This last is also a letter to a person other than the drawer for the acceptance of his endorsement by the drawer. A *letter of advice* is समाचारी चिट्ठी *samāchāri chitthi*. A *bill payable at sight* is दरसनी *darسانی*. In Patna such bills by custom bear eleven days' date. If payable after a future date, it is मिथादी *miyādi* or मुदती *mudati*. One payable five days after sight is called पञ्च परमान *pahunch parmān* or (in Patna City) पञ्चे दाम *pahunche dām*. The *address* at the head of a banker's letter is जोग *jog* or सिरनामा *sirnāma*. A bill paid and discharged is खोखा *khokha*. In Patna it is also भुग्तान *bhugtān*, and north of the Ganges सुभन्तान *bhubhtān*. To *accept* a bill is सकारब *sakārab*. The date on which a bill falls due is called मिन्नी *mitti*, which indeed in mercantile transactions is the general word for dates of all kinds.

1488. A *warehouse* is गोदाम *godām*. चरन्जा *harja* is *demurrage*. महसूल *mahsūl* or मासूल *māsūl* is *customs, postage, or railway freight, &c.* A *price-current* is निरख नामा *nirakh nāma*. *Cash or specie* is नगद *nagad*, नगदा नगदी *nagda nagdi*, or रोक *rok*. पावना *pāwna* is a *claim*, and रसीद *rasid* a *receipt* टकसाल *taksāl* is a *mint*. *Merchandise* is सौदागरी के माल *saudāgri ke māl*. *Imports* are आमदनी *āmdani*, and *exports* रफ्तानी *raphtani*.

DIVISION XIV.

WEIGHTS AND MEASURES.

CHAPTER I.—MEASURES OF LENGTH.

1489. The अङ्गुल *angul* is a finger-breadth, equal to about two-thirds of an inch. The width of the four fingers of one hand, *i.e.*, four अङ्गुल *angul*, is called a चौथा *chaua*. Instead of this, a measure is used in Shahabad called मुट्ठा *muttha*, which is the width of the closed fist. Twelve finger-breadths make one span, which is बिन्ना *bitta* or बिलस्ता *bilasta*, or to the north-east बिलहस्त *bilhast*, to the south-east बिलस्त *bilast*. South of the Ganges a still smaller scale is current. A सूत *sūt* is the thickness of thread.

3 सूत *sūt* = 1 पेन *pain*.

3 पेन *pain* = 1 finger-breadth.

1490. In Shahabad and the south-east a finger-breadth is तस्सुर *tassur*. In Shahabad and Patna in measuring wood, however, a तस्सुर *tassur* equals two finger-breadths, and fourteen of these make one गज *gaj* or हाथ *hāth* (wood measure). Twenty-four finger-breadths, or six चौथा *chaua*, or two बिन्ना *bitta*, make one हाँथ *hānth* or हाथ *hāth*, which is a cubit. The हाथ *hāth* is the standard from which the others are taken, and varies from 15 to 20 inches in length, 18 inches being the average.

1491. Two cubits make one डेग *deg* or pace, and also one गज *gaj* or yard. A गिरह *girah*, गिरेह *gireh*, or गिरे *gire* is the length of the forefinger, and 16 go to a गज *gaj*. Another name for a गिरह *girah* is कनवाँ *kancān* in Patna and Gaya. Three गज *gai* or six cubits make one लग्गा *lagga* or लग्गी *laggi*, which is also called बाँस *bāns*

south of the Ganges, and लट्ठा *lattha* in South-West Shahabad. Another गज *gaj* is the सिक्कन्दरी गज *Sikandri gaj*, also called बरा गज *bara gaj* or बड़का गज *baraka gaj*, which is $2\frac{1}{4}$ cubits north of the Ganges and 48 fingers or 2 cubits south of it. It was the yard used in land measuring until Akbar's time, and properly equals 26 inches, but has become in the village mind confused with the बरा गज *bara gaj*. This is the tailor's yard, and is called by them कतारै गज *katai gaj* or कत्ती गज *katti gaj*. Akbar introduced as the standard measure of the empire the इलाही गज *ilahi gaj*, equal to $33\frac{1}{2}$ inches, which is still in use in the North-West Provinces.

1492. In South-East Tirhut and Patna धाप *dhāp* equals डेग *deg* or कदम *kadam*, a pace, but elsewhere north of the Ganges and in the south-east it is about half a कोस *kos*; see below. Another name of this last is मैल *mail* or मील *mīl*, a corruption of the English 'mile.' The रस्सी *rassi* or रसरै *rasri* is equal to 20 लग्गी *laggi* or 120 cubits. In South-West Shahabad 70 cubits make a रस्सी *rassi*. Generally 60 रस्सी *rassi* make one कोस *kos*, but in South-West Shahabad it is 50 रस्सी *rassi*. The कोस *kos* varies greatly in length in different districts. An ordinary कोस *kos* is however 60 रस्सी *rassi*, 1,200 लग्गी *laggi*, or 3,600 गज *gaj* or yards, or 80 yards more than two miles. The गौकोस *gaukos* is a vague measure of distance, as far as a cow's bellow can be heard. A कच्चा कोस *kachcha kos* is a short कोस *kos*, and धाप *dhāp* (see above) is generally about a mile.

1493. A cubit used in measuring earthwork and well-sinking is नरन्दा *tarha* to the north-west and खनित *khanit* (literally, digging) in the south-west. In South-West Shahabad and South-East Tirhut it is खन्ना *khanta*. In Gaya it is नरन्दा *tarra*, and to the south-east गिलन्दाजी *gilandāji* (which means simply earth-work). In digging a well the depth is measured in men's heights, called पूरिस *pūris*, &c. See § 923.

1494. The following table shows the relative value of the principal measures of length.

CHAPTER II.—SUPERFICIAL MEASURE.

1495. The पक्का बिगन्हा *pakka bigha* is fixed at 14,400 square feet, or 1,600 square yards. It is therefore a little less than $\frac{1}{3}$ of the English acre of 4,840 square yards. The कच्चा बिगन्हा *kacheha bigha* varies in every *pargana*; it is generally smaller than, but is sometimes larger than, the standard. The foundation of the size of the *bigha* is the लग्गी *laggi* (see above, § 1491), which varies greatly in the number of cubits which it contains. A square लग्गी *laggi* is a घूर *dhūr*. Twenty घूर *dhūr* make one कट्ठा *kattha*, and 20 कट्ठा *kattha* make one बिगन्हा *bigha*. In Shahabad a कट्ठा *kattha* is called a बिसन्वा *biswa*. In East Tirhut a बिगन्हा *bigha* is also called कूरो *kūro*. North of the Ganges 4 पाद *pāi* make one घूर *dhūr*; south of it—

9 square चौथा *chautha* make 1 sq. डेग *deg* or कदम *cadam*.

9 ,, डेग 1 sq. घूर *dhūr*.

CHAPTER III.—MEASURES OF PROPORTION.

1496. Proportion is generally expressed by saying so many annas in the rupee. Thus 10 annas in the rupee = 10 : 16; 4 annas in the rupee = 1 : 4; 8 annas in the rupee = 1 : 2; and so on. In calculating proportionate shares in estates, two systems are in vogue. In both the estate (मौजा *manja* or महाल *mahāl*) is the unit. In one system the following is the scale :—

1 मौजा *manja* or महाल *mahāl* = 16 आना *āna*.

1 आना *āna* = 20 दाम *dām*.

1 दाम *dām* = 20 कौड़ी *kauri*.

1 कौड़ी *kauri* = 20 बौड़ी *bauri*.

1 बौड़ी *bauri* = 20 फौड़ी *phauri*.

1 फौड़ी *phauri* = 20 रौड़ी *rauri*.

The other system is as follows :—

1 मौजा *manja* or महाल *mahāl* = 16 आना *āna*.

1 आना *āna* = 12 पाद *pāi*.

1 पाद *pāi* = 20 करंत *karānt*.

1 करंत *karānt* = 20 मसंत *masānt*.

1 मसंत *masānt* = 20 डिस्मिल *dismil* (? = decimal).

1 डिस्मिल *dismil* = 20 बिस्मिल *bismil*.

1498. In weighing, the रत्ती *ratti* of 1·875 grains Troy is taken as the standard. From this the following scheme may be drawn up :—

8 रत्ती <i>ratti</i>	= 1 मासा <i>māsa</i> = 15 grains Troy.
12 मासा <i>māsa</i>	= 1 तोला <i>tola</i> = 7 dwt. 12 grains Troy ^o or the weight of one rupee.
5 तोला <i>tola</i>	= 1 कनवाँ <i>kanvān</i> or चटाँक <i>chhatānk</i> = 1oz. 17 dwt. 12 grains Troy.
16 कनवाँ <i>kanvān</i> or चटाँक <i>chhatānk</i>	= 1 सेर <i>ser</i> = 2lb. 6 oz Troy.
40 सेर <i>ser</i>	= 1 मन <i>man</i> = 100lb. Troy = 82·286lb. Avoirdupois. This is the standard मन <i>man</i> or maund, and 27·222 of these go to the English ton.

For larger weights the सेर *ser* is the standard. In local bazārs it varies greatly, not only according to locality, but according to goods sold. The bazār सेर *ser* is named as containing so many गण्डा *ganda*, a गण्डा *ganda* consisting of four तोला *tola* or sometimes four pice, and being a constant quantity.

1499. In weighing gold, jewels, &c., the standard is the red seed (*abrus precatorius*) called the करञ्जनी *karjani*, लाल *lāl*, or कच्ची रत्ती *kuchchi ratti*. It is said to weigh three barleycorns (जौ *jau*).

The jeweller's scale is as follows :—

3 जौ <i>jau</i>	= 1 लाल <i>lāl</i> .
4 ditto	= 1 रत्ती <i>ratti</i> .
2 लाल <i>lāl</i>	= 1½ रत्ती <i>ratti</i> .
4 रत्ती <i>ratti</i>	= 1 चौरत्ती <i>chauratti</i> .
5½ ditto	= 1 अन्नी <i>anni</i> .
8 ditto	= 1 मासा <i>māsa</i> , मससा <i>massa</i> , or मसिका <i>masika</i> = 15 grs. Troy.
10½ ditto	= 1 दुषन्नी <i>duanni</i> .
8 दुषन्नी <i>duanni</i> or 10½ मासा <i>māsa</i>	= 1 ढक <i>dhak</i> or (in South-West Shahabad) ढाका <i>dhāka</i> , which is the weight of a rupee = 6 dwts. 6½ grs. Troy.
12 मासा <i>māsa</i>	= 1 तोला <i>tola</i> = 7 dwts. 12 grs. Troy. Here it will be seen that the jeweller's rupee is less than a tola.

1500. The following weights are common throughout Bihār :—

छटक्की *chhatanki* = $\frac{1}{16}$ of a *ser*.

अधन्पै *adhpai*, अधन्पाज *adhpaü*, or अधन्पौषा *adhpausa* = $\frac{1}{8}$ of a *ser*
पाव *pāv*, पावा *pāva*, or पौषा *paua* = $\frac{1}{4}$ of a *ser*.

अधन्सेरा *adhsera* or असेरा *asera* = $\frac{1}{2}$ a *ser*.

तिनन्पौषा *tinpausa* = $\frac{3}{4}$ of a *ser*.

सवैया *sawaiya*, properly $1\frac{1}{4}$ *ser* ; really $\frac{1}{2}$ of a पसेरी *pase-ri*.

डेहन्सेर *derhseri* = $1\frac{1}{2}$ *ser*.

अहा *arha*, अहैया *arhaiya*, properly $2\frac{1}{2}$ *ser* ; really $\frac{1}{2}$ of a पसेरी *pase-ri*.

तिनन्सेरा *tinsera* or तिनन्सेरी *tinseri* = 3 *ser*.

चरन्सेरा *charsera* or चरन्सेरी *charseri* = 4 *ser*.

पसेरी *pase-ri*, also (in Shahabad) पन्सेरा *pansera*, or पन्सेरी *panseri*.

This is properly 5 *ser*, but varies greatly. It is usually said to be 7 *ser kachcha*, but is sometimes only 5 or 6. Vegetable-sellers generally call it 6 *ser*.

धारा *dhāra* = 10 *ser*. In Shahabad it sometimes means 5 *ser*.

APPENDIX.

FORMS OF ACCOUNTS USED IN A LANDLORD'S OFFICE IN PATNA.

1.

खसरा दानाबन्दी *Khasra Dānābandi.*

YEAR.—

Khasra Dānābandi of the

Crop in the Estate of

DATE.—

Name of tenant.	Length.	Breadth.	Area of plot.	Kind of crop.	Amount of crop estimated.

1a.

तिरिज तारीखवार *Tirij Tārikhwār.*

YEAR.—

Tirij Tārikhwār of the Khasra Dānābandi of Village

Date.	Total area of crop estimated.	Total amount of crop estimated.

2.

खसरा बटार *Khasra Batāi*.

YEAR.—

*Khasra of Division of**Crop in the Estate of*

DATE.—

Name of tenant.	Area.	Kind of crop.	Amount of grain.	Landlord's share.	<i>Dahiyak</i> .*	<i>Pansera</i> .†	Total of columns 5 to 7.

2a.

Abstract of the above.

(1) Date	} In the original, the columns run across the page instead of from top to bottom.
(2) Area	
(3) Total amount of grain	
(4) Landlord's share	
(5) दाहियक <i>dahiyak</i> *	
(6) पन्सेरा <i>pansera</i> †	
(7) Total	
(8) सोनारी <i>sonari</i> (weighman's fees)	
(9) गन्ज अफजूद <i>ganj aphjud</i> ‡	
(10) बर्ही <i>barhi</i> §	
(11) सड्डी <i>saddhi</i>	
(12) Total	

* *Vide* foot note to form (5).† After the division of crop, *dahiyak* is added to the landlord's share, to which again 5 seers are added, that quantity being taken from the tenant's share under the name of *pansera*.

‡ Grain found in excess at the time of second weighing on the floor after the grain has been taken over by the landlord.

§ Grain found in excess at the time of third weighing, when the grain has been carried to the landlord's granary.

|| Grain found in excess owing to swelling, &c., when the whole amount of grain stored has been sold off.

3.

मोफरीद *Mophrid*.

YEAR.—

*Mophrid of the Rent in Kind for the**Crop.*

NAME OF TENANT.—

Black Paddy.

Date of Estimate.	Area.	Amount of Crop.

Paddy Sown Broadest.

Date of Estimate.	Area.	Amount of Crop.

Bismatti Paddy.

Date of Estimate.	Area.	Amount of Crop.

and so on for every kind of grain in the tenant's holding.

Total Area.	Total Amount of Grain.

3a.

Abstract of the last.

YEAR.—

Name of Tenant.	Total Area.	Amount of Crop.

4.

लगित *Laggit* and वासिल बाकी *Wāsīl Bāki*.

YEAR.—

Laggit of Rents Paid in Kind for the Whole Year.

NAME OF TENANT.—

Kind of grain.	Area.	Total grain.	Share of landlord.	<i>Dahiyak</i> .*	Total due.	Realized.	Balance.

* See note to form 5.

4a.

Abstract of the last.

YEAR.—

Black Paddy.

Name of Tenant.	Area.	Amount due.

White Paddy.

Name of Tenant.	Area.	Amount due.

and so on for each kind of grain.

5.

तिरिज जिनिसवार *Tirij Jiniswār.*

YEAR.—

Tirij Jiniswār for the Village of

1. Name of tenant.
2. Area under cultivation.
3. Grain due.
4. *Dahiyak*.*
5. Total.
6. Amount of maize.
7. Ditto of *marua*.
8. Ditto of *sāthi* paddy.

And so on, a separate column being allotted to each crop.

In the original, the form runs across the page in columns, and not from top to bottom.

* This is the amount the landlord receives in addition to his half share. South of the Ganges he generally realizes 5 *ser* per *man*, i.e. he receives 9 *ser* in every 16 *ser*, the tenant's share being 7 *ser*. This division of crop is called "नौसत्ता *nau-satta*," i.e. 9-7 See § 596.

6.

मियाहा *Siyāha.*

YEAR.—

Day-book of Receipts and Disbursements of Grain.

DATE.—

<i>Receipts.</i>		<i>Disbursements.</i>	
	Amount.		Amount.
From so and so—			
<i>Sāthi</i> paddy 5 maunds	} 7 maunds	Sent to the landlord
Broadcast		Sold, viz.
paddy ... 2 „			
From so and so	Total Mds.
Total Mds.	Balance Mds.

6a.

Abstract of above, or अवारजा Awārja.

RECEIPTS.		EXPENDITURE.	
Date.	Amount of Grain.	Date.	Amount of Grain.

7.

हिसाब बिकरी गधा *Hisāb Bikri Galla.*

YEAR.—

Date.	Amount sold.	Rate.	Price realized.

8.

खसरा *Khasra.*

YEAR.—

*Khasra showing the Measurements of Lands let at Cash Rates in
the Village of*

DATE.—

Name of Tenant.	Length.	Breadth.	Area.	Class of Land or rate per bigha.

8a.

Abstract of the above.

YEAR.—

*Tirij Khasra showing the Measurements of Lands let at Cash Rates
in the Village of*

Date.	Area.

9.

मोफरौद *Mophrud.**Mophrud of the Lands paying Cash Rates in the Village of*

YEAR.—

NAME OF TENANT.—

At Rs. 4 per bigha.

Date of Measurement.	Area.

At Rs. 3 per bigha.

Date of Measurement.	Area.

and so on for the various rates at which the tenant holds.

9a.

Abstract of the above.

YEAR.—

Tirij Mophrūd of the Lands paying Cash Rates in the Village of

Name of Tenant.	Area held by him.	Rent.

10.

लग्गित Laggit and वासिल-बाकी Wāsil-baki.

YEAR.—

Laggit of Rents payable in Cash in the Village of

NAME OF TENANT.—

Class of land held by him.	Area.	Rate of the class.	Rent.

Total rent
Cesses...
Value of unrealized rent in kind for the year			
Arrears of previous years
Total demand
Deduct realizations
Balance to be carried to next year's account			

10a.

Abstract of the above.

YEAR.—

तिरिज लगीत *Tirij Laggit of Lands paying Cash Rates in the Village of**At Rs. 4 per bigha.*

Name of Tenant.	Area.	Rent.

At Rs. 3 per bigha.

Name of Tenant.	Area.	Rent.

and so on for each rate of rent.

11.

तिरिज पडेवारी *Tirij Patewāri for the Village of*

Class of Land or Degrees of Rate.	Area.	Rate.	Rent.
1st class
2nd do.
And so on

12.

बिघावा *Siyāha.*

YEAR.—

Day-book of Receipts and Disbursements of Cash.

DATE.—

RECEIPTS.		EXPENDITURE.	
Name of Tenant.	Amount paid.	Description of expenditure.	Amount.

BALANCE.

12a.

*Abstract of the above, or अवारजा *Awārja*, showing Expenditure only.*

Amount sent to Landlord.

Date.	Amount.

Salary of Village Establishment paid.

Date.	Amount.

गिलनग्दाजी Gilandāji Expenses (Repairs to Embankments, &c.)

Date.	Amount.

गरामन्ता Garāmta (Diet-money supplied to the गोरैत Gorait, who takes Money to the Landlord).

Date.	Amount.

and so on.

13.

मोलहकी *Molhaki.*

YEAR.—

Molhaki of Payments in Cash and Kind for the Whole Year.

NAME OF TENANT.—

CASH PAYMENTS.		PAYMENTS IN KIND.	
Date.	Amount.	Date.	Amount of Grain.

13a.

Abstract of the above.

YEAR.—

Name of Tenant.	Total amount paid by him in cash.	Total amount paid by him in kind.

14.

धडा Dhadha.

(In the original, the columns run across the page, instead of from top to bottom. The various cesses, &c., named are only samples, and differ in every village.)

Y_{FAR}.—

Dhadha Wāsībāki for the Whole Year in the Village of

Columns.

- (1) Name of tenant.
- (2) Area of holding in subheads according to rate and class.
- (3) Rent.
- (4) दुधनी *duanni*.*
- (5) Weighman's fees (सोनारी *sonāri*).
- (6) काह चराह *kāh charāi*.†
- (7) कोठी सोरा *kothī sorā*.‡
- (8) मोतरफा *motarpha*.§
- (9) विकारी चास *bikri am* (price of mangos).
- (10) तार *tār* (rent of toddy-palms).
- (11) Rent for *mahua* trees.
- (12) मछली *machhli* (fishery-dues).
- (13) Total of above.
- (14) बट्टा माल *batta māl*.||
- (15) बट्टा कम्पनी *batta kampani*.||
- (16) Road-cess.
- (17) Unrealized grain-rent.
- (18) Arrears.
- (19) Grand total of demand.
- (20) Deduct share of other landlords.
- (21) Remainder, *i.e.*, हिस्सा खास *hissā khās* (own share).
- (22) Realized.
- (23) Balance due.
- (24) Credit, realized in excess.

* See § 1201.

† Dues for grazing cattle. All cattle, except buffalos, are generally exempt. Each buffalo is charged at from 2 to 4 annas a year. See § 1151.

‡ Rent of a saltpetre factory.

§ Rent of houses occupied by shopkeepers, oil-men, weavers, and other non-cultivating tenants. See § 1201.

|| See § 1202. These are only charged on rent of land and on old settlements of other kinds. For instance, if a new settlement is made of toddy palms, it is made in Company's rupees, and no exchange rate is added to the rent. The addition of a rate of exchange, in fact, depends on whether the settlement is made in old coinage or in new; and according to custom, rent of land is generally settled, even at the present day, in the old coinage, but not so other rents.

जमिंदारी Jamābandi.

Jamābandi of Village for the Whole Year F. S.

Note.—The order of the items has been reversed for the sake of clearness. In the original, according to native custom, the totals are written first, and under them the subsidiary items. For a similar reason imaginary figures have been written against the various items.

	Area.		Demand.	
	B.	K. DH.	Rs.	A. P.
Land of 1st class, at Rs. 4
Ditto 2nd ditto 3	800	0 0
Ditto 3rd ditto 2-8	2,400	0 0
Ditto 4th ditto 2	1,250	0 0
And so on.	1,000	0 0
Total area under cultivation	2,000	0 0		
Add area not under cultivation	100	0 0		
Total area of village	2,100	0 0		
Total rent-demand		5,450	0 0
Add cesses (only legal ones entered here)		300	0 0
आगत सार (i.e., miscellaneous rights, e.g., fishing-rights. Cf. § 1232)		250	0 0
Total demand under jamābandi		6,000	0 0

16.

बजाजिराज जामाबखारच.

Jamākharch of Village for the Whole Year F. S.

Note.—The order of items has been reversed as in No. 15, from which also the imaginary figures are carried into this form.

DEMANDS.		OUTGOINGS.	
Nature of Demands.	Rs. A. P.	Nature of Outgoings.	Rs. A. P.
Balance of arrears of previous year's <i>jama-kharach</i> —		Realized in cash and remitted to landlord	4,000 0 0
(a) Principal	300 0 0	Ditto in kind ditto	500 0 0
(b) Interest thereon, and fines, &c., on defaulters in respect to it	50 0 0	Total remitted to landlord	4,500 0 0
Total Balance	350 0 0	Village expenses—
Demand for present year—		Salary of establishment	500 0 0
(a) As per <i>jama-bandī</i>	6,000 0 0	बजाजिराज <i>gilandā</i> * expenses	247 0 0
(b) Not in <i>jama-bandī</i> (Here are entered in detail all illegal cesses, &c., which have been excluded from the <i>jama-bandī</i>)	400 0 0	And so on.
Total, say	6,400 0 0	Total village expenses	747 0 0
Total for present year	6,400 0 0	Miscellaneous expenses—
GRAND TOTAL OF DEMAND	6,750 0 0	बजाजिराज <i>panigochā</i> †	150 0 0
		बजाजिराज <i>garāmī</i> *†	3 0 0
		And so on in detail.
		Total miscellaneous expenses	153 0 0
		Balance—
		With the <i>gumāshtā</i> (in hand)	50 0 0
		Due from the tenants (each tenant's name in detail)	1,100 0 0
		With the grain-mERCHANTS†	200 0 0
		Total balance	1,350 0 0
		GRAND TOTAL	6,750 0 0

* See No 12a | † Price of water supplied by a neighbouring landlord for irrigation. | This last balance is technically called बजाजिराज *Leqi*.

INDEX.

(The numbers refer to paragraphs.)

॥ अ a ॥

- अकन्टा *akta*, 1075, 1183
 अकन्डा *ankra*, 794.
 अकन्डी *ankri*, 794, 1183, 1266.
 अकन्डेल *ankrail*, 794.
 अकन्डौर *ankraur*, 794.
 अकद् *akad*, 1273.
 अकद् सानी *akad sāni*, 1279.
 अकन्ब *anknab*, 1484.
 अकन्रा *ankra*, 1075.
 अकन्राह *akrāh*, 786.
 अकन्रिया *ankariya*, 1118.
 अकन्री *akri*, 24, 1272.
 अकन्री *ankri*, 1075, 1183.
 अकन्वारिया *ankwariya*, 236.
 अकन्वार *akwār*, 886.
 अकन्वार *ankwār*, 886.
 अकाल *akāl*, 965a.
 अकाल गिर *akāl gir*, 965a.
 अकाल बिर *akāl bir*, 965a.
 अकाली *akāsi*, 68, 363.
 अकुरा *akura*, 500.
 अकुरा *ankurha*, 376, 412, 414, 957.
 अकुरा *akura*, 564.
 अकुरा *ankura*, 222, 376, 414, 412,
 500, 564, 936, 1001.
 अकुरा *ankurāi*, 1009.
 अकुरी *akuri*, 102, 566, 1424.
 अकुरी *ankuri*, 222, 412, 564, 877.
 अकुसा *ankusa*, 500.
 अकुसी *ankusi*, 41, 376, 500.
 अकोरा *ankora*, 32, 172, 376, 412.
 अकोल के तेल *akol ke tel*, 1045.
 अखहन्वा *akharhwa*, 1086.
 अखमुद्गनी *ankhmundni*, 97.
 अखरन्तिजिया *akhartijiya*, 1414.
 अखरन्तीज *akhartij*, 1414.
 अखरन्तीज *akhartit*, 1414.
 अखरहा *akhraha*, 1234.
 अखरा *akhra*, 1272.
 अखरी *akhri*, 1272.
 अखरो *akhro*, 1272.
 अख्वा *ankhwa*, 1009.
 अखाह *akhārḥ*, 1039, 1082, 1083.
 अखाही *akhārhi*, 1009, 1039.
 अखाही कोरान *akhārhi koran*, 1009.
 अखिया *ankhiya*, 1009, 1010, 1376.
 अखियाय *ankhiyāy*, 1009.
 अखुषा *ankhua*, 769, 987, 1001, 1009,
 1010.
 अखुषा *ankhuāḥ*, 987.
 अखुषा *ankhuāḥ*, 1009.
 अखुषा *akhetā* 933

अखेद *akhed*, 933.
 अखेना *akhena*, 76.
 अखैन *akhain*, अखैना *akhaina*, 76.
 अखैला *akhaila*, 431.
 अखेतो *akhoto*, 933.
 अखौत *akhaut*, 611, 933, 940.
 अखौता *akhauta*, 431, 464, 611, 933,
 940.
 अखौता *ankhauta*, 933.
 अँगैँ *angāññ*, 1203.
 अगकङ्गना *agkarhna*, 319k.
 अगङ्गा *agra*, 875.
 अगङ्गौर *agraur*, 1186.
 अगन्ती *agti*, 1332.
 अगन्दाँ *agdāin*, 889.
 अगन्दाँ *agdāen*, 889.
 अगन्दाँयाँ *agdāmyān*, 889.
 अँगन *angna*, 1237, 1254.
 अँगनै *angnai*, 1237.
 अगन्वर *agbar*, 901, 1203.
 अँगरखा *angarkha*, 728, 729.
 अगरपाठ *agarpāt*, 918.
 अगरबन्धु *agarbandhu*, 1010.
 अँगरन्वार *angarwār*, 281.
 अँगरन्वाह *angarwāh*, 293.
 अगन्स *agras*, 366.
 अगन्रा *agra*, 1008, 1010, 1012.
 अँगन्रा *angra*, 1074.
 अगन्राय *agrāy*, 1089.
 अगन्री *agri*, 1250, 1252.
 अँगन्जी *angrji*, 504, 1263.
 अगन्रैल *agrail*, 679.
 अगन्रौटा *agrauta*, 1272.
 अगन्ला *ayla*, 875.
 अगन्वड *agwar*, 842, 844, 1186.
 अगन्वड जन *agwar jan*, 842.
 अगन्वड *agwarh*, 842.
 अगन्वड जन *agwarh jan*, 842.
 अगन्वन *agwan*, 1186, 1475.
 अगन्वरिया *agwariya*, 842.

अँगन्वरिया *angwariya*, 842, 846.
 अगन्वार *agwār*, 901.
 अँगन्वार *angwār*, 842.
 अँगन्वारा *angwāra*, 846.
 अगन्वारी *agwāri*, 901.
 अगन्वास *agwās*, 1237.
 अगल *agast*, 1091.
 अगन्हन *aghan*, 1082, 1092.
 अगन्हनुआ *aghanua*, 996.
 अगाऊर *agāūr*, 1186.
 अगाड *agār*, 113, 901, 914, 1012.
 अगाडी *agāri*, 113.
 अगार *agār*, 113, 931, 1186.
 अगारी *agāri*, 113, 931, 1008.
 अँगारी *angāri*, 288, 585.
 अगाह *agāh*, 655.
 अगिनन्वाय *aginbāy*, 1170.
 अगिया *agiya*, 1075, 1170.
 अगिया बैताल *agiya baitāl*, 1458.
 अगिया *angiya*, 607, 744.
 अगियासी *agiyāsi*, 1332, 1398.
 अगिला *agila*, 235 (footnote).
 अगुआ *agua*, 558, 1286.
 अगुआनी *aguāni*, 1237.
 अगुआर *aguār*, 1237.
 अगुआरा *aguāra*, 1237.
 अँगुठा *angutha*, 760, 772.
 अँगुठी *anguthi*, 756, 769.
 अगुत्ती *agutti*, 1237.
 अँगुस्ताना *angustāna*, 769.
 अगूत के ठाठ *agūt ke thāt*, 1245.
 अँगुडीहा *angeriha*, 292.
 अँगैठा *angetha*, 529, 567.
 अँगैठी *angethi*, 567, 1409.
 अँगैड *agenr*, 1010, 1012, 1144.
 अँगैर *anger*, 1008, 1012.
 अँगैरबन्धु *angerbandhu*, 1010.
 अँगैरा *angenra*, 1008.
 अँगैरी *angeri*, 1010, 1012.
 अगेला *agela*, 363, 558.

- अंगैठा *angait̥ha*, 529, 1247.
 अंगैठी *angait̥hi*, 1247.
 अगोरिया *agoriya*, 870.
 अंगोछा *angochha*, 733.
 अगोरनिहार *agornihār*, 870.
 अगोर बटाइ *agorbatāi*, 914, 1470.
 अगोरा *agora*, 870.
 अगोरी *agori*, 870.
 अगौँ *agauñ*, 1203.
 अंगौँआ *angauñāñ*, 1203.
 अंगौँआ *angauchha*, 733.
 अंगौँही *angauchhi*, 733.
 अगौड़ी *agauri*, 1186.
 अगौरी *agauri*, 844, 1186.
 अङ्कुस *ankus*, 102.
 अङ्ग *ang*, 655.
 अङ्गा *anga*, 729, 731, 972.
 अङ्गुल *angul*, 1489.
 अचकन *uchkan*, 729.
 अचन्ताहर *anchtāhar*, 303.
 अचन्ना *anchna*, 303.
 अचन्मनी *uchmani*, 774.
 अचन्रा *uchra*, 741.
 अचन्रा *anchra*, 741.
 अचन्री *anchri*, 766, 1331.
 अचन्री पालो *añchri pālo*, 1331.
 अचार्ज *achārj*, 1347.
 अचन्वाहा *anchwāha*, 303.
 अडा *alda*, 547.
 अचौना *anchauna*, 774.
 अचौनी *anchauni*, 774.
 अच्छत *achchhat*, 1319, 1329.
 अच्छा सगुन *achchha sagun*, 1454.
 अहन्वानी *achhwāni*, 1399, 1409.
 अहि *achhi*, 957.
 अहिया *achhiya*, 1248.
 अहै तिरन्तिया *achhai tirtiya*, 1444.
 अजब सालार *ajab sālār*, 1456.
 अजमोदा *ajmoda*, 1073.
 अजन्वारन *ajwāñ*, 639, 1073.
 अजान *ajāñ*, 969a.
 अँजुरी *anjuri*, 912, 1194, 1401.
 अजिचौरा *ajiaura*, 1301.
 अजू *aju*, 984.
 अजूरा *ajūra*, 1185.
 अची *anchi*, 1034.
 अँडुर *anjur*, 1194.
 अटन्का *atka*, 1183.
 अटार *atār*, 234.
 अँटिया *antiya*, 862, 882, 884, 894, 982, 1194.
 अठनिया *athaniya*, 1214.
 अठनी *athanni*, 1214.
 अठन्मंगर्रा *athmangra*, 1305.
 अठन्मसुचा *athmasua*, 1396.
 अठन्मास *athmās*, 1396.
 अठन्वन्नी *athwāñni*, 1479.
 अठन्वारा *athwāra*, 1205.
 अठन्वाँस *athwāñs*, 1396.
 अठन्वाँसू *athwāñsu*, 1396.
 अँदली *andhali*, 1183.
 अटोतन्नी *athotri*, 781.
 अठौंगर *athougar*, 1323.
 अठौंगर *athaungar*, 1323.
 अड्ग्वड *arkhw*, 1250.
 अँडड *andar*, 1045.
 अँडन्नी *andri*, 1045.
 अडा *ara*, 987, 1153.
 अडा गेल *aru gel*, 987.
 अडान *arāñ*, 1153.
 अडानी *arāni*, 29, 216, 613, 952.
 अडार *arār*, 1147, 1153.
 अडाँस *arāñs*, अँडास *arwās*, 937.
 अडियातक *ariyatāk*, 1056.
 अडा *arha*, 1500.
 अडाइ *arhāi*, 473.
 अडाइ खन्दा *arhāi khanda*, 473.
 अडिया *arhiya*, 714.
 अडेया *arheya*, 1180.
 अडेया *arhaiya*, 713, 1180, 1500

- अण्डा *anṭā*, 48.
 अण्डी *anti*, 498.
 अण्डा *anṭa*, 1045.
 अण्डी *andi*, 1045.
 अतर *atar*, 1381.
 अंतन्त्रा *antra*, 1050.
 अतन्त्रावन *atrāvan*, 363.
 अतन्त्रावन भोज *atrāvan bhāj*, 363.
 अतार *atār*, 1058.
 अतीथ *atith*, 1429.
 अथन्ना *athra*, 430, 465, 506, 584.
 713.
 अथन्नी *athri*, 251, 253, 319a, 576.
 713.
 अथन्वानी *athvāni*, 579.
 अथन्सञ्चन *athsanchan*, 1424.
 अदन्त *adant*, 1118.
 अदन्मी *admi*, 1217, 1274.
 अदन्क *adrak*, 1073.
 अदन्ख *adrakh*, 1073.
 अदन्ना *adra*, 866, 1009, 1082,
 1085, 1089.
 अदन्ना के कोड़नी *adra ke korni*,
 1009.
 अदन्ना कोरन *adra koran*, 866.
 अदन्लई *allai*, 1461.
 अदन्लई बदन्लई *allai badlai*, 1461.
 अदन्वरी *advari*, 1272.
 अदार *adār*, 1098.
 अदारी *adāri*, 1098.
 अदिमी *adimi*, 1274.
 अदौरी *adauri*, 1272.
 अधधन्नी *adhanni*, 1479.
 अधन्कड़ *adhkar*, 1214.
 अधन्कड़ किल *adhkar kist*, 1214.
 अधन्कर *adhkar*, 372, 713, 1214.
 अधन्कार *adhkār*, 372.
 अधन्खर *adhkhar*, 1214.
 अधन्पई *adhpaī*, 1500.
 अधपक्क *adhpakku*, 957.
 अधन्पाज *adhpaū*, 1500.
 अधन्पौषा *adhpaūa*, 1500.
 अधन्बटिया *adhbatiya*, 904.
 अधन्बटैया *adhbatāiya*, 904.
 अधन्भरी *adhbhari*, 898.
 अधन्रस्सी *adhrassi*, 1399.
 अधन्री *andhri*, 1007.
 अधन्री पटावन *andhri patāvan*, 1007.
 अधन्लप्पा *adhlappa*, 1190.
 अधन्ला *adhla*, 422.
 अधन्लावा *adhlaūa*, 1190.
 अधन्वा *adhwa*, 1054.
 अधन्सेरा *adhsera*, 1500.
 अधन्धारी *andhāri*, 226, 1249.
 अधिकार *adhikār*, 1354.
 अधिकार माला *adhikār māla*, 1354.
 अधिया *adhiya*, 904, 1214
 अधियारी *andhiyāri*, 97.
 अधेल्चा *adhelecha*, 1497.
 अधेरी *andheri*, 866
 अधेरी कोरन *andheri koran*, 866.
 अधेला *adhela*, 1497.
 अधेली *andheli*, 97.
 अधैल *adhail*, 1118.
 अन् *an*, 990.
 अन्जान *anjān*, 1183.
 अन्त *anat*, 1443.
 अन्न *anan*, 754, 767, 1443.
 अन्नन्द *anand*, 1085.
 अन्पट *anpat*, 97.
 अन्पन्नासन *anprasan*, 1407.
 अन्वाह *anvāh*, 845, 1097.
 अनाज *anāj*, 1272.
 अनाठा *anātha*, 1157.
 अनान्त *anāthū*, 379.
 अनार *andr*, 585, 977.
 अनार कली *anār kali*, 977.
 अनुषा *anua*, 951.
 अनुराधा *anurādha*, 1082.
 अनेरवा *anerwa*, 1132.

अनरिना *aneriya*, 1147.
 अनेर *aner*, 1132.
 अनैरा *anera*, 1147.
 अनौआ *anaua*, 951.
 अन्तर कटन्वा *antar kutwa*, 1175.
 अन्ती *anti*, 753.
 अन्दरात *andurāt*, 1254.
 अन्न *ann*, 1272.
 अन्नी *anni*, 1499.
 अन्स *ans*, 1203.
 अन्हरिया *anhariya*, 1009.
 अन्हाव *anhao*, 915.
 अपटन *aptan*, 1342.
 अपटा *apta*, 801, 918.
 अपत्नी *apti*, 233.
 अपत्ने *apne*, 1275.
 अपपन *appan*, 1113, 1446.
 अफजूद *aphjūd*, Appendix, 2a.
 अफतावा *aph tāva*, 698, 711.
 अफताया *aph tāya*, 698.
 अब *ab*, 1088, 1091.
 अबन्खोरा *abkhora*, 690, 713.
 अबन्टन *abtan*, 661, 1342.
 अबदा *abda*, 1076.
 अबरा *abra*, 739.
 अबन्वाव *abwāv*, 1470.
 अबदा *abād*, 795, 799.
 अबदादी *abādi*, 784, 795, 799.
 अबिज्ज *abijj*, 1078.
 अबुआव *abuāv*, 1201.
 अबो *abon*, 1098.
 अब्बर *abbar*, 800.
 अब्बी *abbi*, 856, 859.
 अब्हेर *abhēr*, 363 (14).
 अब्मखोरा *amkhora*, 690.
 अमन्ना *amta*, 1183, 1456.
 अमन्ना भवानी *amta bhawāni*, 1456.
 अमन्दी *amdi*, 1274.
 अमन्ना *amna*, 1456.
 अमन्रोरा *amrora*, 1183.

अमन्ला *amla*, 1255.
 अमन्नी घोटन *amlo ghotan*, 1310.
 अमण्ठी *amānṭhi*, 1272.
 अमण्ठी के रोटी *amānṭhi ke roti*, 1272.
 अमारौ *amāri*, 852.
 अमाल *amāl*, 345.
 अमाल्ह *amālḥ*, 345.
 अमावट *amāwat*, 1272.
 अमावस *amāwas*, 1088.
 अमीन *amin*, 913.
 अमेडी *ameri*, 191.
 अमेडी *amerhi*, 169.
 अमोट *amot*, 1272.
 अम्बिका भवानी *ambika bhawāni*, 1456.
 अम्बित *amrit*, 1023.
 अरई *arāi*, 101.
 अरन्कसिया *arkasiya*, 395.
 अरन्कौच *arānch*, 1272.
 अरख *arakh*, 1033.
 अरगनी *argani*, 464, 649.
 अरगेनी *argeni*, 649.
 अरग्घा *arḡha*, 775.
 अरज *araj*, 1470.
 अरदरा *aradra*, 967, 1082, 1084,
 1085, 1086.
 अरदाना *ardāna*, 585.
 अरदावा *ardāwa*, 1272.
 अरधी *ardhi*, 1279.
 अरधुधा *ardhua*, 1279.
 अरन्नी *arni*, 414.
 अरपन *arpan*, 1209a.
 अरपा *arpa*, 84.
 अरब्बी *arabbi*, 1061.
 अररा *arra*, 396, 451, 792.
 अरवन *arwan*, 115, 376.
 अरवा *arwa*, 963, 1383.
 अरसो *arsi*, 48, 646.
 अरौच *arānch*, 639.
 अराजी *arājī*, 1470.
 अराठ *arāth*, 940.

अरार *arār*, 792.
 अरारि *arāri*, 792.
 अरिचन *arīan*, 791.
 अरुचा *aruca*, 101, 1061.
 अरुई *arui*, 1061, 1272.
 अरुया *arūya*, 1074, 1183.
 अरुया *arūya*, 33, 101.
 अरुन्दारन *arūcān*, 639.
 अलगनी *algani*, 464, 613.
 अलगरजी *algarji*, 393.
 अलगल *algul*, 1076.
 अलग्ना *alga*, 875.
 अलग्नी *algi*, 799.
 अलङ्ग *alang*, 833, 919, 953.
 अलन्ती *alti*, 1061.
 अलुपजिया *alpujīya*, 1146.
 अलुफी *alphi*, 475.
 अलुव्वाँती *alucānti*, 1398.
 अलावा *alāva*, 1041.
 अलव्वारी *alvāri*, 562.
 अलावे *alāve*, 1041.
 अलाह *alāh*, 868.
 अलुचा *alua*, 1057, 1059.
 अलुई *alūi*, 1057.
 अलुचा *alhua*, 1059.
 अबई *avāi*, 856.
 अवगर *avgar*, 405.
 अवन गवन *avan gavan*, 1294.
 अँवरा *avwara*, 770.
 अवाप्र *avāē*, 26.
 अवारजा *avārja*, 1470, 1471, 1472;
 Appendix, 6a and 12a.
 अवाल *aval*, 345.
 अँवाल *āvāl*, 345.
 अवालू *avālu*, 1264.
 अँवासल *āvāsāl*, 713.
 अँवाँसा *āvānsa*, 882.
 अँवाँसी *āvānsi*, 884.
 अश्रोतन्त्री *ashtotri*, 781.
 अशुकलाद *askalāi*, 611.

असगनी *asgani*, 649.
 असगुन *asgun*, 1454.
 असन्धी *asthi*, 1252.
 असन्धान *asndān*, 1418.
 असन्धान कराप्रब *asndān korācb*, 1418.
 असन्धी *asni*, 996, 1082.
 असफन्गोल *asaphgol*, 1073.
 असन्मान *asmdān*, 585.
 असन्मान तारा *asmdān tāra*, 585.
 असन्मानी *asmdāni*, 1013.
 असन्राप्रब *asrācb*, 25.
 असन्राफ *asraph*, 1317.
 असन्रेखा *asrekha*, 1087.
 असन्रेष *asres*, 1082.
 असल *asal*, 1475, 1479.
 असल के असल *asal ke asal*, 1479.
 असन्लेखा *aslekha*, 1082, 1086.
 असाह *asārh*, 1082.
 असाही *asārhi*, 866, 1009, 1039.
 असाही कोड़ *asārhi kor*, 1009.
 असाही कोड़न *asārhi koran*, 866.
 असाही कोर *asārhi kor*, 866.
 असामियार *asāmiyār*, 1040.
 असामिवार *asāmivār*, 1040.
 असामी *asāmi*, 904, 1215, 1219,
 1461, 1477, 1481.
 असार *asār*, 25, 1265.
 असावरी *asāvari*, 1379.
 असुजन *asujan*, 1354.
 असुजन पत्र *asujan patr*, 1354.
 असेरा *asera*, 1500.
 असेरी *aseri*, 1198.
 अस्तर *astar*, 509, 739.
 अस्तूरा *astūra*, 383.
 अस्थम *astham*, 613, 1259.
 अस्थल *asthal*, 1234.
 अस्थान *asthān*, 1455.
 अस्मान *asmasān*, 1418, 1421.
 अस्मान पूजा *asmasān pūja*, 1421.
 अस्विनी *asvini*, 1082.

अहरा *ahra*, 833, 919.
 अहरी *ahri*, 365, 833, 919.
 अहवाह *ahwāh*, 1172.
 अहिघाती *ahiyāti*, 1277.
 अहिवाती *ahivati*, 1277.
 अहार *ahār*, 233.
 अहोर *ahir*, 1150, 1160.

अहीर केँ घू *ahir ke ghyu*, 1160.
 अहुरा *ahura*, 1294.
 अहुरा बहुरा *ahura bahura*, 1294.
 अहुरा *ahura*, 882.
 अहोर *ahor*, 1294.
 अहोर बहोर *ahor bahor*, 1294.

॥ आ ā ॥

आइ पाइ *āi pāi*, 362a.
 आइल *āil*, 833, 1294.
 आइल गैल *āil gail*, 1294.
 आइलि *āili*, 740.
 आउर *āur*, 904.
 आग्रन *āen*, 81.
 आग्रल *āel*, 1234.
 आओन *āön*, 160.
 आक *āk*, 167, 170, 172, 174, 178,
 179, 181, 183, 184, 185, 188,
 190, 191, 200, 203, 204, 221,
 222.
 आँकड़ *ānkar*, 794, 1266.
 आँकुठ *ānkuth*, 408.
 आँकुस *ānkus*, 102.
 आँख *ānkā*, 172, 1009, 1010, 1057.
 आखरी *ākhri*, 1007.
 आखा *ākha*, 128.
 आखा *ānkha*, 128.
 आखि *ānkhi*, 1009, 1057.
 आग *āg*, 172, 1075.
 आगन्दाइन *āgdāin*, 889.
 आंगन *āngan*, 1237, 1306, 1377,
 1430.
 आगर *āgar*, 1250.
 आगल *āgal*, 1250.
 आगा *āga*, 1008.
 आगी *āgi*, 1416, 1419.
 आगी देब *āgi deb*, 1416.
 आगि बैताल *āgi baitāl*, 1458.

आगि मोल लेब *āgi mol leb*, 1419.
 आगिल *āgil*, 1089.
 आंगी *āngi*, 607.
 आगू *āgu*, 1234.
 आगे *āge*, 1089.
 आघी *āghi*, 1475.
 आँघी *ānghi*, 607.
 आचन्मनी *āchmani*, 774.
 आँचर *ānchar*, 741.
 आँकी *ānchi*, 1248.
 आँजुर *ānjur*, 912.
 आटा *āta*, 1272.
 आँटा *ānta*, 1272.
 आँटी *ānti*, 862, 864, 884, 886, 886n,
 894, 982.
 आँठिल *ānthil*, 1183.
 आँठी *ānthi*, 1272.
 आँठी के रोटी *ānthi ke roti*, 1272.
 आड़ा *āra*, 853, 1247.
 आदक *ārhak*, 89.
 आड़ा *ārha*, 914.
 आँतर *āntar*, 838, 1050.
 आतश्बाज *ālashbāj*, 580.
 आतसबाज *ātasbāj*, 580.
 आँती *ānti*, 1173.
 आँती चढ़ जाग्रब *ānti churh jurb*,
 1173.
 आँती बड़ब *ānti barhab*, 1173.
 आद *ād*, 1073.
 आदमी *ādami*, 1274 (footnote).

- चारि *adi*, 1085.
 चारी *adi*, 1073.
 चारीचक *āchikak*, 1063.
 चादो *ādo*, 1399
 चादो गूड़ *ādo gūr*, 1399.
 चाधा *ādha*, 823, 1053, 1088, 1089, 1092, 1139.
 चाधा डोली *ādha dholi*, 1053.
 चाधा फारी *ādha phāri*, 1139.
 चाधी *ādhi*, 1087.
 चाधी रात *ādhi rāt*, 1087.
 चाधेचाध *ādheādhe*, 1214.
 आन *ān*, 81, 1090, 1113, 1263.
 आना *āna*, 81, 741, 1496
 आपा *āpa*, 646.
 आपत *āpat*, 1080.
 आबन्कार *ābkār*, 371.
 आबा *āba*, 732.
 आबादी *ābādi*, 1183
 आबि *ābi*, 922.
 आबी *ābi*, 370.
 आबी सोरा *ābi sora*, 370.
 आभा *ābha*, 64, 1172.
 आभी *ābhi*, 27.
 आम *ām*, 814, 999 (footnote); Appendix, 14.
 आम के बगैचा *ām ke bagaicha*, 814.
 आमन्दनी *āmḍani*, 1488.
 आमिल *āmil*, 1272.
 आर *ār*, 101, 414, 482, 828, 829, 832, 833, 1147.
 आरत *ārat*, 1332.
 आरती *ārti*, 780, 1332.
 आरन *āran*, 414.
 आरणी *ārni*, 48, 605, 769.
 आरा *āra*, 154, 396, 828, 831, 1247.
 आराकस *ārākas*, 395.
 आरागज *ārāgaj*, 154.
 आरि *āri*, 833, 834, 865.
 आरिक्क *ārūk*, 834
 आरि छाठव *āri chhātav*, 865.
 आरी *āri*, 396, 470, 471, 474, 583, 828, 833.
 आरी चास *āri chās*, 828.
 आरू *āru*, 1057.
 आल *āl*, 833, 1042, 1044.
 आलन *ālan*, 1251.
 आलू *ālu*, 1057.
 आलो *ālo*, 877.
 आव *au*, 3.
 आवः *āva*, 957.
 आवट *āvat*, 1272, 1342.
 आवत *āvat*, 1084.
 आवन *āvan*, 160.
 आवा *āva*, 577, 1262.
 आवँ *āvān*, 1262.
 आवे *āve*, 957.
 आस *as*, 1088, 1091.
 आसणी *āsni*, 773.
 आसऱिक *āsriḱ*, 1457.
 आसा *asa*, 1192.
 आसा चास *āsa chās*, 1192.
 आसिन *āsin*, 1082, 1087.
 आसी *āsi*, 884.
 आस *ah*, 414.
 आहर *āhar*, 919, 953.
 आङ्गल *āhul*, 882.

॥ इ ॥

- इकन्डी *ikri*, 1266.
 इकन्डी *inkri*, 794, 1266.
 इकऱी *ikri*, 815, 1050.
 इक्कर *ikkar*, 815.
 इङ्गऱौटे *ingrauti*, 662.
 इङ्गुरी *inguri*, 1272.

ईगूर *ingūr*, 1272.
 इजार *ijār*, 727, 743.
 इजार बन्ध *ijār band*, 743.
 इजारा *ijāra*, 1210.
 इची *inchi*, 1034.
 इतिवार *itibār*, 1451.
 इन्द्रा *indra*, 920.
 इंदारा *indāra*, 920.
 इनताफा *intāpha*, 1475.
 इनतिफा *intipha*, 1475.
 इनाम *inām*, 1194, 1205, 1209d,
 1217.
 इनानात *ināmāt*, 1209d.
 इनार *inār*, इनारा *ināra*, 920.
 इन्सी *insi*, 1034.
 इमरिती *imviti*, 1272.
 इमलपत्ती *imalpatti*, 748.

इमन्ली *imli*, 1310, 1314.
 इमन्ली घोंटार *imli ghoṅtāi*, 1310,
 1314.
 इमाम *imām*, 706.
 इमाम जिस्ता *imām jista*, 706.
 इमाम्बारा *imāmbāra*, 1379.
 इमिरन्ती *imirti*, 1073, 1272.
 इरादा *irāda*, 1465.
 इलाहची *ilāhī*, 1272.
 इलाहची दाना *ilāhī dāna*, 1272.
 इलाम *ilām*, 1217.
 इलाही *ilāhi*, 1491.
 इलाही गज *ilāhi gaj*, 1491.
 इमरिती *istiri*, 389.
 इस्तमरारी *istamrāri*, 1215.
 इस्तिरी *istiri*, 1275.
 इहै *ihai*, 1088.

॥ इ i ॥

ई i, 128 (footnote), 240, 394, 741,
 1088, 1113, 1183.
 ईकर *inkar*, 1051.
 ईगूर *ingur*, 747.
 ईंट *nt*, 1263.

ईटा *ita*, 1263.
 ईंटा *inta*, 367, 1263, 1264.
 ईस *is*, 5.
 ईसान *isān*, 1087.

॥ उ u ॥

उकान्त *uktan*, 1342.
 उकान्ठा *uktha*, 1004, 1074.
 उकान्हा *ukrha*, 1074.
 उकरी *ukri*, 564.
 उकसा *uksa*, 1074.
 उकाम *ukām*, 892.
 उकाँव *ukāñv*, 892.
 उकुम *ukum*, 892.
 उकन्ठा *ukhtha*, 1074.
 उखड़ *ukhar*, 1486.
 उखड़ हाल *ukhar hāl*, 827.
 उखड़ा *ukhra*, 1075.

उखड़ि *ukhari*, 1486.
 उखण्बधना *ukhbandhna*, 120.
 उखर जाग्रव *ukhar jāgṛb*, 1174.
 उखरा *ukhra*, 1074.
 उखरी *ukhri*, 24, 612.
 उखली *ukhli*, 431.
 उखारी *ukhari*, 805, 1006.
 उखाव *ukhao*, 805.
 उखाँव *ukhāñv*, 805, 1006.
 उखेवा *ukheva*, 919.
 उखेनो *ukhaino*, 76.
 उखौता *ukhauta*, 431.

- उग *ug*, 1087.
 उगन्टन *ugtan*, 1342.
 उगलन्दान *ugaldān*, 707.
 उगै *ugai*, 1091.
 उघेन *ughen*, 115.
 उचन्का *uchka*, 1259.
 उचन्कुन *uchkun*, 464.
 उचन्ली *uchli*, 792.
 उचन्वड़ *uchwar*, 1256.
 उचाव *uchās*, 790.
 उचन्टनी *uchhtani*, 867.
 उचाड़ी *uchhāri*, 1436.
 उजड़ *ujar*, 796.
 उजःकुा *ujra*, 796.
 उजरन्का *ujarka*, 1059.
 उजरन्ल *ujral*, 796.
 उजःरा *ujra*, 1147.
 उजागर *ujāgar*, 965b.
 उजाड़ *ujār*, 796.
 उज्जा *ujjha*, 1147.
 उज्जलन *ujhlan*, 866, 867.
 उज्जिला *ujhila*, 1272.
 उटकन *utkan*, 705, 1342.
 उटन्रा *utra*, 193, 959.
 उठा *uttha*, 842.
 उठ *uth*, 1113.
 उठन्ती *uthti*, 799, 1229.
 उठन्ती परन्ती *uthti parti*, 1229.
 उठाप्रब *uthāēb*, 1030, 1333.
 उठान *uthān*, 1087, 1090, 1439.
 उठानो *uthāno*, 1094.
 उठाबैक *uthābaik*, 1234.
 उठौनिहार *uthaunihār*, 1030.
 उठौनिहारिन *uthaunihārin*, 1030.
 उड़ाइ *urāi*, 1320.
 उड़ाओल *urāöl*, 713.
 उड़ाहब *urāhub*, 713.
 उरह *urharh*, 376.
 उरहवा *urhrha*, 233
 उरहरी *urharhi*, 1280.
 उरहरी *urhari*, 1280.
 उहाप्रब *urhāēb*, 713.
 उतर *utar*, 1485.
 उतरन्त *utrāt*, 1085.
 उतरन्ना *utarna*, 764.
 उतरन्रा *utra*, 1082, 1088.
 उतरन्रा खाढ़ *utra khārḥ*, 1082.
 उतरन्रा फयुनी *utra phaguni*, 1082.
 उतरःरी *utri*, 1418.
 उतसरन्ग *utsary*, 1459.
 उतारब *utārab*, 1420.
 उतारा *utāra*, 1457.
 उतारा पतारा *utāra putāra*, 1457.
 उत्तर *uttar*, 1082.
 उत्तर भद्रपद *uttar bhadrpad*, 1082.
 उदङ्गर *udangar*, 1147.
 उदन्त *ulant*, 1118.
 उदन्राह *udrāchh*, 755.
 उदह *udah*, 919.
 उदह के पानी ले जाप्रब *udah ke pānī le jāēb*, 919.
 उदै *udai*, 1087.
 उधान *udhān*, 301.
 उधार *udhār*, 1476.
 उनन्टा चिरन्चिरी *unta chirchiri*, 1183.
 उनाह *unāh*, 826.
 उपन्जय *upjay*, 1087.
 उपजे *upaje*, 829, 1087.
 उपन्टा *upta*, 918.
 उपन्टार *uptār*, 1088.
 उपर *upar*, 11.
 उपरन्कर *uparkar*, 363.
 उपरन्कट्टी *uparchhatti*, 1245.
 उपर पाटो *upar pāto*, 11.
 उपरन्वार *uparwār*, 790.
 उपन्रार *uprār*, 790.
 उपन्रौटा *uprauta*, 620, 1250.
 उपन्रौटा *upraunta*, 1251.
 उपन्रौड़ *uparaur*, 1113.
 उपारन्जित *upārjit*, 1215.

उर्फंजिया *uphangiya*, 844.
 उबन्टन *ubtan*, 1308, 1314, 1340,
 1342, 1368.
 उबन्हन *ubhan*, 115.
 उबहनि *ubahani*, 116, 930.
 उबहनी *ubhani*, 115.
 उबहैन *ubhain*, 115.
 उबेर *uber*, 1147.
 उबेरा *ubera*, 1147.
 उभर *ubhar*, 792.
 उभर खाभर *ubhar khābar*, 792.
 उम्मी *ummi*, 877, 990.
 उरकुस्सी *urkussi*, 1075.
 उरन्ता *urta*, 585c.
 उरन्ता पेटाड़ा *urta petārka*, 585c.
 उरन *uran* 585c.
 उरन पेटाड़ा *uran petārka*, 585c.
 उरन्फी *urphi*, 1361, 1363.
 उरन्मा *urma*, 748.
 उरिद *urid*, 996.

उरन्दी *urdi*, 996.
 उलन्डल *ullal*, 1486.
 उलन्टा *ulta*, 749.
 उलन्टा मुण्डा *ulta mundka*, 749.
 उलन्दी *ulti*, 475.
 उलन्दी चीन *ulti chīn*, 475.
 उलन्दी *uldi*, 714.
 उलबन्ना *ularna*, 195.
 उलन्वा *ulwa*, 1272.
 उलन्वा दाल *ulwa dāl*, 1272.
 उलँक *ulānk*, 230.
 उलावल *ulawal*, 1272.
 उलावल दाल *ulawal dāl*, 1272.
 उस *us*, 655.
 उसन्ना *usna*, 963.
 उसन्ना *usra*, 1242.
 उमिना *usina*, 963.
 उसठ *usath*, 800.
 उस्सर *ussar*, 816.

॥ अ ū ॥

ऊ *ū*, 568, 1088.
 ऊख *ūkh*, 1005, 1006, 1008.
 ऊख (or केतारी) के खेत *ūkh (or ketāri)*
ke khet, 1006.
 ऊखर *ukhar*, 792.
 ऊखर खावड़ *ūkhar khābar*, 792.
 ऊखि *ūkhi*, 1005.
 ऊगहिँ *ūgahīn*, 1087.
 ऊगे *ūge*, 1091.
 ऊँच *ūnch*, 792, 829.
 ऊँच खाल *ūnch khāl*, 792.
 ऊँठ *ūṭ*, 1131.

ऊड़े *ūre*, 1088.
 ऊना *ūna*, 828.
 ऊना डेही जोत *ūna derhi jot*, 828.
 ऊना थोही जोत *ūna dhyorhi jot*, 828.
 ऊना फानी *ūna phāni*, 828.
 ऊनी *ūni*, 877, 990.
 ऊबर *ūbar*, 792.
 ऊबर खाबर *ūbar khābar*, 792.
 ऊमी *ūmi*, 877, 990, 1272.
 ऊरस *ūras*, 1441.
 ऊलुस *ūlus*, 1271.
 ऊसर *ūsar*, 816.

॥ ए e ॥

एक *ek*, 625, 817, 904, 1070, 1085,
 1118, 1234.

एकगोटिया *ekgotiya*, 639.
 एकचारा *ekchāra*, 1245.

- एकचारी *ekchāri*, 1245.
 एक चास *ek chās*, 823.
 एकचपरा *ekchhapra*, 1245.
 एकजोरिया *ekjoriya*, 639.
 एकठा *ektha*, 35, 232, 527, 538,
 705.
 एक तौल *ek taul*, 1118.
 एकपट्टा *ekpatta*, 730.
 एकपालिया *ekpaliya*, 1245.
 एकफसिला *ekphasila*, 803.
 एकफसिली *ekphasili*, 803.
 एकबधिया *ekbadhiya*, 639.
 एक बाँह *ek bāñh*, 817.
 एकराङ्गा *ekraṅga*, 1379, 1381.
 एकरी *ekri*, 1272.
 एकरी *enkri*, 1272.
 एकलाइ *eklāi*, 730.
 एकलाता *eklauta*, 1397.
 एकवाइ *ekwāi*, 524, 531, 549.
 एकसलिया *eksaliya*, 803.
 एक साल के तौल *ek sāl ke taul*, 1118.
 एकसिङ्गा *eksingha*, 1108.
 एकहत्थु *ekhatthu*, 510.
 एकहत्थु भाथी *ekhatthu bhāthi*, 510.
 एकहत्थी *ekhanthi*, 414.
 एक हरा *ek hara*, 31.
 एकहरा *ekahra*, 1250.
 एकहुला *ekahula*, 1397.
 एकाबे *ekābe*, 524.
 एकैसिया *ekaisiya*, 884.
 एकैसी *ekaisi*, 884, 885.
 एको *eko*, 1090.
 एकौनियाँ *ekauniyān*, 1397.
 एकौज *ekauj*, 1398.
 एकौल्हा *ekaulha*, 1247.
 एका *ekka*, 148, 228.
 एके *ekke*, 964.
 एकराजात *ekhrājāt*, 1207.
 एगन्दौँ *egdāin*, 889.
 एगना *engna*, 1237.
 एघाय *eghāy*, 952.
 एघाँ *eghāñ*, 951, 952.
 एघावा *eghāwa*, 952.
 एतेक *etek*, 1451.
 एदली *edli*, 967a.
 एह *eh*, 1088.
 एहवाती *ehwāti*, 1277.
 एहि *ehi*, 1002 (footnote), 1113.

॥ ए e ॥

एक *ek*, 1084.| एडा *era*, 29, 89, 185, 195.

॥ ऐ ai ॥

ऐँहवा *ainthua*, 756, 769.: ऐडवा *airha*, 726.

॥ ऐ ai ॥

ऐँटा *ainta*, 1263.ऐँठन *ainthan*, 115 (footnote).ऐँठल *ainthal*, 123.ऐँठल रस्सी *ainthal rassi*, 123.ऐठा *aitha*, 1267.ऐँठा *aintha*, 1267.ऐन *ain*, 1221.ऐला *aila*, 1248.

ऐली *aili*, 1275.
ऐसन *aisan*, 1088.

ऐसी *aisi*, 655.
ऐहब *aihab*, 1277.

॥ ओ ० ॥

ओँकड़ा *onkra*, 412.
ओँखरा *okhra*, 616.
ओखरी *okhri*, 431, 464, 612, 616.
ओखला *okhla*, 431.
ओखली *okhli*, 464, 616.
ओगरा *ogra*, 1272.
ओहाओन *ochhāon*, 637.
ओहौना *ochhawna*, 637.
ओहाइ *ojhāi*, 1453.
ओटनी *otni*, 1017.
ओटाइ *otāi*, 1017.
ओठगन *othgan*, 1259.
ओठगनी *othyani*, 1259.
ओड़िया *oriya*, 43, 288.
ओइसा *ovaisa*, 44, 93.
ओहना *orhna*, 133.
ओहनी *orhni*, 745.
ओहौल *orhaul*, 1457.
ओदनाइन *odcāin*, 639.
ओदाइन *odāin*, 639.
ओदान *odān*, 639.

ओनचन *onchan*, 639.
ओपनी *opni*, 536.
ओबटन *obtan*, 1342.
ओरचन *orchan*, 244, 633.
ओरद्वानी *orduwāni*, 639.
ओरदावन *ordāoun*, 244.
ओरहा *orha*, 877, 957, 984, 990,
1272.
ओरिग्यानी *oriyāni*, 1252.
ओलनी *olti*, 1252.
ओलवारी *ohrāri*, 562.
ओसरा *osra*, 1242.
ओसरो *osro*, 1242.
ओसाप्रब *osāpōb*, 897.
ओसारा *osāra*, 1242.
ओसारी *osāri*, 1242.
ओसांनी *osauni*, 319n, 897.
ओहाप्रब *ohāeb*, 1115.
ओहार *ohār*, 216, 554.
ओहारी *ohāri*, 490, 1252.
ओसा *osta*, 383.

॥ ओ ० ॥

ओ ०, 964, 1088, 1092, 1383.
ओकर *okar*, 1486.
ओकर टाट उलटल है *okar tāt
ultal hai*, 1486.
ओका *oka*, 646.
ओखर *okhar*, 489, 612, 616.
ओभा *ojha*, 639, 1453.
ओटब *otab*, 1017.
ओँटब *ontab*, 1017.

ओटा *ota*, 78, 722, 1243.
ओड़ा *ora*, 43, 44.
ओड़ी *ori*, 43, 288, 308.
ओतब *otab*, 1246.
ओध *odh*, 814.
ओर *or*, 964, 1088.
ओरी *ori*, 1183, 1252.
ओरी टीनी *ori timi*, 1183.
ओसर *osar*, 1118.

॥ औ au ॥

औंजली *aujli*, 1436.
औंटाइ *autāi*, 1017.

औल्हा *aulha*, 882.

॥ औ au ॥

औ *au*, 1217.
औआ बौआ *aua baua*, 1088.
औंकर *aunkar*, 1183.
औंगर *augār*, 26.
औंखव *aunchhab*, 1402.
औंठी *authi*, 756, 769.

औदार *audār*, 1098.
औंधा *aundha*, 1262.
औरङ्ग *aurang*, 1074.
औरा *aura*, 1294.
औरा बौरा *aura baura*, 1294.

॥ क k ॥

कं *kañ*, 1451.
ककड़ी *kakri*, 1070.
ककड़ी *kankri*, 1266.
ककना *akna*, 768, 1075.
कंकना *kankna*, 768.
कंकनी *kankni*, 768.
कंकराही *kankrahi*, 794.
कंकरी *kankri*, 1087.
कक्रेजा *kakreja*, 742.
ककरोटिया *kankrotiya*, 794.
ककवा *kakva*, 747.
ककहा *kakha*, 747.
ककही *kakhi*, 747.
ककीर *kakir*, 1049.
ककेर *kaker*, 1049.
ककंगड़ा *kangra*, 1033.
ककंगना *kangna*, 768, 1378.
ककंगना बांधव *kangna bāndhab*, 1378.
ककंगनिया *kanganiya*, 792.
ककंगनी *kangni*, 571.
ककगमुहूँ *kagmuhūn*, 516.
ककगही *kangahi*, 747.
ककचरा *kachra*, 768.
ककङ्क *kankar*, 794, 1266.
ककङ्कन *kankan*, 1323.

कङ्कन *kangan*, 1323.
कककोह *kachkoh*, 1264.
ककचरस *kachras*, 1014, 1272.
ककचरा *kachra*, 768, 1004.
ककचरी *kachri*, 877, 1004, 1042, 1265.
ककचरुखी *kachrukhi*, 558.
ककचवनिया *kachvaniya*, 1272.
ककचिया *kachiya*, 73b.
ककचुष्वा *kachua*, 1052.
ककचौरा *kachora*, 677.
ककचोहा *kachoha*, 1074.
ककचौड़ा *kachauri*, 1272.
ककचौरी *kachauri*, 1002 (footnote).
ककचौस *kachaus*, 786.
ककचक *kachhak*, 399.
ककचा *kachcha*, 877, 920b, 1235, 1263,
1492, 1495, 1497.
ककचा कोस *kachcha kos*, 1492.
ककचा पक्का *kachcha pakka*, 1235.
ककचा बिगन्हा *kachcha bigha*, 1495.
ककची *kachchi*, 1499.
ककची रत्ती *kachchi ratti*, 1499.
ककचु *kachchu*, 1061.
ककचा *kachehha*, 1418, 726.
ककचाड़ *kachhār*, 792.

- कक्षाड़ा *kachhāra*, 792.
 कक्षुइया *kachhuiya*, 786.
 कजई *kajai*, 96.
 कजरग्वरो *kajargharo*, 970.
 कजररा *kajra*, 1074.
 कजऱरी *kajri*, 969b, 977, 1074, 1183.
 कजऱरौटा *kajrauta*, 747.
 कजऱरौटी *kajrauti*, 747.
 कगऱला *kajla*, 1074, 1183.
 कञ्जक *kajjak*, 399.
 कञ्चन *kanchan*, 977.
 कञ्चन चुर *kanchan chūr*, 977.
 कञ्चन पूरी *kanchan pūri*, 679.
 कञ्चा *kancha*, 1235.
 कञ्चा पका *kancha pakka*, 1235.
 कञ्चो *kanchho*, 1014.
 कञ्चो रस *kanchho ros*, 1014.
 कङ्गर *kanjar*, 594.
 कटङ्किरा *katkira*, 533.
 कटङ्गना *katna*, 569.
 कटङ्गनियँ *katniyān*, 874.
 कटङ्गनिहार *katnihār*, 874, 886 (foot-note).
 कटङ्गी *katni*, 574, 873, 874, 1024.
 कटङ्गनी *katarni*, 482.
 कटङ्गा *katua*, 1175.
 कटङ्गसर *katsar*, 765.
 कटङ्गहर *kathar*, 1405.
 कटङ्गरा *kathra*, 228.
 कटङ्गरी *katāri*, 131.
 कटङ्गिया *kantiya*, 136, 140, 432, 442, 713, 1422.
 कटङ्गिया *katiya*, 136, 713, 873.
 कटङ्गा *katua*, 894, 990, 994, 995, 997.
 कटङ्ग *katui*, 875, 1074, 1163.
 कटङ्ग दही *katui dahi*, 1163.
 कटङ्गो *katuo*, 994, 995.
 कटङ्गो *kantelo*, 95.
 कटङ्गसर *katesar*, 765.
 कटङ्गया *kataiya*, 1074.
 कटङ्गइया *katōiya*, 1074.
 कटङ्ग *katoī*, 1074.
 कटङ्गोरा *katōra*, 449, 677, 678, 711.
 कटङ्गोरी *katōri*, 383, 535, 553, 778.
 कटङ्गा *katta*, 1144, 1456.
 कटङ्गा *kattha*, 1495.
 कटङ्ग *kath*, 414.
 कटङ्गथऱरी *kathathri*, 576.
 कटङ्गई *kathāi*, 136, 137.
 कटङ्गका *kathka*, 390.
 कटङ्गकिरा *kathkira*, 533.
 कटङ्गकिल्ली *kathkilli*, 179.
 कटङ्गकूँआँ *kathkūān*, 924.
 कटङ्गखऱपी *kathkharpi*, 305, 306.
 कटङ्गनही *kathnahi*, 929.
 कटङ्गबन्धन *kathbandhan*, 1130.
 कटङ्गबेटा *kathbeta*, 1279.
 कटङ्ग भँथी *kath bhān̄thi*, 414.
 कटङ्गरा *kathra*, 93, 226, 430, 442, 462, 543, 584, 714, 1131.
 कटङ्गरङ्गनी *kathrangni*, 1075.
 कटङ्गला *kathla*, 226.
 कटङ्गली *kathli*, 136, 714.
 कटङ्गवत *kathvat*, 39, 319n, 462.
 कटङ्गही *kathahi*, 305.
 कटङ्गा *katha*, 1194.
 कटङ्गधर *kathādhār*, 913.
 कटङ्गार *kathār*, 1058.
 कटङ्गरी *kathāri*, 782.
 कटङ्गली *kathuli*, 39, 714.
 कटङ्गोली *katholi*, 714.
 कटङ्गोआ *kathaua*, 64.
 कटङ्गौत *kathaut*, 319n, 584, 714.
 कटङ्गौता *kathauta*, 319n.
 कटङ्गौती *kathauti*, 319n, 430, 442, 462, 543, 584, 714.
 कटङ्गौर *kathaur*, 328.
 कटङ्गड़ा *karra*, 852.
 कटङ्गड़ा *kanrra*, 852.

कङ्गरा *kanra*, 848.
 कङ्करू *karru*, 1120.
 कङ्गवा *karwa*, 233.
 कङ्गवा *kanra*, 233.
 कङ्गवानौ *kanrañi*, 815.
 कङ्गहड्डी *karhari*, 169, 179.
 कङ्गहा *karha*, 140.
 कङ्गहाइ *karhāi*, 455, 506, 584.
 कङ्गही *karhi*, 140.
 कङ्गा *kara*, 226, 455, 673, 757, 759,
 771, 936, 1406.
 कङ्गाइ *karāh*, 285, 308, 671.
 कङ्गाही *karāhi*, 138, 455, 465, 506,
 563, 673, 936.
 कङ्गिया *kariya*, 455.
 कङ्गिया *kauriya*, 431.
 कङ्गी *kari*, 35, 169, 223, 233, 936,
 1258.
 कङ्गुआ *karua*, 1023.
 कङ्गुओ *karuo*, 1023.
 कङ्गुनी *karhni*, 319k.
 कङ्गाइ *karhāi*, 430.
 कङ्गुआ *karhūa*, 1272, 1290.
 कङ्गुर *karhūi*, 1290.
 कङ्गौर *karhaur*, 1475.
 कण्टा *kanta*, 37, 328, 935.
 कण्टाहा *kantaha*, 1425.
 कण्ठ *kanth*, 29.
 कण्ठा *kantha*, 226, 749, 755, 1173.
 कण्ठार *kanthār*, 1173.
 कण्ठा रोग *kantha rog*, 1173.
 कण्ठा सारू *kantha sārū*, 1173.
 कण्ठी *kanthi*, 29, 1429.
 कण्ठा *kanda*, 848, 852.
 कतई गज *katai gaj*, 1491.
 कतथ *katay*, 1087.
 कतरनी *katarni*, 588.
 कतरपारा *katarpāra*, 292.
 कतरबहा *katarbaha*, 294.
 कतरवाह *katarwāh*, 294.

कतरवाहा *katarwāha*, 294.
 कतरा *katra*, 362a, 403, 497, 1183.
 कतरा के जड़ *katra ke jar*, 362a.
 कतरिवाह *katariwāh*, 294.
 कतरि *katari*, 403.
 कतरौ *katri*, 255, 258, 272, 278,
 558, 768, 1074.
 कतरौ *kantri*, 138.
 कतरौही *katrohī*, 403.
 कतला *katla*, 497.
 कतवा *katwa*, 768.
 कतिका *katika*, 967b, 996.
 कतिकौ *katiki*, 1039.
 कतेक *katek*, 1085.
 कत्ता *katta*, 74.
 कत्ती *katti*, 713, 1491.
 कत्ती गज *katti gaj*, 1491.
 कथ *kath*, 1073.
 कथा *katha*, 1286.
 कथा करब *katha karab*, 1286.
 कदई *kudai*, 788, 789.
 कदम *kudam*, 585, 1492, 1495.
 कदमक *kadamak*, 726 (note).
 कदम गाह *kudam gāchh*, 585.
 कदरौ *kandri*, 920.
 कदवा *kadwa*, 824, 981, 1399.
 कदीमा *kadima*, 1071.
 कदीमी *kadimi*, 1215.
 कदुआ *kadua*, 1068.
 कदुरौ *kanduri*, 1369, 1377.
 कदुठ *kudath*, 579.
 कदुद *kudoi*, 787, 788, 789.
 कदु *kaddu*, 1068.
 कंधावर *kandhāwar*, 1348.
 कंधेला *kandhela*, 363.
 कन *kan*, 913, 1052, 1062.
 कनई *kanai*, 1024.
 कनक *kanak*, 972, 978.
 कनक चूर *kanak chūr*, 978.
 कनक जौर *kanak jūr*, 972.

- कनकजीरा *kanakjira*, 974.
 कनकठिया *kankathiya*, 1416.
 कनकपुरिया *kanakpuriya*, 1057.
 कनकिल्ली *kankilli*, 15.
 कनकुत्ती बटार *kankutti batāi*, 913.
 कनकूत *kankūt*, 913.
 कनखी *kankhi*, 1011.
 कनगोजर *kangojar*, 1010.
 कनगम्प्या *kanjhappa*, 725.
 कनगम्प्या *kanjhappi*, 725.
 कनगम्पो *kanjhappo*, 725.
 कनगम्पोपा *kanjhopa*, 725.
 कनगटोप *kantop*, 725.
 कनग्तोर *kantor*, 656.
 कनफूल *kanphūl*, 764.
 कनब *kanab*, 913.
 कनबडा *kanbada*, 967c.
 कनबाला *kanbāla*, 753.
 कनवई *kanvāi*, 1497.
 कनवह *kanvah*, 954.
 कनवा *kanva*, 954, 1173, 1183.
 कनवाँ *kanvān*, 1054, 1075, 1491,
 1497, 1498.
 कनसन *kansan*, 1075.
 कनसार *kansār*, 434.
 कनसारी *kansāri*, 434.
 कनसी *kansi*, 1001, 1010.
 कनरल *kanāil*, 1011.
 कनाठ *kanāth*, 864.
 कनाठा *kanātha*, 1074.
 कनासी *kanāsi*, 403.
 कनार *kanār*, 102.
 कनाह *kanāh*, 1011.
 कनाहा *kanāha*, 1011.
 कनिएली *kaniaēli*, 1348.
 कनिक *kanik*, 1272.
 कनियाएल *kaniyāēl*, 957, 1018.
 कनियाएल आवः है *kaniyāēl āva hai*,
 957.
 कनिल *kanil*, 797.
 कनिसार *kanisār*, 434.
 कनेसाँ *kanēān*, 741, 1282, 1328.
 कनेसार *kanēāi*, 1322, 1327.
 कनेसाँ दान *kanēān dān*, 1328, 1329,
 1330, 1346.
 कनेटा *kaneta*, 1251.
 कनेटी *kaneti*, 929.
 कनेल *kanail*, 15, 194, 275, 938, 1024.
 कनेली *kanaili*, 275, 363, 764.
 कनोजर *kanojar*, 1010, 1011.
 कनौसी *kanāusi*, 20, 753, 764.
 कन्त *kant*, 568, 1113.
 कन्ता *kanta*, 1087.
 कन्दई *kandāi*, 1023.
 कन्दा *kanda*, 1061.
 कन्दी *kandi*, 373.
 कन्धा *kandha*, 274.
 कन्ना *kanna*, 404, 455, 933, 940,
 1075, 1183.
 कन्नी *kanni*, 933, 957.
 कन्याइन *kanyāin*, 1282.
 कन्सी *kansi*, 451.
 कन्हावर *kanhāwar*, 1348.
 कन्हिया *kanhiya*, 274.
 कन्ही *kanhi*, 1074.
 कन्हेली *kanheli*, 125, 126, 275.
 कपःहेरी *kapēheri*, 485.
 कपःटा *kapta*, 1074.
 कपःटी *kapti*, 713.
 कपःडा *kopra*, 393, 723, 1402.
 कपःडा लत्ता *kapra lattā*, 723.
 कपरःधूर *kapardhūr*, 607.
 कपरःनी *kaparni*, 363.
 कपरःबिन्नी *kaparbinni*, 363.
 कपरःबीनी *kaparbinī*, 363.
 कपःरौट *kapraut*, 530.
 कपःरौट *kampraut*, 530.
 कपार *kapāi*, 134, 647, 1145.
 कपार *kapār*, 833.
 कपारी फोरल *kapāri phoral*, 1018.

कपास *kapās*, 1016, 1017, 1018,
 1019, 1089.
 कपास फूटब *kapās phūtab*, 1018.
 कपूरी *kapūri*, 1049.
 कप्पा *kappa*, 726.
 कप्पा *kappa*, 1032.
 कफगीर *kaphgīr*, 450.
 कफचा *kaṣha*, 450.
 कफनाग्रब *kaphnāḅ*, 1418.
 कफनी *kaphni*, 1418, 1431.
 कफा *kapha*, 1032, 1033.
 कव *kab*, 1275.
 कवज *kabaj*, 1467.
 कवजाना *kabhāna*, 1198.
 कवर *kabr*, 1431.
 कवर खोदाइ *kabr khodāi*, 1431.
 कवरिया *kabariya*, 864.
 कवरिस्तान *kabristān*, 1431.
 कवरिहा *kabariha*, 864.
 कबला *kabla*, 416, 417.
 कबली *kabli*, 1000.
 कबा *kaba*, 729.
 कबाब *kabāb*, 447.
 कबाब दानी *kabāb dāni*, 447.
 कबि *kabi*, 655.
 कबिरिहा *kabirha*, 1429.
 कबिला *kabila*, 1275, 1276.
 कबिली *kabili*, 1000.
 कबूली *kabūli*, 963, 1272.
 कम *kam*, 240.
 कमची *kamchi*, 592.
 कमठा *kamtha*, 601.
 कमठी *kamthi*, 576.
 कमठरणा *kamdharna*, 557.
 कम धारा *kam dhāra*, 532.
 कमण्डल *kamandul*, 782.
 कमनगर *kamangar*, 601.
 कमर *kamar*, 655, 1020.
 कमरकस *kamarkas*, 770.
 कमरखोलाइ *kamarkholāi*, 1205.

कमरजेब *kamarjēb*, 770.
 कमरतोइ *kamartoi*, 743.
 कमरथुआ *kamrathua*, 1460.
 कमरपन्थु *kamarpanthu*, 1460.
 कमरबला *kamarballa*, 1257.
 कमरसायर *kamarsāyar*, 407, 394
 कमरसारी *kamarsāri*, 407.
 कमरा *kamra*, 737.
 कमरिया *kamariya*, 737, 1184.
 कमरी *kamri*, 344, 737.
 कमल पतर *kamulpatr*, 1073.
 कमला परसाद *kamla parsād*, 97.
 कामसरे *kamsare*, 1217.
 कामहँड *kamhañḍ*, 363.
 कामहण्डा *kamhaṇḍa*, 363.
 कामहर *kamhar*, 363, 489.
 कामाई *kamāi*, 842, 1194, 11
 1197, 1412.
 कामान *kamān*, 601.
 कामानक *kamānak*, 398.
 कामाना *kamāna*, 538, 1141.
 कामानी *kamāni*, 398, 415, 416, 4
 538.
 कामार *kamār*, 394, 407.
 कामारी *kamāri*, 143.
 कामिचई *kamičai*, 1186.
 कामियाई *kamiyāi*, 842.
 कामियाँ *kamiyān*, 842, 844, 1184
 कामियौटी *kamiyauti*, 1186.
 कामी *kami*, 1217.
 कामीना *kamīna*, 1141, 1217.
 कामुआ *kamua*, 1074.
 कामैताह *kamaitāh*, 394.
 कामैनी *kamāni*, 866, 867, 1194.
 कामोच *kamoch*, 972.
 कामोदी *kamodi*, 978.
 कामोरा *kamora*, 277.
 कामौनी *kamāni*, 866, 867.
 काम्यनी *kampani*, 1202 ; Appendix
 काम्या *kamya*, 381.

कम्पास *kampās*, 419, 519.
 कम्मर *kammar*, 737.
 कम्मल *kammal*, 737.
 कम्पा *kamma*, 1074.
 कम्पैया *kamhaiya*, 915.
 कर *kar*, 363, 1025.
 करई *karāi*, 713.
 करकट *karkat*, 1117.
 करकन्धा *karkandha*, 1138.
 करका *karka*, 786.
 करकुट *karkut*, 329.
 करके *karke*, 1087.
 करखा *karkha*, 69.
 करखाना *karkhāna*, 312.
 करखाहि *karkhāhi*, 69.
 करखाहि हिंदिया *karkhāhi hindiya*,
 69.
 करखी *karkhi*, 69.
 करखो *karkho*, 69.
 करगह *kargah*, 363.
 करंगा *karnga*, 966a.
 करंगी *karngi*, 966b.
 करन्ची *karchi*, 353, 1119, 1308.
 करकुल *karkhul*, 319k, 564, 684.
 करज *karj*, 1461, 1476.
 करज खोर *karj khor*, 1461.
 करज खौक *karj khauk*, 1461.
 करजनी *karjani*, 1499.
 करज्जवाम *karjvām*, 1476.
 करजा *karja*, 1187, 1188, 1190,
 1176.
 करजेन *karjain*, 1191.
 करतली *kartali*, 225.
 करता *karta*, 730, 1394, 1418, 1419,
 1420, 1422, 1423, 1426.
 करता पुत्र *karta putr*, 1394.
 करती मूरी *karti mūri*, 1119.
 करथरी *karthari*, 576.
 करथि *karathi*, 1272.
 करधन *kardhan*, 758.

करधनी *kardhani*, 758, 770.
 करनफूल *karaphul*, 764.
 करना *karna*, 138, 713.
 करनी *karni*, 422.
 करन्त *karant*, 1091.
 करब *karab* 358, 362a, 855, 981,
 1143, 1246, 1286, 1339, 1343,
 1402, 1408, 1416, 1419, 1451,
 1452, 1484.
 करबा *karba*, 356.
 करबार *karbār*, 363.
 करम *karm*, 1128, 1446.
 करमकला *karamkalla*, 1073.
 करमा *karma*, 972.
 करमा धरमा *karma dharma*, 1446.
 करमाला *karmāla*, 781.
 करमिया *karmiya*, 1059.
 करमी *karmi*, 1183.
 करमी लत *karmi lat*, 1183.
 कररुखा *kararua*, 1049.
 करल *karal*, 873.
 करवा *karva*, 432, 713.
 करसी *karsi*, 848, 852.
 करह *karah*, 1090, 1451.
 करहनी *karhanni*, 966c, 966d, 967d,
 969e.
 करहा *karha*, 832, 836, 954.
 करहाइ *karhāi*, 554.
 करहिया *karahiya*, 713.
 करा *kara*, 673.
 कराइ *karāi*, 996, 1084.
 कराब *karāb*, 1408, 1418, 1430.
 करान्त *karānt*, 1496.
 कराबा *karāba*, 372.
 कराम *karām*, 889.
 करार *karār*, 786, 1183.
 कराग *karāga*, 792.
 करा लाब *kara lāb*, 25.
 कराह *karāh*, 285, 308, 312, 319.
 कराह के घर *karāh ke ghar*, 312.

- कराघ घर *karāh ghar*, 324.
 कराहा *karāha*, 285, 319.
 कराही *karāhi*, 308, 319, 673, 711,
 713.
 करिकम्बा *karikandha*, 1138.
 करिखा *karikha*, 69.
 करिखार *karikhāi*, 69.
 करिखार ह्वाँड़ी *karikhāi hāuri*, 69.
 करिंग्वाघ *karīngwāh*, 950.
 करिगघ *karigah*, 356, 363.
 करि देव *kari deb*, 1339.
 करिनन्वाघ *karinwāh*, 950.
 करियवा *kariyawa*, 1113, 1137.
 करिया *kariya*, 996, 1137.
 करिहठ *kariha*, 1113.
 करौंग *karūng*, 950.
 करौन *karūn*, 950.
 कवथा *karua*, 1045, 1137.
 कवथा तेल *karua tel*, 1045.
 कवथार *karuār*, 13, 237.
 कवथारा *karuāra*, 13.
 कवथारी *karuāri*, 13, 237.
 कवद *karūi*, 44.
 कवद *karuchh*, 458.
 कवना *karuna*, 139.
 करू *karu*, 1045.
 करू तेल *karu tel*, 1045.
 करे *kare*, 1084, 1088.
 करेम *karem*, 1183.
 करै *karai*, 1088.
 करैल *karail*, 786, 808, 1067.
 करैला *karaila*, 1067.
 करैली *karaili*, 569, 1067.
 करैली कटग्ना *karaili katna*, 569.
 कल *kal*, 265, 330, 1023.
 कलकतिया *kalkatiya*, 1021.
 कलन्हा *kalchha*, 684.
 कलन्ही *kalchhi*, 684, 774.
 कलन्हुल *kalchhul*, 438, 458, 684.
 कलन्हुला *kalchhula*, 438, 564.
 कल जुग *kal jug*, 1023.
 कल जुग के अमृत *kal jug ke amrit*,
 1023.
 कलटग्री *kalatri*, 1207.
 कलनन्दरा *kalandara*, 1256.
 कलप *kalap*, 389.
 कलफ *kalaph*, 389.
 कलन्बुद *kalbud*, 565, 582.
 कलन्बून *kalbūt*, 484.
 कलन्बुद *kalbūd*, 484.
 कलम *kalam*, 422, 521, 541, 103:
 1039, 1052.
 कलन्मी *kalmi*, 370, 422, 1039, 107:
 कलन्मी साग *kalmi sāg*, 1073.
 कलन्मी सोरा *kalmi sora*, 370.
 कलन्रा *kalra*, 1395.
 कलन्वार *kalwār*, 371.
 कलन्सा *kalsa*, 713, 1307, 1308,
 1329, 1374.
 कलन्सी *kalsi*, 693, 713.
 कला *kala*, 585f.
 कलाद *kalāi*, 996.
 कलाग्रल *kalāēl*, 957.
 कलाबून *kalābūt*, 582.
 कलाल *kalāl*, 371.
 कलाली *kalāli*, 371.
 कलावा *kalāwa*, 1381.
 कलिदार *kalidār*, 727.
 कलियान *kaliyān*, 1138.
 कली *kali*, 765, 977, 1037, 1267.
 कलुथा *kalua*, 1456.
 कलुथा बीर *kalua bir*, 1456.
 कलुह *kaluchh*, 438.
 कलुस *kalus*, 438.
 कल्ले *kaleu*, 1269.
 कलेवा *kalewa*, 1269.
 कलैगर *kalaigar*, 510.
 कलोर *kalor*, 1118.
 कलौ *kalau*, 1269, 1341.
 कलौचा *kaluaa*, 1269.

कवण्डल *kañwandal*, 715.
 कवर *kawar*, 1271.
 कवाह *kawāchh*, 1073.
 कँवारण्यु *kamwārthu*, 1460.
 कसङ्कुट *kaskut*, 666, 689.
 कसङ्कौल *kaskaul*, 715.
 कसन्तरा *kastara*, 713.
 कसन्तरी *kastari*, 678, 713.
 कसन *kasani*, 507, 249.
 कसनि *kasani*, 744.
 कसमिरा *kasmira*, 1047.
 कसर *kasar*, 900.
 कसन्दा *kasla*, 525.
 कँसन्दा *kansla*, 525.
 कसन्दा *kaswa*, 1458.
 कसाद् *kasāi*, 1141.
 कसार *kasār*, 713, 1272, 1342.
 कसारा *kasāra*, 1342.
 कसावट *kasāvat*, 249.
 कँसासुरी *kansāsuri*, 1101.
 कंसुला *kansula*, 525.
 कसेरा *kasera*, 469, 556, 548.
 कसैया *kasaiya*, 1142.
 कसैली *kasaili*, 1056.
 कसौजी *kasauji*, 372.
 कसौटी *kasauti*, 537, 1113, 1134.
 कँसौठी *kansauthi*, 768.
 कह *kah*, 655, 1087.
 कहन्तरी *kahtari*, 139.
 कहन्तारी *kahtāri*, 1084.
 कहलगँव *kahalgāw*, 1486.
 कहवँ *kahwān*, 1275.
 कहहँ *kahahān*, 1085.
 कहहँ *kahān*, 478.
 कहवँ *kahāwai*, 763.
 कहि *kahi*, 1084.
 कहई *kahuā*, 1256.
 कहे *kahe*, 1088.
 कहँ *kahēn*, 1091, 1092.
 कहै *kahai*, 1084.

का *ka*, 414, 1088, 1092, 1367.
 काउन *kāun*, 988.
 काँ *kān*, 146.
 काण्य *kānth*, 1217.
 काक *kāk*, 1398.
 काक बन्धा *kāk banjha*, 1398.
 काँकर *kānkar*, 335e.
 काँकरि *kānkari*, 1070.
 काकुट *kākut*, 86.
 काँकुट *kānkut*, 86.
 काँखी *kānkhi*, 1024.
 काग *kāg*, 1398.
 कागज *kāgaj*, 404.
 कागञ्जी *kāgji*, 586.
 काग दुषस *kāg durus*, 1398.
 कागा *kāga*, 1088.
 कागी *kāgi*, 1043.
 काँव *kānch*, 1017, 1263.
 काँच रूआ *kānch rūa*, 1017.
 काँचा *kāncha*, 1235.
 काँची *kānchi*, 313, 1272.
 काँची चौनी *kānchi chāni*, 313.
 काह *kāchh*, 233, 790, 1113, 1134.
 काहक पाटी *kāchhak pāti*, 233.
 काहब *kāchhab*, 1030.
 काहा *kāchha*, 726, 743.
 काज *kāj*, 748.
 काजर *kājar*, 747, 1404.
 काट *kāt*, 1452.
 काटव *kātal*, 873, 1024.
 काटवँ *kātbon*, 356.
 काँटा *kāntā*, 104, 640, 748, 935.
 काँटा फोड़ी बखिया *kānta phori bakhya*, 748.
 काँटी *kānti*, 179.
 काटै *kātai*, 356.
 काठी *kāthi*, 1131, 1420.
 काँड़ *kānr*, 889, 890, 986.
 काड़ा *kāra*, 1120.
 काँड़ा *kānra*, 815, 889, 890, 936.

- काँड़ी *kānri*, 137, 612, 1168.
 काड़ी *kāri*, 1120.
 काढ़ *kārḥ*, 8, 279.
 काढ़ब *kārhab*, 1422, 1478.
 काड़ा *kārha*, 261, 279.
 काढ़ि *kārhi*, 1478.
 कात *kāt*, 550.
 कातर *kātar*, 272, 278.
 कातरि *kātari*, 272, 278.
 कातिक *kātik*, 1039, 1082, 1083, 1087.
 काँदू *kāndu*, 433.
 काँदून *kāndūn*, 433.
 कादो *kādo*, 423, 1084.
 कादो *kādo*, 789, 824, 931, 1086.
 कादो करब *kādo karab*, 981.
 काँधी *kāndhi*, 261.
 कान *kān*, 274, 933, 1420.
 कान काठी उत्तरब *kān kāthi utārab*, 1420.
 कानन्दार *kāndār*, 725.
 कानन्दार टोपी *kāndār topi*, 725.
 काननोत्सर्ग *kananotsarg*, 1459.
 कानर *kānar*, 952.
 काना *kāna*, 29, 933, 1011, 1075, 1183.
 कानी *kāni*, 41, 933, 940.
 काँनी *kānni*, 1006.
 कानू *kānu*, 293, 303, 433.
 कानो *kāno*, 789, 1011.
 कानो किच्चड़ *kāno kiechhar*, 789.
 कान्ह *kānh*, 256, 274.
 कान्ही *kānhi*, 1006.
 कान्ही के हर *kānhi ke har*, 1006.
 कान्हे *kānhe*, 478.
 काँप *kāmp*, 764.
 काफा *kāpha*, 1032.
 काबा *kāba*, 729.
 काबिस *kābis*, 786.
 काम *kām*, 999 (footnote).
 कामन्धेनुषा *kāmdhenua*, 1164.
 कामिनी *kāmini*, 1091.
 कामी *kāmi*, 531, 560.
 काथथ *kayath*, 999 (footnote).
 कारन्चोब *kārchob*, 502.
 कारन्चोबी *kārchobi*, 502.
 कारन्चोबी वाला *kārchobi wāla*, 502
 कारज *kāraj*, 1426.
 कारन्परन्दाल *kārpardāj*, 1208.
 कारन्बार *kārbār*, 1461.
 कारा बोगन्हा *kāra bogha*, 968.
 कारिख *kārikh*, 69, 747.
 कारी *kāri*, 786, 977, 996, 1137.
 कारी बाँक *kāri bānk*, 977.
 कारी माटौ *kāri māti*, 786.
 कारू दास *kāru dās*, 1456.
 कारू बीर *kāru bīr*, 1456.
 कारे *kāre*, 1089.
 कारोबार *kārohār*, 1461.
 कारोबारी *kārohāri*, 1461.
 कालन्बून *kālbūt*, 565.
 कालन्बूद *kālbūd*, 484.
 काला *kālu*, 965a, 996, 1023, 1043
 काला गीर *kālu gīr*, 965a.
 कालिब *kālib*, 475.
 काली *kāli*, 1455.
 काली अस्थान *kāli asthān*, 1455.
 कालीन *kālin*, 750.
 काशन्त *kāshnt*, 911.
 कास *kās*, 1075, 1091, 1151.
 काँस *kāns*, 1138.
 कास चरार *kās charāi*, 1151.
 कासन्नी *kānsni*, 1073.
 काँसन्ला *kānsula*, 525.
 कासा *kāsa*, 1342.
 काँसा *kānsa*, 558, 682, 1342.
 काँसी *kānsi*, 1075, 1091.
 काँसीवाल *kānsiwāl*, 725.
 काँसुला *kānsula*, 525.
 कास्त *kāst*, 1218.

- कालकार *kāstkār*, 1215.
 काह *kāh*, 1151 ; Appendix, 14.
 काह चराह *kāh charāi*, 1151 ;
 Appendix, 14.
 काहि *kāhi*, 1043.
 काहि सबुजा *kāhi sabuja*, 1043.
 काही *kāhī*, 366, 1235.
 काही पोस *kāhi pos*, 1235.
 काहू *kāhu*, 1073.
 कि *ki*, 1088.
 किंकिनी *kinkini*, 771.
 किच्चड़ *kichchar*, 789.
 किछु *kichhu*, 393, 1085, 1217.
 किता *kita*, 832, 1254, 1370.
 किता पारन्चा *kita pārcha*, 1370.
 किता *kitta*, 832.
 किनिहत *kinihā*, 1113.
 किमाम *kimām*, 1033.
 किथारा *kiyāra*, 832.
 किथारी *kiyāri*, 832.
 किथारी *kiyāri*, 62.
 किथाली *kiyāli*, 1201.
 किथौरी *kiyāuri*, 662.
 किराँची *kirāñchi*, 148.
 किराया *kirāya*, 1201.
 किरिन चकर *kirin chakkar*, 585.
 किरिया *kiriyā*, 1428, 1451.
 किरिया करम *kiriyā karm*, 1428.
 किरौना *kirāna*, 1074.
 किर्तिक *kirtlik*, 1084.
 किलखाना *kilkhāna*, 1140.
 किला *kila*, 585.
 किला *killa*, 431, 443, 464, 573, 621,
 932.
 किल्ली *killi*, 179, 331, 929, 936,
 1250.
 किशन अरपन *kishan arpan*, 1209a.
 किशुन अरपन *kishun arpan*,
 1209a.
 किशबत *kisbat*, 383, 388, 734.
 किशबद्द *kisbad*, 383.
 किशमन *kismat*, 383, 734.
 किशन्ली के रोटी *kisti ke roti*,
 272.
 कियान *kisān*, 834, 967, 1085, 1086,
 1088, 1091.
 कियुन पख (or पच्छ) *kisun pakh (or*
pachchh), 1081.
 किल *kist*, 1214, 1479.
 किल बन्दी *kist bandi*, 1479.
 किला *kista*, 715.
 की *ki*, 664 (note), 1088, 1183.
 कीच *kīch*, 789.
 कीरचन *kīchān*, 1458.
 कीनह *kinah*, 1087.
 कीथा *kīya*, 662.
 कीये *kīye*, 1091.
 कीरी *kiri*, 1074.
 कीरो *kīro*, 1074.
 कील *kil*, 164, 443, 621.
 कीला *kila*, 573.
 कुचार *kuār*, 1082.
 कुदयाँ *kuiyān*, 920b, 1459.
 कुदयाँ दान *kuiyān dān*, 1459.
 कुकरी *kukri*, 353.
 कुकुराँघा *kukraundha*, 1183.
 कुकाठ *kukāth*, 286.
 कुकड़ी *kukurhi*, 353, 1074.
 कुकुसा *kukusa*, 1183.
 कुकुची *kukuchi*, 1074.
 कुचबन्धवा *kuuchbandhwa*, 599.
 कुच्चा *kuucha*, 55.
 कुच्ची *kuuchi*, 536.
 कुँजड़ा *kuñjra*, 1456.
 कुजात *kujāt*, 1452.
 कुजात करब *kujāt karab*,
 1452.
 कुजात्रा *kujātra*, 1451.
 कुच्ची *kuuchi*, 55.
 कुच्ची *kuuji*, 1250.
 कुटका *kutka*, 325, 417, 896.
 कुटर्री *kuṭri*, 1144.

- कुटाप्रब *kutāḥ*, 624.
 कुटाँव *kutāw*, 892.
 कुटिया *kutiya*, 1144.
 कुट्टी *kutti*, 1144, 1234.
 कुठाँव *kuthāw*, 747.
 कुडँडिया *kudauriya*, 277.
 कुडण्डी *kudandi*, 33.
 कुडँदहना *kurdahina*, 831, 889.
 कुँडगुन्दन *kuṛmūdan*, 1434.
 कुँडगुन्नन *kuṛmūnan*, 1434.
 कुँडिया चास *kuṛiya chās*, 801.
 कुँडियाठी *kuṛiyāthi*, 929.
 कुहिया *kuṛhiya*, 713.
 कुण्ड *kund*, 268.
 कुण्डल *kundal*, 753.
 कुण्डली *kundli*, 1343.
 कुडा *kunda*, 143, 284, 368, 437,
 505, 713, 1349.
 कुण्डी *kundi*, 929.
 कुतुरम *kuturum*, 1047.
 कुत्ता *kutta*, 711, 1084, 1087.
 कुत्ती *kutti*, 711.
 कुत्तो *kutto*; 655.
 कुदरुम *kudrum*, 1047.
 कुदर *kudār*, 27, 28, 328.
 कुदारि *kudāri*, 328.
 कुदारी *kudāri*, 28, 369, 1048.
 कुदाल *kudāl*, 28.
 कुदाली *kudāli*, 28.
 कुद्दी *kuddi*, 82, 1203.
 कुनरी *kuṇri*, 1073.
 कुन्ती *kunti*, 1272.
 कुन्ड *kund*, 469, 570, 557.
 कुन्दा *kunda*, 401, 1141.
 कुन्दी *kundi*, 391, 1141.
 कुपोत्सरग *kupotsary*, 1459.
 कुप्पा *kuppa*, 719, 720.
 कुप्पी *kuppi*, 719, 1160.
 कुप्पी के घू *kuppi ke ghū*, 1160.
 कुम्भी *kumhbi*, 856, 859.
 कुमरुठी *kumarhuti*, 786.
 कुमरुठी *kumrauti*, 786.
 कुम्भी *kumhbi*, 1125.
 कुम्भड़ *kumhar*, 1071.
 कुम्हरा *kumhra*, 572.
 कुम्हार *kumhār*, 572, 1209b.
 कुम्हस *kumhes*, 1080.
 कुम्हैन *kumhain*, 572.
 कुम्हैनि *kumhaini*, 572.
 कुम्हता *kumta*, 744.
 कुम्हताली *kumtāli*, 902.
 कुम्हथी *kumthi*, 999.
 कुम्हथौली *kumthauli*, 1219.
 कुम्हदन *kumdan*, 616.
 कुम्हमिन *kummin*, 1090.
 कुम्हाव *kumhāo*, 797.
 कुम्हन *kumhan*, 602.
 कुम्हूर *kumhūr*, 439.
 कुम्हैल *kumhail*, 646.
 कुल *kul*, 1432, 1456.
 कुलन्तारा *kumtāra*, 412.
 कुल देवोता *kul devota*, 1456.
 कुलम्फी *kulphi*, 398, 473, 585.
 कुलम्फीदार *kulphidār*, 473a.
 कुलम्हर *kumhar*, 798, 818.
 कुलहारी *kumhāri*, 395.
 कुल्लिया *kumliya*, 585, 725.
 कुल्ली *kumli*, 725.
 कुस *kus*, 1428.
 कुसगुन *kusagan*, 1454.
 कुसगुत्तर *kusputr*, 1428.
 कुसवटन्ना *kusavatna*, 1074.
 कुसही *kusahi*, 959, 1000.
 कुसही केराव *kusahi kerāo*, 959.
 कुसाहन *kusāh*, 1454.
 कुसियाना *kusiyāna*, 1074.
 कुसियार *kusiyār*, 1005.
 कुसिहार *kusihār*, 1005.
 कुसी *kusi*, 1088.
 कुसुम *kusum*, 1043.
 कुहसा *kumhassa*, 1080.
 कुम्हार *kumhār*, 572.

- कुहेस *kuhes*, 1080.
 कुहेसा *kuhesa*, 1080.
 कुआँ *kūān*, 916, 920*b*, and 920*c*,
 1092.
 कुँच *kūnch*, 362*a*, 599.
 कुँचा *kūncha*, 53, 55, 465.
 कुँची *kūnchi*, 54, 428, 465, 543,
 599.
 कुटब *kūtab*, 624.
 कुटल जाइब *kūtal jāib*, 624.
 कुटि देब *kūti deb*, 624.
 कुटी *kūti*, 1234.
 कुँड़ *kūnṛ*, 268, 505, 713, 929.
 कुँड़ा *kūra*, 848.
 कुँड़ा *kūnra*, 83, 143, 437, 713,
 1434.
 कुँड़ा कुरकुठ *kūra kurkut*, 848.
 कुँड़ी *kūnṛi*, 83, 308, 929.
 कुँड़ *kūnṛh*, 251.
 कुँहा *kūnha*, 879, 1234.
 कुन *kūn*, 913.
 कुँदे *kūde*, 128 (footnote).
 कुन *kūn*, 538.
 कुप *kūp*, 920*b*, 1091.
 कुप जग *kūp jag*, 1459.
 कुबड़ *kūbar*, 1260.
 कूर *kūr*, 849.
 कूरो *kūro*, 1495.
 कूभी *kūsi*, 1091.
 कूहा *kūha*, 1080.
 के *ke*, 312, 445, 463, 478, 585*f*, 724,
 748, 814, 990, 1006, 1008,
 1009, 1015, 1023, 1025, 1040,
 1045, 1057, 1073, 825, 829, 849,
 919, 1118, 1139, 1175, 1183,
 1207, 1208, 1235, 1272, 1275,
 1377, 1479.
 केसारी *keāri*, 62.
 केसाल *keāl*, 914.
 केसाली *keāli*, 914, 1201.
 केँउआँ *keūān*, 1074.
 केँओचा *keōcha*, 456.
 केँड़वारी *keṅvāri*, 814.
 केतरपारा *ketarpāra*, 292.
 केतार *ketār*, 1005.
 केतारा *ketāra*, 1005.
 केतारी *ketāri*, 292, 1005, 1006.
 केमाम *kemām*, 1033.
 केरवा *kerwa*, 959.
 केराइ *keṛāi*, 959, 960, 1000, 1089.
 केराव *keṛāv*, 959, 960, 1000.
 केरुआर *keruār*, 237.
 केरौनी *kerāuni*, 866, 867.
 केलौनी *kelāuni*, 866, 867.
 केवलगचा *kevalgha*, 956.
 केवाँइ *kevānchh*, 1073.
 केवाड़ *kevār*, 1249.
 केँवाँड़ *keṅvār*, 1249.
 केँवाड़ी *keṅvāri*, 1249.
 केँवाँड़ी *keṅvāṛi*, 1249.
 केवाल *keval*, 786.
 केवाली *kevāli*, 1005.
 केवाही *kevāhi*, 1005.
 केसरिया *kesariya*, 1043.
 केसौर *kesaur*, 1062.
 केऊनी *keṅni*, 882, 886.
 केऊनीदार कुलफ़ी *keṅnidār kulphi*,
 173.
 के *ke*, 414, 568, 964, 1002 (foot-
 note), 1073, 1085, 1087, 1089.
 केँ *ken*, 356, 393, 604, 657, 741,
 841, 886 (footnote), 964, 1090.
 केड़ा *keṛa*, 1204.
 केँड़ा *keṅra*, 425.
 केना *kena*, 1075, 1183, 1436.
 केना डेहरी *kena dehrī*, 1436.
 केपल *kehal*, 973.
 केर *ker*, 393.
 केण्डू *kelhu*, 250.
 केसर *kesar*, 975.

- केशी *kesi*, 984.
 कंचिया *kainchiya*, 73, 226.
 कौरियार *kairiyār*, 807.
 कालाप्रल *kailāṭl*, 957.
 कालिया *kailiya*, 1074.
 कै *kai*, 1087, 1113.
 काँच *kainch*, 322, 1256.
 काँची *kainchi*, 226, 383, 474, 499,
 512, 522, 539, 550, 588, 1256.
 कैटी *kaiti*, 1034.
 कैटी *kainti*, 1034.
 काँडा *kairua*, 425.
 कैत *kait*, 585*f*, 1073.
 कैता *kaita*, 1072, 1073.
 कैतवान *kaitvān*, 585*f*.
 कैतुक *kaituk*, 1456.
 कैतुक गोसाँई *kaituk gosāñī*, 1456.
 कैदक *kaidak*, 1466.
 कैया *kaiya*, 511, 551.
 कैल *kail*, 1134.
 कैला *kaila*, 1113, 1134.
 कैला गेल *kaila gel*, 957.
 कैली *kailin*, 1002 (footnote).
 कैसे *kaise*, 1026.
 कोदनी *koini*, 1045.
 कोदन्टा *koinda*, 1045.
 कोइया *koiya*, 1074.
 कोइरी *koiri*, 807.
 कोइला *koila*, 1440, 1456.
 कोइला माना *koila māta*, 1440, 1456.
 कोइली *koili*, 1074.
 कोइला *koila*, 347.
 कोकट्टी *kokti*, 329, 1016, 1019.
 कोकिला *kokila*, 468.
 कोचबन *kochban*, 770.
 कोचला *kochla*, 1073.
 कोचला के साग *kochla ke sāg*, 1073.
 कोचानी *kochani*, 1245.
 कोठगर *kolhvār*, 1400.
 कोठिए *kothie*, 1090.
 कोठिया *kothiya*, 1263.
 कोठिया ईंटा *kothiya inta*, 1263.
 कोठियारी *kothiyāri*, 1201.
 कोठियौ *kothiyau*, 890.
 कोठिला *kothila*, 924, 77.
 कोठिली *kothili*, 77, 85.
 कोइन्नी *korni*, 824, 865, 866, 867
 1009.
 कोड़ार *korār*, 808.
 कोइया *korhiya*, 1074.
 कोइला *korhila*, 1183.
 कोतवान *kotvāl*, 1200.
 कोथली *kothli*, 770.
 कोदई *kolāi*, 992.
 कोदार *kolār*, 27, 28, 369.
 कोदारि *kolāri*, 28.
 कोदारी *kolāri*, 28, 319*k*.
 कोभमिया *konasiya*, 828.
 कोनसी *konsi*, 828.
 कोनासी *konāsi*, 832.
 कोनिया *koniya*, 603, 828.
 कोनिया जोत *koniya jot*, 828.
 कोम्हड़ा *komhra*, 1071.
 कोरई *korāi*, 367, 1050.
 कोरझा *koranjha*, 844.
 कोरण्पोछुआ *korponchhua*, 1397.
 कोरन्मार *kornār*, 161.
 कोरवास *korvās*, 1051.
 कोरखत *korsāt*, 404.
 कोराइ *korāi*, 894.
 कोराँट *korānt*, 807.
 कोराना *korana*, 1185.
 कोरार *korār*, 784, 807.
 कोरियार *koriyār*, 807.
 कोरेना *korēna*, 372.
 कोरौनी *korāuni*, 1161.
 कोलंगटार *kolāra*, 412.
 कोलगाइ *kolwāi*, 832.
 कोलंगार *kolsār*, 297, 300.
 कोलसुप *kolsup*, 47, 603.

- कोलिऐती *koliatī*, 1219.
 कोलिऐती असामी *koliatī asāmi*, 1219.
 कोल्हकढ़ *kolhkarh*, 1194.
 कोल्हकर *kolhkar*, 1194.
 कोल्हपचरानौ *kolhpachrāni*, 1194.
 कोल्हुआ *kolhuā*, 1097.
 कोल्हुआ बैल *kolhuā bail*, 1097.
 कोल्हचार *kolhuār*, 297, 300.
 कोहंडुंगर *kohāngar*, 578.
 कोहंडा *koñhra*, 1071.
 कोहबर *kohbar*, 1307, 1308, 1335, 1358.
 कोहबरत *kohbara*, 1335.
 कोहन्तौरी *konhrauri*, 1272.
 कोहार *kohār*, 572.
 कोहिथा *kohiṭhā*, 713.
 को *ko*, 655.
 कोइन *kōin*, 1045.
 कोइल *koil*, 1076.
 कोइलखो *koilkho*, 1075.
 कोच *koṭch*, 1045.
 कोचा *koṭhā*, 741.
 कोची *koṭhī*, 726, 741.
 कोठा *koṭhā*, 1240.
 कोठी *koṭhī*, 77, 79, 310, 365, 814, 924, 1400; Appendix, 14.
 कोठीवाल *koṭhivāl*, 1461.
 कोठी सोरा *koṭhī sorā*, Appendix, 14.
 कोड़ *kor*, 867, 1009.
 कोड़ देब *kor deb*, 867.
 कोड़न *korān*, 824, 865, 866, 1006, 1099.
 कोड़पक्का *korṭpakkā*, 1182.
 कोड़ब *korāb*, 865, 981.
 कोड़ल *korāl*, 1009.
 कोड़ा *korā*, 104, 1007.
 कोड़ी *korī*, 834.
 कोड़ा *korhā*, 170, 414.
 कोड़ी *korhī*, 841, 886 (footnote), 1098.
 कोड़ि बरद कँ फेफरि बहल *korhī barad koñ phephari bahal*, 841.
 कोड़ी *korhī*, 379, 799.
 कोदर कट्टा *kodar katta*, 1456.
 कोदो *koḍo*, 990, 992, 1089.
 कोन *kon*, 128 (footnote), 604, 828.
 कोना *kona*, 828.
 कोना कोनी *kona konī*, 828.
 कोनी *konī*, 828.
 कोपिन *koṭin*, 726.
 कोपीन *koṭīn*, 726.
 कोबी *kobī*, 1073.
 कोर *kor*, 866, 1271.
 कोरन *korān*, 866.
 कोरा *korā*, 104, 788, 1258.
 कोरा बाल *korā bāl*, 788.
 कोरी *korī*, 1053, 1143.
 कोरी करब *korī karab*, 1143.
 कोरो *korō*, 367, 1050, 1051, 1258.
 कोल *kol*, 1456.
 कोला *kolā*, 832.
 कोली *kolī*, 832.
 कोल्ह *kolh*, 250, 265.
 कोल्हु *kolhū*, 250, 265.
 कोभ *kos*, 1492.
 कोसा *kosā*, 984.
 कोसी *kosī*, 959.
 कोसम *kosam*, 1043.
 कोहा *kohā*, 139, 430, 432, 442, 713.
 कहूँ *kohī*, 139, 140.
 कौआरा *kaurā*, 1183.
 कौरना *kaurna*, 138.
 कौरेना *kaurna*, 372.
 कौशल *koṭṣal*, 1256.
 कौआ *kaū*, 356, 792, 870, 957, 1398.
 कौआ भूपान *kaūa jhapān*, 957.
 कौआ बाँझ *kaūa bāñjh*, 1398.
 कौआ लुकान *kaūa lukān*, 957.

कौशा हाँकब *kaua hānkab*, 870.
 कौड़ *kaur*, 1247.
 कौड़ी *kauri*, 1201, 1391, 1496.
 कौनी *kauni*, 988, 1045.
 कौम *kaum*, 1125.
 कौर *kaur*, 1078, 1247, 1271.
 कौर जाग्रब *kaur jāēb*, 1078.

कौरी *kauri*, 1143, 1256.
 कौरी करब *kauri karab*, 1143.
 कौल्हा *kaulha*, 1247.
 क्या *kyā*, 1091.
 क्यौंचा *kyoncha*, 74.
 क्रित्तिका *krittika*, 1082, 1084.
 क्रिशन् *krishan*, 1456.

॥ खू *kh* ॥

खई *khāi*, 833.
 खखन्डी *khankhri*, 1074.
 खखन्बहुरा *khankhrahra*, 669.
 खखन्ग *khakhra*, 894, 901.
 खखो न्नी *khakhorni*, 37, 328.
 खखोड़ी *khankhori*, 1161.
 खखोरन *khakhoran*, 1032.
 खगडा *khagra*, 1183.
 खगन्रा *khagra*, 379.
 खगन्रा *khagra*, 379.
 खगन्री *khagri*, 379.
 खगन्रीवा *khagrīva*, 1021.
 खंगाहा *khangaḥa*, 1172.
 खगूर *khagūr*, 226.
 खंचडा *kanchra*, 789.
 खंचिजा *khanchiya*, 43, 44.
 खचोली *khacholi*, 44.
 खचुड़ *khachchar*, 1128.
 खजला *khajla*, 1272.
 खजन्वा *khajwa*, 1263.
 खजाना *khajāna*, 188, 321, 916, 919,
 952, 1207.
 खजूर *khajūr*, 585f, 1272.
 खझा *khajā*, 1174.
 खटाई *khatāi*, 1003, 1272.
 खटिया *khatiya*, 636, 1416.
 खटुला *khatula*, 636.
 खटोला *khatola*, 636, 1457.
 खटोली *khatoli*, 636.
 खट्टा *khatta*, 1272.

खड्डा *khaddha*, 34.
 खड्डी *khaddhi*, 20.
 खड़ *khār*, 1234.
 खंडू *khaur*, 832, 865.
 खड़कडा *kharkatta*, 915.
 खंडुगरन्ना *khaurgarana*, 314.
 खड़न्चर *khurchar*, 277.
 खंडन्चर *khurchar*, 259, 277.
 खंडन्चारी *khurchāri*, 259.
 खड़न्मा *khurma*, 319k.
 खड़न्मोड़ा *khaurmora*, 915.
 खड़न्वाहा *khaurwāha*, 915.
 खड़न्वाहा *khaurwāha*, 915, 915.
 खंडन्चर *khaurhar*, 1234.
 खड़न्हा *kharcha*, 8.
 खंडन्हु *khaurhu*, 919.
 खंडन्मार *khaurśār*, 312.
 खंडन्मारी *khaurśāri*, 312.
 खड़ाउन *kharaūn*, 735.
 खड़ाउण *kharaūn*, 735.
 खड़ा टाल *khara tāl*, 890.
 खंडार *khaurār*, 578.
 खड़ौव *kharaūv*, 735.
 खंडुआर *khauruār*, 945.
 खड़ुका *kharuka*, 1075.
 खंडौरा *khaurāwa*, 1272.
 खड़ौर *kharhaur*, 815.
 खड़ौल *kharhaul*, 815.
 खण्ड *khand*, 832.
 खतन्कस *khatkas*, 404.

- खमना *khana*, 386, 1415.
 खतियौनी *khatiyauni*, 1463d.
 खत्ता *khutta*, 77, 833.
 खदगौर *khadgaur*, 850.
 खदन्हा *khadha*, 34.
 खदियाञ्चोल *khadiyañöl*, 1006.
 खदुका *khaduka*, 1461, 1477, 1481.
 खदोना *khadona*, 721.
 खदौड़ *khadaur*, 848, 850.
 खदौड़ खेत *khadaur khet*, 850.
 खदौर *khadaur*, 850.
 खदुक *khadduk*, 1461, 1477, 1481.
 खड्डी *khaddhi*, 848.
 खधा *khadha*, 77.
 खधेल *khadhel*, 1145.
 खधौट *khadhaut*, 832.
 खन *khan*, 1194.
 खनजौर *khanjār*, 924.
 खनन *khanan*, 165.
 खनसारी *khansāri*, 646.
 खनचन *khanhan*, 165.
 खनित *kh-nit*, 1493.
 खन्ता *khanta*, 833, 1493.
 खन्ती *khanti*, 39, 40.
 खन्ध *khandh*, 832.
 खन्धा *khandha*, 832.
 खपण्डा *khapa*, 319, 437, 713, 924, 1262, 1399.
 खपण्डौ *khapri*, 319, 437, 713.
 खपण्डौइया *khaproīya*, 1074.
 खपरा *khapra*, 924, 1246.
 खपरा फेरब *khapra pherab*, 1246.
 खपरी *khapri*, 713, 1422.
 खपरोइया *khaproīya*, 1074.
 खपराउरी *khaprauri*, 713, 1401.
 खपरावर *khaprawar*, 1401.
 खपरावर फेंकाद *khaprawar phenkāc*, 1401.
 खपियार *khapiyār*, 646.
 खबीरा *khambīra*, 468.
 खबौनी *khabauni*, 1272.
 खभार *khabhār*, 921, 1125.
 खंबिया *khambhiya*, 765.
 खमन्गो *khamsō*, 392.
 खमीरा *khāmīra*, 468, 1021, 1023.
 खम्भा *khambha*, 414, 431, 609, 933, 940, 1051, 1256.
 खम्भिया *Khumbhiya*, 1256.
 खम्भी *khambhī*, 1256.
 खम्बरुआ *Khambara*, 1458.
 खम्हा *khambha*, 473, 940.
 खम्हाँ *khambhāñ*, 1256.
 खम्हार *khambhār*, 890, 986.
 खम्भिया *khambhiya*, 1256.
 खर *khār*, 367, 539, 815, 1010.
 खरई *kharaī*, 815, 896, 1052.
 खरकूटी *Kharkūti*, 363.
 खरको खूटा *kharko khūta*, 363.
 खरकोटी *kharkoti*, 1253.
 खरकोट *kharkaut*, 363.
 खरकौडी *kharkauti*, 363.
 खरःखण्डा *Kharkhanda*, 669.
 खरःखरिया *kharkhāriya*, 248.
 खरगोम *khargos*, 740.
 खरग्न *kharch*, 1207, 1463d.
 खरःचराद *kharcharā*, 1151.
 खरन्वरी *kharcharī*, 1151.
 खरन्चा *kharcha*, 1052, 1207.
 खरन्चाक *kharchāk*, 1084.
 खरन्चांडी *kharchāñri*, 277.
 खरन्चारी *kharchārō*, 277.
 खरन्चाली *kharchālī*, 259, 277.
 खरःशूआ *kharchhū*, 1075.
 खरःपा *kharpa*, 735.
 खरःवडाद *kharchatāi*, 913.
 खरःबूजा *kharchūja*, 1065.
 खरन्वन *kharchan*, 1204.
 खरन्वा *kharcha*, 816.
 खरन्वाह *kharchāh*, 858.
 खरन्वाहा *kharchāha*, 915, 915.

खरन्वे *kharve*, 549, 858.
 खरन्वेच *kharvech*, 858
 खरन्सान *kharśān*, 539, 1024.
 खरन्हार बावग *kharhar bāwag*, 858.
 खरन्हरा *kharhara*, 55, 57, 465.
 खरन्हरो *kharharo*, 57.
 खरन्हिया *kharhiya*, 125.
 खरन्ही *kharhi*, 1051.
 खरन्हर *kharahur*, 815.
 खराञ्चोनि *kharāñi*, 735.
 खराट *kharāt*, 549.
 खराट् *kharāt*, 406, 469, 557.
 खरादी *kharādi*, 406.
 खराम *kharām*, 735.
 खरिका *kharika*, 1310.
 खरिकौता *kharikauta*, 1253.
 खरित *kharit*, 850.
 खरिदंगी *kharidgi*, 1209d, 1215.
 खरिदार *kharidār*, 1214.
 खरिहान *kharihan*, 1188.
 खरिहान *kharihān*, 879, 1090.
 खरिहानी *kharihāni*, 879, 914, 1191,
 1196, 1197, 1200.
 खरी *khari*, 250, 480, 1424.
 खरोट् *kharūt*, 1040.
 खरुचा *kharua*, 467.
 खरुका *kharuka*, 740, 1074.
 खरुकी *kharuki*, 740.
 खरुहान *kharuhan*, 864.
 खरुहान *kharuhān*, 982.
 खरुहो *kharuho*, 1124.
 खरुया *kharaiya*, 125.
 खरुटा *kharaittha*, 815.
 खरुल *kharul*, 646.
 खरो घर *kharo ghar*, 1235.
 खर्रा *kharra*, 55, 57, 1182.
 खर्री *kharrī*, 263.
 खलन्कोदया *khalkoiya*, 990.
 खलन्ची *khālchi*, 713.
 खलन्चोदया *khālchoiya*, 981

खलन्डू *khalri*, 1139.
 खलन्तेदार *khalledār*, 727.
 खलन्नी *khalni*, 520.
 खलन्वा *khalwa*, 790.
 खलार *khalār*, 790.
 खलितडू *khalitari*, 1119.
 खलिहानि *khalihāni*, 912.
 खल्लो *khalli*, 263.
 खल्लर *khallar*, 790.
 खवास *khawās*, 1184.
 खसखस *khaskhas*, 362a.
 खसम *khagam*, 1274.
 खसन्रा *khavra*, 913, 1468 a and b,
 1470, 1471; Appendix, 8.
 खसन्रा दावाबन्दी *khavra dāwabandī*,
 1468a, 1470; Appendix, 1.
 खसन्रा बटाइ *khavra batāi*, 1468.
 खसन्रैया *khavraiya*, 362.
 खसन *khasal*, 1080.
 खसिया *khasiya*, 373, 768.
 खस्सी *khassi*, 1121.
 खस्सी *khāssi*, 1121.
 खाइक *khāik*, 1269.
 खाई *khāi*, 833.
 खाज *khāu*, 1477.
 खाए *khāc*, 1026.
 खाँखर *khānkhār*, 920c, 921.
 खाँग *khāng*, 1174.
 खाँगन *khāngan*, 165.
 खाँगल *khāngal*, 1174.
 खाँच *khānch*, 318.
 खाँचा *khāncha*, 44, 318, 319f, 459.
 खाँची *khānchi*, 44, 319f.
 खाजे खिदर *khaje khidar*, 1456.
 खाजा *khāja*, 1272.
 खाजाना *khājāna*, 916.
 खाँजी *khānji*, 648.
 खाँजी *khānjhi*, 44.
 खाट *khāt*, 636.
 खाटिन *khātin*, 966d.

खाँड़ *khāūr*, 919, 1014.
 खाँड़ी *khāūri*, 20, 740.
 खाँड़ो *khāūro*, 919.
 खाह *khārh*, 1082.
 खाही *khāhi*, 8, 20.
 खानत *khāta*, 20.
 खातब *khātab*, 1461, 1477.
 खाना *khāta*, 8, 77, 269, 315, 319,
 1462, 1463c, 1477.
 खाना बही *khāta bahi*, 1463c.
 खातिर *khātir*, 1192.
 खाद *khād*, 77, 849, 1008.
 खाँदन *khāndan*, 165.
 खादर *khādar*, 848, 849, 868.
 खाध *khādh*, 77.
 खाधा *khādha*, 77.
 खान *khān*, 251, 268, 1194.
 खानचा *khāncha*, 459, 467.
 खानदान *khāndan*, 1209c.
 खानन *khānan*, 165.
 खाना *khāna*, 394, 478, 1248, 1393.
 1398
 खानी *khāni*, 1272.
 खाने बाग *khāne bāg*, 813.
 खाप *khāp*, 402, 1221.
 खापड़ *khāpar*, 437.
 खापरि *khāpari*, 713.
 ख़ाब *khāb*, 399, 402.
 खाबड़ *khābar*, 792.
 खाबर *khābar*, 792.
 खाभर *khābhar*, 792.
 खाभल *khābhal*, 867.
 खाम *khām*, 1235.
 खामसो *khāmsō*, 392.
 खाना *khāma*, 431.
 खाम्ही *khāmhi*, 1051, 1256, 1259.
 खाय *khāy*, 250, 356, 1084, 1087,
 1113, 1269, 1272.
 खार *khār*, 1080.
 खारी *khāri*, 816.

खास *khāru*, 864, 982.
 खासख़ाँ *khāruān*, 1042.
 खाल *khāl*, 414, 790, 792, 1139.
 खावा *khāwa*, 713, 917.
 खाँवाँ *khāwān*, 833, 917, 953.
 खाविन्द *khāwind*, 1274.
 खास *khās*, 131; Appendix, 11.
 खासदान *khāsdān*, 711.
 खासर *khāsar*, 1164.
 खिखोरना *khikhorna*, 493.
 खिखोरनी *khikhorni*, 493.
 खिङ्गा *khinga*, 445.
 खिचख़ड़ी *khichkharī*, 963, 1272.
 खिचनी *khichni*, 145.
 खिच़ा *khichha*, 984.
 खिजाया *khijāya*, 963.
 खिधोरना *khidhorna*, 493.
 खिनौरी *khinauri*, 2, 825.
 खिनौरी के जोत *khinauri ke jot*, 825.
 खिथाव *khithāo*, 1338.
 खियौल *khiyaulā*, 1217.
 खिरकी *khirki*, 1249.
 खिरख़ियाद *khirkhigād*, 1407.
 खिरख़ियौनी *khirkhiyāuni*, 1338.
 खिरचटाइ *khirchatāi*, 1407.
 खिरन्ची *khirchi*, 402.
 खिरन्दन *khirdant*, 969.
 खिरवरा *khiravara*, 1002 (footnote),
 1272.
 खिरना *khirna*, 1164.
 खिरौरा *khiraura*, 1272.
 खिलकट *khilkat*, 797, 981.
 खिलकट्टी *khilkatti*, 797, 981.
 खिलनी *khilni*, 402.
 खिलबट्टी *khilbatti*, 711.
 खिलमार *khilmār*, 795, 797, 981.
 खिलगत *khilgat*, 1236.
 खिलख़ौ *khilhi*, 1192.
 खिलख़ोरना *khilkhorna*, 493.
 खिलुआ *khilua*, 740.

- खिलोरन्ना *khilorna*, 493.
 खिलत *khillat*, 1209b.
 खिळा *khilla*, 24.
 खिळी *khilli*, 711, 1055.
 खिसकट *khiskat*, 727.
 खीकी *khikhi*, 713.
 खींचव *khinchav*, 391.
 खींची *khinchi*, 1079.
 खीर *khīr*, 1272, 1338, 1389, 1405.
 खीर खियाव *khīr khīyāv*, 1338.
 खीरा *khīra*, 533, 1070.
 खीरा बिची *khīra bīchī*, 533.
 खीरि *khīri*, 1272.
 खील *khīl*, 795, 797, 981.
 खील कोडव *khīl korab*, 981.
 खील तोडव *khīl torab*, 981.
 खील बैठाखोल *khīl baithāol*, 795.
 खील मारी *khīl māri*, 1192.
 खुक्खा *khukkha*, 1076.
 खुक्खासा *khukhsa*, 1183.
 खुखुडी *khukhuri*, 984.
 खुटरा *khutra*, 182, 244.
 खुंटरी *khutri*, 182, 185, 200.
 खुटन्ला *khutla*, 764.
 खुटन्ली *khutli*, 764.
 खुटहरा *khutahra*, 2.
 खुटहरी *khutahri*, 182.
 खुंटानान *khuntānān*, 224.
 खुंटिपुत्ति *khuntiputti*, 348.
 खुटिया *khutiya*, 728.
 खुंटिया *khuntiya*, 1008, 1010, 1024.
 खुटिया अंगरखा *khutiya angarkha*,
 728.
 खुटिळा *khutika*, 764.
 खुंटिहरी *khuntihri*, 182.
 खुटहरा *khutahra*, 825.
 खुटहरी *khutahri*, 182.
 खुटा *khutta*, 363, 431, 609.
 खुट्टा *khutli*, 489, 573, 764.
 खुटा *khuta*, 40, 213, 461, 609.
 खुटा *khunda*, 361.
 खुण्डो *khundi*, 361.
 खुद *khud*, 911.
 खुदन्काशत *khudkāsht*, 911.
 खुदन्नी *khudni*, 27.
 खुदर *khudar*, 1048.
 खुद्दी *khuddi*, 1272.
 खुबिया *khubiya*, 764.
 खुम *khum*, 83.
 खुरका *khurka*, 1075.
 खुरखुन *khurkhun*, 1079.
 खुरचन *khurchan*, 1032.
 खुरचनी *khurchani*, 319b, 456, 1
 खुरचनी *khurchani*, 453.
 खुरचुनी *khurchuni*, 424, 512.
 खुरजी *khurji*, 129.
 खुरदाई *khurdāi*, 888.
 खुरदिद्या *khurdiya*, 1208.
 खुरदिद्या मालिक *khurdiya mālik*.
 खुरदिहा *khurdiha*, 1208, 1211
 खुरदिहा मालिक *khurdiha mā*
 1208.
 खुरदोंती *khurdonti*, 888.
 खुरदौनी *khurdāni*, 888.
 खुरनी *khurni*, 27.
 खुरपा *khurpa*, 59, 60, 306, 369.
 खुरपियाना *khurpiyāna*, 866, 867
 खुरपी *khurpi*, 61, 306, 328, 4
 481, 486, 867.
 खुरफा *khurpha*, 1073.
 खुरमा *khurma*, 1272.
 खुरहा *khurha*, 1172.
 खुरा *khura*, 90.
 खुरी *khuri*, 90.
 खुश *khush*, 1040.
 खुशका *khushka*, 1272.
 खुशकी ठीका *khushki thika*, 1210.
 खुश खरीद *khush kharid*, 1010.
 खुशकी *khuski*, 788, 1040, 1272.
 खुशबकत *khushbakat*, 1209d.

- खुसबरी *khusbari*, 1073.
 खुआ *khāa*, 888, 891.
 खुंट *khünt*, 726, 1141.
 खुंटा *khānta*, 213, 223, 224, 239,
 330, 363, 414, 431, 464, 469,
 489, 538, 609, 932, 1142, 1419.
 खुंटा बन्ना *khānta balla*, 319j.
 खुंटी *khānti*, 32, 258, 260, 330,
 348, 401, 489, 573, 595, 621,
 932, 1008, 1010, 1039, 1194.
 खुंड़ा *khūra*, 361.
 खुंड़ी *khūri*, 361.
 खुम *khūm*, 713.
 खुर *khūr*, 383.
 खुरा *khūra*, 13, 78.
 खखसा *khukhsa*, 1073.
 खंधड़ा *khendhra*, 637.
 खंधरा *khendhra*, 731.
 खनरा *khēra*, 637.
 खपान *khopān*, 289.
 खरका *kheraka*, 740.
 खरकी *kheraki*, 740.
 खेलाइ *khelāi*, 1198.
 खेसरा *khesra*, 959.
 खेमारी *khesāri*, 959, 999, 999n.
 खेदा *kherha*, 8, 965.
 खेही *Fherhi*, 820, 1404.
 खेही *kherhi*, 8.
 खेही जोड़ाब *kherhi jorāb*, 1404.
 खेत *khet*, 69, 356, 797, 798, 827,
 832, 834, 850, 981, 1006, 1090,
 1120, 1435.
 खेत पथार *khet pathār*, 832.
 खेत बधार *khet badhār*, 832.
 खेत भोजनी *khet bhajni*, 1435.
 खेत भोज *khet bhaj*, 1435.
 खेत मास *khet mās*, 999.
 खेत मासु *khet māsu*, 999.
 खेती *kheti*, 832, 1456.
 खेती बारी *kheti bāri*, 832.
 खेती भवानौ *kheti bhawāni*, 1456.
 खेना *khēna*, 76.
 खेप *khēp*, 646.
 खेवा *khēwa*, 235 (footnote).
 खेचा *khēcha*, 8.
 खेचा *khāincha*, 44.
 खेची *khāinchi*, 288.
 खेनी *khāini*, 1023, 1026.
 खेया *khāiya*, 1269.
 खेर *khair*, 1073.
 खेरा *khaira*, 1074.
 खेरत *khairat*, 1209d, 1431.
 खेरी *khari*, 1074.
 खेचन *khāchan*, 844, 1188.
 खोँचा *khoucha*, 984.
 खोँका *khoincha*, 741, 941.
 खोदया *khōiya*, 290, 984, 1012, 1031.
 खोदचा *khōiha*, 290.
 खोपका *khoechha*, 741.
 खोखरी *khonkhri*, 984.
 खोमन्हा *khomgha*, 1172.
 खोचरी *khonchri*, 77.
 खोजड़ा *khojra*, 1076.
 खोटगला *khotta*, 764.
 खोटगली *khottli*, 241.
 खोड़ना *khorna*, 441.
 खोड़नी *khorni*, 441.
 खोदाइ *khodāi*, 1431.
 खोदौना *khodauna*, 303.
 खोनचा *khoncha*, 459, 467.
 खोंपड़ा *khomptra*, 879, 1234.
 खोंपड़ी *khompri*, 71, 879, 1234.
 खोबार *khēbār*, 1125.
 खोभना *khobhna*, 40.
 खोभार *khobhār*, 1125.
 खोभारि *khobhari*, 1125.
 खोभिया *khobhiya*, 1272.
 खोरना *khornā*, 303, 441, 705.
 खोरनाठी *khornāthi*, 441.
 खोरनी *khorni*, 303, 441, 705.

खोरन्मा *khorma*, 1272.
 खोरन्हा *khorha*, 1172.
 खोराकी *khorāki*, 1209e.
 खोरासानी *kkorāsāni*, 1073.
 खोरासानी जवाइन *khorasāni jawāin*,
 1073.
 खोरिया *khoriya*, 511.
 खोलकन्डा *kholakrā*, 582.
 खोलन्ही *khohri*, 990, 1031.
 खोलन्नी *kholni*, 520, 582.
 खोलनैया *kholnaiya*, 232.
 खोलनरिया *kholmariya*, 523.
 खोलन्सा *kholsa*, 97, 261.
 खोहिया *khohiya*, 290, 1012, 1031.
 खोष्ठा *khoā*, 888, 891, 1167.
 खोइया *khoiya*, 1272.
 खौइह *khōūchh*, 621.
 खोखा *khokha*, 1487.
 खोगीर *khogīr*, 226.
 खौच *khonch*, 269
 खौची *khonchi*, 41.
 खौहा *khonchha*, 741.
 खोज *khuj*, 1286.

खोइ *khoh*, 1141.
 खौही *khonri*, 361.
 खौहा *khonrha*, 8.
 खोइह *khodab*, 1379.
 खोना *khona*, 721.
 खोन्ही *khonhi*, 1248.
 खौप *khomp*, 50, 79, 895, 1234.
 खौप के मथनी *khomp ke mathni*, 895.
 खौपी *khompi*, 895.
 खोभन *khobhan*, 40.
 खोभी *khobhi*, 1183.
 खोम *khom*, 1125.
 खोर *khoh*, 143, 284, 368, 713, 893,
 1461.
 खोरा *khora*, 83, 284, 308, 690, 713.
 खोरिश *khorish*, 1209c.
 खोरी *khori*, 680.
 खोल *khoh*, 22, 97, 156, 730, 933.
 खोला *khola*, 97, 261.
 खोली *khohi*, 223, 22.
 खोच *khoh*, 891.
 खौक *khauk*, 1461.
 खौकार *khaukār*, 1477.

॥ ग g ॥

गग *gae*, 1084.
 गंगटा *gangta*, 794.
 गंगटाहा *gangtāha*, 794.
 गंगटियाहा *gangtiyāha*, 794.
 गंगटी *gangti*, 794.
 गगन्टा *gagra*, 693, 711.
 गगरी *gagri*, 304, 432, 713, 786.
 गगरी केवाल *gagri kewāl*, 786.
 गङ्ग *gang*, 788.
 गङ्गट *gangat*, 794, 1266.
 गङ्ग बरार *gang barār*, 788.
 गङ्ग सिकस *gang sikast*, 788.
 गङ्गा *ganga*, 1451, 1456.
 गङ्गाक *gangāk*, 1451.

गङ्गा जल *ganga jal*, 1451.
 गङ्गा मार *ganga māi*, 1456.
 गच *gach*, 423.
 गकुली *gachhuli*, 814.
 गज *gaj*, 154, 471, 474, 477, 582,
 711, 1490, 1491, 1492.
 गजन्डा *gajra*, 1073.
 गजन्पती *gajpati*, 977.
 गजन्पत्ता *gajpatta*, 975.
 गजन्बाक *gajbāk*, 102.
 गजन्बाग *gajbāg*, 102, 224.
 गजर *gajar*, 826, 959.
 गजर बजर *gajar bajar*, 959.
 गजर मसर *gajar masar*, 959.

गजन्तरा *gajra*, 1073.
 गजन्तरौटा *gajrauta*, 1144.
 गजन्तरौटी *gajrauti*, 1144.
 गजन्वाह *gajwāh*, 646.
 गजन्ही *gajhi*, 144.
 गजा *gaja*, 959.
 गजाँड़ *gajāñr*, 798.
 गजाड़ा *gajāra*, 40.
 गजा बजा *gaja baja*, 959.
 गँजिया *ganjiya*, 227.
 गजुर *gajur*, 1001.
 गञ्ज *ganj*, 224, 585.
 गञ्ज अफजुद *ganj aphiūd*, Appendix, 2a.
 गञ्ज सितार *ganj sitāra*, 585.
 गट्टा *gatta*, 472, 1272.
 गट्टी *gatti*, 498.
 गँठौट *ganthaut*, 1480.
 गठौरा *gathaura*, 770.
 गँड़कसा *ganrkassa*, 236.
 गड़किल्ली *garckilli*, 258.
 गड़गाड़ा *gargara*, 473.
 गड़नी *garni*, 365, 919, 1183.
 गँड़मेखा *ganrmekha*, 932.
 गँड़रकटा *ganrkattu*, 915.
 गड़रा *garra*, 1074.
 गँड़सार *ganrsār*, 1008.
 गँड़सी *ganrsi*, 86.
 गड़न्चड़ो *garharo*, 106.
 गड़न्हर *garhar*, 1075.
 गँड़न्हर *ganrhar*, 1183.
 गड़न्हखा *garharua*, 1183.
 गड़न्हा *garha*, 849.
 गँड़न्ही *gandhi*, 1479.
 गड़ाड़ी *garāri*, 595.
 गड़ार *garār*, 1074, 1075, 1183.
 गड़ारी *garāri*, 940.
 गँड़ारी *ganrāri*, 62, 832, 833.
 गँड़ास *ganrās*, 86.
 गड़ाँस *garāns*, 86.

गँड़ासा *ganrāsa*, 86.
 गड़ाँसा *garānsa*, 86.
 गँड़ासी *ganrāsi*, 86, 88.
 गड़ियार *gariyār*, 1183.
 गड़ियास *gariyās*, 408.
 गड़ी *gari*, 147.
 गँड़खा *ganrua*, 924.
 गड़ेड़ी *gareri*, 488.
 गँड़ेर *ganrer*, 1183.
 गँड़ेरी *garēri*, 1150.
 गँड़ेरी *ganrerē*, 1183.
 गड़ौआ *garauān*, 924.
 गड़ौकी *garaukhi*, 1183.
 गड़न्रो *garhro*, 1075.
 गड़ाह *garhāi*, 537.
 गड़ *garhen*, 568.
 गण्डा *ganda*, 823, 854, 1498.
 गण्डा डार *ganda dhār*, 1007.
 गतान *gatān*, 120, 122, 639.
 गतार *gatār*, 938.
 गताल *gatāl*, 1477.
 गताल खांता *gatāl khāta*, 1477.
 गतौरा *gataura*, 120.
 गत्ती *gatti*, 713.
 गत्तो *gatto*, 614, 621.
 गदपँड़ोखा *gadpunroa*, 1183.
 गदपिड़ोखा *gadpirova*, 1183.
 गदपुरना *gadpurna*, 1183.
 गदरा *gadra*, 877.
 गदन्राख *gadräëb*, 1004.
 गदन्राखल *gadräël*, 957, 1001.
 गदन्राखल है *gadräël hai*, 957.
 गदन्हा *gadha*, 105 (footnote), 393, 1128.
 गदन्हा के बच्चा *gadha ke bachcha*, 1128.
 गदहिया *gadahiya*, 1074, 1263.
 गदन्ही *gadhi*, 1074, 1128.
 गदन्हेड़ी *gadhenri*, 1128.
 गदी *gadi*, 226.
 गदीना *gadina*, 1073.

- गदेला *gadela*, 127, 213, 223, 1131.
 गंदौरा *gandaura*, 848.
 गद्दा *gadda*, 127, 209, 213, 877,
 940.
 गद्दी *gaddi*, 125, 126, 127, 223,
 226, 213, 371, 414, 451, 531,
 602, 1131.
 गद्दीवान *gaddivān*, 371.
 गधंपुरना *gadhypurna*, 1183.
 गंधवा *gandhwa*, 1074.
 गनन्ना बनब *ganna bancb*, 1343.
 गनेस *ganes*, 1203.
 गनौरा *ganaura*, 848.
 गन्धकी *gandhki*, 1074.
 गन्धी *gandhi*, 1074.
 गपन्ताल *gaptāl*, 1477.
 गपन्तुषा *gaptua*, 1074.
 गपन्तू *gaptu*, 1074.
 गपन्सू *gapsu*, 1074.
 गब्या *gabya*, 1157, 1272.
 गभन्तू *gabhtu*, 1074.
 गम्भरी *gambhri*, 965.
 गभरू *gabhrū*, 1281.
 गभा *gabha*, 957.
 गभा भेल बा *gabha bhail ba*, 957.
 गभौरी *gabhauri*, 894.
 गमन्हा *gamchha*, 724, 733.
 गमन्ही *gamchhi*, 733.
 गमन्ला *gamla*, 713.
 गमन्हेर *gamher*, 301.
 गमन्हा *gamhra*, 957.
 गमन्हा भेल अछि *gamhra bhel achhi*,
 957.
 गम्भरी *gambhri*, 965.
 गघा *gaya*, 1091.
 गघाल *gayāl*, 1477.
 गघाल खाता *gayāl khāta*, 1477.
 गर *gar*, 1098.
 गर औनन्धा *gar aundha*, 113.
 गरकी *gar ki*, 912, 1230.
 गरकी परनी *gar ki parti*, 912.
 गरजे *garje*, 1087.
 गरजै *garjai*, 1087.
 गरखी *garandi*, 919.
 गरन्दनी *gardani*, 889.
 गरन्दम *gardam*, 113.
 गरन्दवानी *gardavāni*, 261, 765.
 गरन्दानक *gardānak*, 1251.
 गरन्दानी *gardāni*, 261.
 गरन्दामी *gardāmi*, 261.
 गरन्दौव *gardāuv*, 113, 889.
 गरब खिजा *garab khilla*, 155.
 गरमी *garmi*, 1092, 1083.
 गरल *garal*, 1272.
 गरसी *garsī*, 765.
 गरह *garah*, 1252.
 गरहगर *garahgar*, 1252.
 गरहर *garhar*, 106.
 गरही *garhi*, 1207.
 गरही खरचा *garhi kharcha*, 1207.
 गरौंगट *garāngat*, 794.
 गरौंडी *garāuri*, 919.
 गरामन्ता *garāmta*, Appendix, 12a.
 गरारी *garāri*, 595.
 गरिषर *gariar*, 1098.
 गरिया *gariya*, 1014.
 गरीब *garib*, 414.
 गरे *gare*, 781.
 गरौंघा *garaundha*, 889.
 गरौंघन *garaundhan*, 113.
 गर्रा *garra*, 423.
 गलन्खोर *galckhor*, 113.
 गलन्जिन *galjin*, 724.
 गलन्जोती *galjoti*, 196.
 गलन्ठे *galthai*, 1143.
 गलन्ठे करब *galthai karab*, 1143.
 गलन्ता *galta*, 402.
 गलन्बल *galbal*, 1272.
 गलन्मोहा *galmoehha*, 724.
 गलल *galal*, 1004.

- गलसठका *galsatka*, 765.
 गलसेदी *galsedi*, 1316.
 गलची *galhi*, 235.
 गलियारी *galiyāri*, 489, 621.
 गलीचा *galcha*, 750.
 गलेचा *galacha*, 750.
 गलौधी *galaudhi*, 724.
 गलौसो *galausi*, 621.
 गल्लर *gallar*, 585.
 गल्ला *galla*, 890, 1468a, 1470, 1472, 1484.
 गल्ली *galli*, 489, 621, 832.
 गंवखा *ganckha*, 1011.
 गवत *gavat*, 1144.
 गवतचोर *garatchor*, 1146.
 गवन *gawan*, 1291, 1294.
 गवना *gawna*, 1291.
 गवा *gawa*, 1435.
 गवा लगाएब *gawa lagāēb*, 1435.
 गवा लेब *gāwa leb*, 1435.
 गवैदाँ *gavaiñyāñ*, 1207.
 गवैथाँ खरन्च *gavaiñyāñ kharch*, 1207.
 गहनी *gahni*, 234.
 गहन्रा *gahra*, 800.
 गह्या *gahua*, 411, 516, 552.
 गहुरे *gahurē*, 516.
 गहूम *gahum*, 955.
 गहूमन *gahuman*, 1136.
 गहूमा *gahuma*, 972, 985, 987.
 गहूली *gahuli*, 516.
 गहेडे *gaher*, 1124.
 गाई खरन्च, *gāñ kharch*, 1207.
 गाह *gāchh*, 585f, 994, 995.
 गाही *gāchhi*, 813, 814, 862, 990, 1001.
 गाँज *gānj*, 48, 646, 890, 894, 986.
 गाजड़ *gājur*, 1073.
 गाजर *gājar*, 1016, 1144.
 गाजा *gāja*, 318.
 गाँजा *gānja*, 44, 48, 1036.
 गाँजी *gānji*, 646.
 गाजी मीथाँ *gāji miyāñ*, 1456.
 गाँटा *gānta*, 1480.
 गाँठ *gānth*, 1480.
 गाँठा *gānthā*, 1480.
 गाँडर *gānrar*, 1075, 1183.
 गाड़ा *gāra*, 147, 150, 201, 1008.
 गाड़ी *gāri*, 147.
 गाह *gārh*, 858.
 गाहा *gācha*, 858.
 गान *gāt*, 120.
 गाना *gāta*, 38.
 गाँती *gānti*, 740.
 गाद *gād*, 790, 1001.
 गादर *gādar*, 877.
 गादा *gāda*, 877, 1001.
 गादुर *gādur*, 1074.
 गाँधो *gāndhi*, 1074.
 गामिन *gābhīn*, 1116.
 गाम *gām*, 394.
 गाथ *gāy*, 604, 1094, 1114, 1159.
 गाथ मोरू *gāy moru*, 1094.
 गार *gār*, 829, 951, 952.
 गारा *gāra*, 423, 1267.
 गाल *gāl*, 921, 990, 1002 (footnote), 1317.
 गाल नैकी *gāl senki*, 1317.
 गाली *gāli*, 489, 621, 729.
 गाँव के खरन्च *gāw ke kharch*, 1207.
 गाँव के ठाकुर *gāw ke thākur*, 1208.
 गावा *gāwa*, 1435.
 गासी *gāsi*, 13.
 गाहो *gahi*, 884.
 गिड़ी *gitti*, 1267.
 गिहाना *gihāna*, 1010.
 गिनब *ginab*, 1343.
 गिरई *giran*, 1480, 1481.
 गिरगिटिया *girgītiga*, 1037.
 गिरगिरा *girgira*, 646.

- गिरन्धर *girdhar*, 655.
 गिरन्दा *girda*, 399, 459, 924.
 गिरन्मिट *girmit*, 400, 405.
 गिरन्मी *girmi*, 1480, 1481.
 गिरल *giral*, 1080.
 गिरन्वी *gircin*, 1480.
 गिरलू *girastu*, 1160.
 गिरलू घू *girastu ghyu*, 1160.
 गिरह *girah*, 100, 1491.
 गिरहस *girhast*, 1085.
 गिरन्ही *girhi*, 1234.
 गिरानी *girāni*, 239.
 गिरामी *girāmi*, 239.
 गिरेह *gireh*, 1010, 1491.
 गिरे *gire*, 1010, 1491.
 गिरी *giron*, 1477, 1480.
 गिरी गॉठ *giron gānth*, 1480.
 गिलन्दाजी *gilundāji*, 1493.
 गिलावा *gilāva*, 423, 1246, 1267.
 गिलास *gilas*, 691.
 गिलेफ *gileph*, 730.
 गिलेवा *gileva*, 1267.
 गिलौरी *gilauri*, 1055.
 गौंगट *gingut*, 1266.
 गौर *gīr*, 965a.
 गुगुल *gugul*, 1419.
 गुच्चा *guchchha*, 233.
 गुजर *gujar*, 69.
 गुज्जरात *gujrat*, 1087.
 गुंजर्री *gunjri*, 533.
 गुज्जुरा *gujurua*, 270.
 गुंजेरा *gunjera*, 1183.
 गुडन्ना *gudra*, 975.
 गुड़ *gur*, 1014.
 गुड़न्का *gurki*, 372, 713.
 गुड़न्गुड़ी *gurguri*, 473.
 गुड़िया *guriya*, 188, 204, 221.
 गुड़ड़ा *gurura*, 1451.
 गुड़ौर *guraur*, 300.
 गुड़ी *gurhi*, 119.
 गुण्ड *gund*, 886.
 गुण्डो *gundo*, 894.
 गुडन्डा *gudra*, 637.
 गुदर *gudar*, 1048.
 गुदन्ना *gudra*, 731.
 गुदरी *gudri*, 731, 1048.
 गुदमन्ता *gudashta*, 1216.
 गुदमन्तादार *gudashtheadar*, 1216.
 गुदस्ता *gudasta*, 1216.
 गुदस्तादार *gudastādār*, 1216.
 गुदार *gudār*, 874, 886.
 गुदारा *gudāra*, 874.
 गुन *gun*, 747, 1457.
 गुन्धारी *gunthāri*, 638.
 गुनरन्खा *gunarkha*, 238.
 गुन्वाह *gunwāh*, 239.
 गुनिया *guniya*, 426.
 गुनियॉ *guniyān*, 404, 426.
 गुनी *guni*, 1453.
 गुन्नी *gunni*, 1343.
 गुम्मा *gunma*, 1272.
 गुर *gur*, 1014.
 गुरन्खा *gurkha*, 238.
 गुरन्चलन्ना *gurchalna*, 606.
 गुरन्दन *gurdan*, 309.
 गुरन्दम *gurdam*, 309, 319, 457.
 गुरन्दवान *gurdavān*, 1141.
 गुरन्देल *gurdel*, 66.
 गुरन्पौर *gurpaur*, 310.
 गुरन्हण्डी *gurhandi*, 314.
 गुरन्हतन *gurhatthan*, 1325.
 गुरन्हत्थी *gurhatthi*, 1325, 1347.
 गुरन्ही *gurhi*, 120.
 गुबज *guruj*, 402.
 गुबल खाप *gurujkhāp*, 402.
 गुरौधा *guraudha*, 1341.
 गुरौधा *guraundha*, 1325.
 गुलगुसा *gulgula*, 1272.
 गुलन्ठियाप्रब *gulthiyāēb*, 1024.
 गुलन्दाना *guldāna*, 1272.

गुल्दर *guldār*, 1138.
 गुल्फा *gulpha*, 1073.
 गुल्फी *gulphi*, 398.
 गुल्मिरीच *gulmirich*, 1073.
 गुलाब *gulāb*, 1043, 1272.
 गुलाब आम्रुन *gulāb jāmmu*, 1272.
 गुलाबी *gulābi*, 1043.
 गुलेती *guleti*, 66.
 गुलौरा *gulaura*, 1272.
 गुल्ला *gulla*, 1012.
 गुल्लो *gulli*, 32, 398, 602, 929, 932,
 936, 1008, 1012, 1042, 1272.
 गुंज *gūnj*, 469.
 गूर *gūr*, 1014, 1399, 1404, 1409.
 गूरक *gūrak*, 719.
 गूरा *gūra*, 886.
 गूरी *gūri*, 898, 1023.
 गूरा *gūrha*, 110, 233.
 गून *gūn*, 115, 239.
 गूर *gūr*, 311, 373, 1014, 1324.
 गूरी *gūri*, 1272.
 गेटजोरन *gethjoran*, 1331.
 गेटिया *gethiya*, 128.
 गेंडकीला *genrehhila*, 292.
 गेंडवहिद्या *genruwhiya*, 292.
 गेंडहरवा *gerharua*, 1075.
 गेंडारी *genrāri*, 832.
 गेंडिकाटा *genrikāta*, 293.
 गेंडिया *geriya*, 549.
 गेंडियार *geriyār*, 281.
 गेंडियार *genriyār*, 298.
 गेंरियारी *genriyāri*, 281, 298.
 गेंडुआ *gerua*, 688.
 गेंडुआ *genrua*, 652.
 गेंडुआवा *geñruāwa*, 1263.
 गेंडुडी *genrudi*, 652.
 गेंडुली *genruli*, 652.
 गेंदंडा *gendra*, 637.
 गेंदरा *gendra*, 731.
 गेंदरी *genhri*, 1073.

गेंदारी *genhāri*, 1073.
 गेंरुआ *gerua*, 119, 637, 1074.
 गेंरु *geru*, 1074, 1089.
 गेंलचयटा *gelhanta*, 1073.
 गेंलाह *gelāh*, 1070.
 गेंलै *gelai*, 1477.
 गेंलैन्हि *gelainhi*, 1486.
 गेंल्हनी *gellni*, 37.
 गेंचडिवाला *genhrivāla*, 1156.
 गेंऊ *gehu*, 955.
 गेंऊआ *genhuāa*, 985.
 गेंऊमा *gehuma*, 985.
 गेंऊ *gehūn*, 1092.
 गेंरम *getam*, 637.
 गेंठ *genth*, 1331.
 गेंठ जोड़ *geñth jor*, 1331.
 गेंठ बन्धन *genth bandhan*, 1331.
 गेंठा *gentha*, 108.
 गेंठि *geñthi*, 1357.
 गेंड *genr*, 1010, 1012, 1144.
 गेंडा *genra*, 873, 1008.
 गेंडा करल *genra karal*, 873.
 गेंडी *genri*, 288, 1008.
 गेंद खेलव *gend khelav*, 1386.
 गेरू *geru*, 786.
 गेल *gel*, 115 (footnote), 444, 859,
 922, 967, 987, 1004, 1043,
 1086, 1087, 1089, 1343, 1485.
 गेल्हा *gelha*, 141, 719, 1160.
 गेल्हा के घू *gelha ke ghū*, 1160.
 गेंघरा *gaighara*, 1153.
 गेंच *gainch*, 1256.
 गेंचा *gaincha*, 38.
 गेंता *gainta*, 38, 39, 115.
 गेंती *gdinti*, 38.
 गेंदान *gildān*, 1347.
 गेंना *gaina*, 1099.
 गेंघा *gaiya*, 1087.
 गेंर *gair*, 1215.
 गेंर सौहसी *gair maurūsi*, 1215.

गैल *gail*, 957, 1092, 1094, 1294,
 1477, 1485.
 गैल खाना *gail khāta*, 1477.
 गेवाह *gaiwāh*, 1150.
 गोआम *goām*, 919, 1201.
 गोआर *goār*, 1084, 1150, 1203.
 गोआरक *goārak*, 849 (footnote).
 गोआरें *goāren*, 1159.
 गोआस *goās*, 1132.
 गोईटा *goīta*, 1139.
 गोइठा *goītha*, 852, 853.
 गोईंठा *goīntha*, 852.
 गोइंठा घर *goītha ghar*, 853.
 गोऐंड *goēnr*, 784.
 गोऐंडा *goenra*, 784.
 गोखलू *gokhlu*, 533.
 गोखुला *gokhula*, 753, 1075.
 गोज ई *gojai*, 959.
 गोभन्नाटा *gojhnāta*, 741.
 गोभिया *gojhiya*, 1272.
 गोटाप्रल *gotāēl*, 957.
 गोठल *gothahul*, 853.
 गोठौर *gothaur*, 853.
 गोठौरा *gothaura*, 853.
 गोठौल *gothaul*, 853.
 गोठौला *gothaula*, 853.
 गोड़न्तार *gortār*, 638.
 गोड़न्धोआइ *gordhoāi*, 1341.
 गोड़न्धौठा *gorpautha*, 939.
 गोड़न्धौर *gorpaur*, 941, 949.
 गोड़न्हा *gorha*, 759.
 गोड़ॉइ *gorāin*, 759.
 गोड़ानी *gorāni*, 105, 110.
 गोड़ॉव *gorāuv*, 110, 759.
 गोड़ावन *gorāvan*, 110.
 गोड़ार *gorār*, 110.
 गोड़िया *goriya*, 188, 224, 225, 226,
 690, 1256.
 गोड़ैन *gorait*, 1200, 1209b ; Appen-
 dix, 12a.

गोड़ैनक *goraitak*, 1200.
 गोड़ैनक सूठ *goraitak mūth*, 1200.
 गोड़ैनी *goraiti*, 1200.
 गोधार *gothār*, 1145.
 गोँदरी *gondri*, 751.
 गोदाम *godām*, 312, 1139, 1488.
 गोँदौरा *gondaura*, 848.
 गोधन्ना *godhna*, 1183.
 गोनन्तारी *gontāri*, 638.
 गोनरी *gonri*, 751.
 गोनरौर *gonraur*, 848.
 गोनिया *goniya*, 426.
 गोपाल भोग *gopāl bhog*, 975.
 गोबन्नाइ *gobnāi*, 1456.
 गोबन्नाइ राखत *gobnāi rāūt*, 1456.
 गोबन्नाप्रल *gobnāēl*, 850.
 गोबन्नाौरा *gobraura*, 1074.
 गोबारा *gobāra*, 585.
 गोभन्नी *gobhni*, 40.
 गोरन्धिया *gorkhiya*, 845, 1150.
 गोरखल *gorkhul*, 753, 1075.
 गोरखी *goranti*, 786.
 गोरन्धरिया *gorthariya*, 638.
 गोरन्धारी *gorthāri*, 638.
 गोरन्धारो *gorthāro*, 1145.
 गोरन्दार रन्दा *gorlār randa*, 399.
 गोरन्दार रुखानी *gorlār rukhāni*, 400.
 गोरन्धोआइ *gordhoāi*, 1400.
 गोरन्धौर *gorpaur*, 280.
 गोरन्धौरो *gorpauri*, 614.
 गोरन्हा *gorha*, 852, 853.
 गोरिआइ *goriatta*, 786.
 गोरिया *goriya*, 1456.
 गोरआ *gorca*, 1456.
 गोरेँठिया *gorentiya*, 786.
 गोरेँठिया पधन्नी *gorentiya pathrauti*,
 786.
 गोरीआ *goraiya*, 1456.
 गोरीआ *goraulha*, 1341.
 गोल्भन्हा *golbhanta*, 1073.

गोलमुहूर्त्त *golmuhān*, 523.
 गोलमुहूर्त्त *golmuhān*, 523.
 गोलम्बा *golba*, 764, 768; 1135.
 गोलम्बा *golbān*, 378.
 गोलम्बाबर *golsābar*, 549.
 गोलम्बथ *golbath*, 963.
 गोलम्बली *golkatthi*, 963.
 गोलावा *golāva*, 1073.
 गोलौर *golaur*, 297, 300.
 गोसाँई *gosāñī*, 1456.
 गोसाउन *gosāun*, 1175.
 गोसाँया *gosāinya*, 393.
 गोहमा *gohma*, 970.
 गोहरा *gohra*, 852, 853.
 गोहराप्रब *gohrāēb*, 1098.
 गोहरौर *gohraur*, 853.
 गोहरौरा *gohraura*, 853.
 गोहान *gohān*, 784.
 गोहार *gohār*, 1201.
 गोहाल *gohāl*, 1153.
 गोहिया *gohiya*, 72, 1234.
 गोहूँ *gohuñ*, 955.
 गोहूम *gohum*, 955
 गोहूमन *gohuman*, 1136,
 गोघा *goa*, 653, 848, 868, 1006.
 गोघा पटाप्रब *goa patāēb*, 1006.
 गोखुल *gokhul*, 975, 978.
 गोखुल फूल *gokhul phul*, 975.
 गोखुल सार *gokhul sār*, 978.
 गोखा *gochha*, 233.
 गोखी *gochhi*, 1435.
 गोजर *gojar*, 69.
 गोजी *goji*, 654.
 गोभा *gojha*, 1272.
 गोँभी *gonjhi*, 1010.
 गोट *got*, 604, 984, 1045, 1127.
 गोटा *gota*, 765, 856, 984, 1045.
 गोटी *goti*, 327, 1032, 1175.
 गोटी के निकसारी *goti ke nik sāri*,
 1175.

गोटी घर *goti ghar*, 327.
 गोटी *goto*, 1045.
 गोठी *gotthi*, 337.
 गोठल *gotthul*, 853.
 गोड़ *gor*, 356, 1341, 1350, 1451.
 गोँड़ *gour*, 433.
 गोड़ घोड़ *gor dhoī*, 1341.
 गोड़ा *gora*, 78, 90, 362a.
 गोड़ी *gori*, 319j.
 गोँड़ी *gonri*, 93, 580.
 गोँड़ा *gourhā*, 784.
 गोद *god*, 1394.
 गोद लेब *god leb*, 1394.
 गोँदी *gondi*, 1251.
 गोधन *godhan*, 1446.
 गोन *gon*, 115, 128, 239.
 गोनर *gonar*, 849 (footnote), 849.
 गोप *gop*, 755.
 गोबर *gobar*, 848, 1445.
 गोबर पाँचे *gobar pāuche*, 1445.
 गोभी *gobhi*, 1009, 1011, 1074.
 गोर *gor*, 1337, 1338, 1400.
 गोरख *gorakh*, 756, 769.
 गोरख धंधारी *gorakh dhandhāri*, 756.
 गोरख धन्धारी *gorakh dhankhāra*, 756,
 769.
 गोर लगप्रब *gor lagāēb*, 1337, 1351.
 गोरस *goras*, 1157.
 गोरा *gora*, 1216.
 गोरी *gori*, 786.
 गोरी केवाल *gori kewāl*, 786.
 गोरू *goru*, 1094.
 गोल *gol*, 236, 418, 748, 756, 769,
 921, 1037, 1073, 1113, 1135,
 1259, 1260.
 गोलक *golak*, 399, 400, 418.
 गोलक बुदज खाब *golak buruj khāb*,
 399.
 गोलख *gotakh*, 400, 418.
 गोल गाल *gol gāl*, 921.

गोल मिरिच *gol mirich*, 1073.
 गोलम्बर *golambar*, 921.
 गोल रेती *gol reti*, 418.
 गोला *gola*, 424, 466, 585, 1016,
 1113, 1135, 1259, 1260, 1272.
 गोलाकस *golākas*, 424.
 गोला रुखानी *gola rukhāni*, 400.
 गोली *goli*, 77, 498, 505, 549.
 गोली सबरी *goli sabri*, 549.
 गोसल *gosal*, 1408, 1430.
 गोसल कराच *gosal karāch*, 1408,
 1430.
 गोहट *gohat*, 865.
 गौतन्दा *gautha*, 1144.
 गौनचऱी *gaunahri*, 1293.
 गौरिया *gauriya*, 991.
 गौरैया *gauraiya*, 473.
 गौसाला *gausāla*, 1153.
 गौसिङ्गी *gausinghi*, 1102.
 गौ *gau*, 637, 1114, 1451.
 गौँआ *gauñā*, 1208.
 गौ किरिया *gau kiriya*, 1451.
 गौ कोस *gau kos*, 1492.

गौखा *gaukha*, 1139.
 गौच *gauch*, 400.
 गौँची *gaunchi*, 789.
 गौँही *gaunchhi*, 789, 1074.
 गौठि *gauthi*, 848.
 गौठी *gauthi*, 848.
 गौँडा *gaunra*, 784.
 गौत *gaut*, 848, 1144.
 गौँत *gaunt*, 848.
 गौ तकिया *gau takiya*, 637.
 गौत देब *gaut deb*, 1145.
 गौँती *gaunti*, 884.
 गौदान *gaulān*, 1347.
 गौना *gauna* 1291, 1349.
 गौना के नेशार *gauna ke neār*, 1349
 गौर *gaur*, 1118.
 गौरी *gauri*, 93.
 गौला *gaula*, 236.
 गौसार *gausār*, 1153.
 ग्राम *grām*, 1455.
 ग्राम देखोता *gram deota*, 1455.
 ग्वार *gvār*, 1150.
 गिही *grihi*, 1234.

॥ घ gh ॥

घरे *gharē*, 835.
 घग्घा *ghaggha*, 1084.
 घँघरा *ghanghra*, 743.
 घघरी *ghaghri*, 34, 1088.
 घँघरी *ghanghri*, 743, 1074.
 घङ्गर *ghanghar*, 743.
 घटक *ghatak*, 1286.
 घटना *ghatna*, 3191, 718.
 घटऱा *ghatra*, 1272.
 घटिहन *ghatihan*, 1272.
 बटोरा *ghatora*, 1272.
 घडा *ghattha*, 1272.
 घटिहन *ghathihan*, 1272.
 घडा *ghara*, 32.

घडारी *gharāri*, 832, 940.
 घड़िया *ghariya*, 530, 547, 554, 560,
 621.
 घड़ी *ghari*, 595, 776.
 घड़ौँची *gharaunchi*, 722.
 घण्ट *ghant*, 776, 1422.
 घण्ट टांगव *ghant tāngab*, 1422.
 घण्टा *ghanta*, 776.
 घन *ghan*, 397, 410, 552, 585, 858.
 घन चक्कर *ghan chakkar*, 585.
 घनमुधो *ghanmudhi*, 409.
 घनबहा *ghanbaha*, 295.
 घनवादा *ghanvāda*, 283, 295.
 घनी *ghani*, 646.

- घनैली *ghanaili*, 646.
 घर *ghar*, 268, 312, 853, 895, 1089,
 1162, 1234, 1235, 1244, 1248,
 1275, 1350, 1388, 1390.
 घरत *ghara*, 1234.
 घरन्का *gharka*, 1250.
 घर के लोग *ghar ke log*, 1275.
 घरन्घरन्वा *ghargharwa*, 1173.
 घर हरिया *ghar chhariya*, 1244.
 घरन्नेई *gharnaī*, 232.
 घरन्नी *gharanni*, 566.
 घर पैसारी *ghar paisāri*, 1350.
 घरन्बारी *gharbāri*, 784.
 घर भरब *ghar bharab*, 1388, 1390.
 घरन्रा *gharra*, 271.
 घरन्गी *gharri*, 595.
 घरन्हु *gharhu*, 1092.
 घरा *ghara*, 1234, 1251.
 घरामी *gharāmī*, 1244.
 घरिया *ghariya*, 530, 547, 551, 557,
 713.
 घरिल *gharil*, 713.
 घरगे *gharog*, 1234.
 घलन्थरी *ghalthari*, 722.
 घलन्सारी *ghalsāri*, 722.
 घलन्ना *ghalna*, 1483.
 घसन्कट्टी *ghaskatti*, 1359.
 घसन्तुरिया *ghasturiya*, 1119.
 घसन्ना *ghasna*, 1272.
 घसन्नेई *ghasni*, 1272.
 घसन्ने रोटी *ghasni roti*, 1272.
 घाद *ghāi*, 34.
 घाघ *ghāgh*, 1091, 1092.
 घाँघर *ghānghar*, 743.
 घाघे *ghāghe*, 829.
 घाट *ghāt*, 1420.
 घाटों *ghāton*, 1456.
 घाठ *ghāth*, 1272.
 घाठा *ghātha*, 1272.
 घाठि *ghāthi*, 1272.
 घाठो *ghātho*, 1272.
 घाँठो *ghāntho*, 1272.
 घानी *ghāni*, 263, 444.
 घामँइ *ghāmanr*, 487.
 घारौ *ghāri*, 1153.
 घास *ghās*, 356, 868.
 घास पान *ghās pāt*, 868.
 घिजरा *ghijra*, 1069.
 घिदारी *ghidhāri*, 1368.
 घिना *ghina*, 848.
 घियौड़ा *ghiyāura*, 1272.
 घिरन्ची *ghirchi*, 335.
 घिरन्नेई *ghirnaī*, 595.
 घिरन्ना *ghirna*, 596.
 घिरन्नी *ghirni*, 238, 595, 940.
 घिरन्सण्डी *ghirsandi*, 722.
 घिरन्सिद्दी *ghirsārdi*, 722.
 घिरन्सिन्डी *ghirsindi*, 722.
 घिरन्सिर *ghirsir*, 722.
 घिवक *ghivak*, 140.
 घिवक कड़न्चा *ghivak karha*, 140.
 घिवक कड़न्ची *ghivak karhi*, 140.
 घिवन्ही *ghivahi*, 140.
 घिवन्ही भाँड़ा *ghivahi bhāura*, 140.
 घिमिरी *ghisiri*, 722.
 घी *ghi*, 1160.
 घीव *ghiv*, 1160.
 घीवर *ghivar*, 1272.
 घुगुरी *ghuguri*, 1272.
 घुग्घा *ghuggha*, 741.
 घुघन्नी *ghughni*, 990, 1272.
 घुँघन्नी *ghungani*, 990.
 घुँघन्हु *ghungaru*, 759.
 घुघुहु *ghughura*, 771.
 घुँघुहु *ghunghura*, 771.
 घुङ्घुर *ghuzghur*, 759.
 घुञ्चा *ghuchhi*, 713.
 घुण्डी *ghundi*, 612, 729, 767.
 घुनन्सी *ghunsi*, 755.
 घुमन्नी *ghumni*, 1177.

घुमाप्रब *ghumācb*, 830, 1098, 1332.
 घुमान *ghumān*, 954.
 घुमौषा जाल *ghumaua jāl*, 646.
 घुरकटा *ghurkatta*, 292.
 घुरन्ची *ghurchi*, 335.
 घुरन्चीला *ghurchīla*, 115.
 घुरन्नी *ghurni*, 940, 1177.
 घुरन्ला *ghurla*, 136.
 घुरिल्ली *ghūriili*, 713.
 घुसिआबे *ghusiābe*, 1446.
 घूआ *ghūa*, 984.
 घूघ *ghūgh*, 741.
 घूंडी *ghūndi*, 729.
 घून *ghūn*, 1074.
 घूनी *ghūni*, 1024.
 घूर *ghūr*, 848, 849, 873, 1247,
 1400.
 घूर काटब *ghūr kātab*, 873.
 घूरी *ghūri*, 889.
 घेघुआ *gheghua*, 1173.
 घेबल्लौ *ghebli*, 1000.
 घेरान *gherān*, 895, 1148.
 घेरानी *gherāni*, 1148.
 घेवन्डा *ghewra*, 1069.
 घेवारी *ghewāri*, 832.
 घेंच *ghench*, 1073.
 घेरल *gheral*, 1485.
 घेरा *ghera*, 895, 919, 1132, 1148,
 1311.
 घेवर *ghewar*, 1272.
 घैलन्गारी *ghailsāri*, 722.
 घैला *ghaila*, 83, 303, 432, 713.
 घैली *ghaili*, 713.
 घोंगरा *ghongra*, 1100.
 घोंघन्डी *ghonghri*, 1074.
 घोंघन्डुलन्वा *ghonghphulwa*, 1173.
 घोंघन्वा *ghonghra*, 1100.
 घोंघन्वा *ghonchwa*, 1100.
 घोंटारे *ghoñtāri*, 1310, 1314.
 घोङ्गुहा *ghormhān*, 1256.

घोङ्गुहा *ghorsaha*, 1256.
 घोङ्गिया *ghoriya*, 225.
 घोनन्सार *ghonsār*, 434, 435.
 घोनन्सारी *ghonsāri*, 434,
 घोरन्जाउर *ghorjāur*, 1272.
 घोरन्जारी *ghorjāri*, 1272.
 घोरन्माहा *ghormāha*, 143.
 घोराद *ghorādi*, 639, 936.
 घोराठी *ghorāthi*, 144.
 घोरान *ghorān*, 895, 1148.
 घोरानी *ghorāni*, 936.
 घोघ *ghogh*, 741.
 घोघट *ghoghat*, 741.
 घोघर *ghoghur*, 1458.
 घोघर *ghonghar*, 1100.
 घोघा *ghongha*, 725, 1267.
 घोघी *ghoghi*, 734, 737.
 घोघी *ghonghi*, 737.
 घोघो *ghogho*, 741.
 घोघा *ghoncha*, 1100.
 घोघट *ghoñtab*, 1310.
 घोटन *ghotan*, 1310.
 घोटा *ghonta*, 539.
 घोड *ghor*, 148, 1126.
 घोड बचल *ghor bakal*, 148.
 घोडा *ghora*, 1126.
 घोडी *ghori*, 386, 1126, 1127, 1250
 घोपा *ghonpa*, 987, 1100.
 घोर *ghor*, 749, 1126, 1161, 1166,
 1272.
 घोरन *ghoran*, 639.
 घोरा *ghora*, 1126.
 घोरी *ghori*, 1126.
 घोल *ghol*, 1272.
 घोली *gholi*, 1483.
 घोद *ghaud*, 379.
 घौर *ghaur*, 379, 1234.
 घुढारी *ghyudhāri*, 1308.
 घु *ghyū*, 138, 713, 719, 1160,
 1272, 1308.

- चक *chak*, 629.
 चकट्टी *chakti*, 209.
 चकठ *chakath*, 1225, 1227.
 चकन्नी *chakti*, 209.
 चकम्मक *chakmak*, 1091.
 चकरन्वान *chakarvān*, 585.
 चकरन्सान *chakarsān*, 538.
 चकरी *chakri*, 581, 619, 932, 1014.
 चकला *chakla*, 457, 629.
 चकलेदार *chakledār*, 871.
 चकवर *chakvar*, 579.
 चकुला *chakula*, 619.
 चकैठ *chakaith*, 573.
 चकोड़ा *chakora*, 1183.
 चकोड़ी *chakori*, 579.
 चकोला *chakola*, 629.
 चकर *chakkar*, 360, 585, 590, 1112.
 चकस *chakkas*, 447.
 चका *chakka*, 151, 590, 1253, 1272.
 चकी *chakki*, 581, 590, 619, 1014, 1251, 1369.
 चंगनी *changni*, 1483.
 चंगरी *changeri*, 44.
 चंगेली *changeli*, 44.
 चंगोर *changor*, 45.
 चघूस *chaghūs*, 147.
 चघूस गाड़ी *chaghūs gāri*, 147, 150.
 चचरा *chachra*, 937.
 चचरी *chachri*, 1416.
 चचार *chachār*, 233, 937.
 चचर *chanchar*, 1234.
 चचर घर *chanchar ghar*, 1234.
 चटका *chatka*, 735.
 चटकोहा *chatkoha*, 1004.
 चटना *chatna*, 1458.
 चटनी *chatni*, 1272.
 चटाई *chatāi*, 197, 751, 1450.
 चटान *chatān*, 751, 794, 1266.
 चटावन *chatāvan*, 1407.
 चटिया *chatiya*, 1453.
 चट्टा *chatua*, 1458.
 चट्टेनी *chataini*, 751.
 चट्टैल *chatail*, 1073.
 चट्टा *chatta*, 1004.
 चट्टा धरिस है *chatta dharis hai*, 1004.
 चट्टान *chattān*, 1266.
 चट्टी *chatti*, 317, 304, 319m, 456, 713, 750.
 चट्टैल *chuthail*, 1073.
 चट्टिया *chattiya*, 713.
 चट्टियार *chattiyār*, 949.
 चट्टिवाह *chattivāh*, 949.
 चढ़ *chark*, 1173.
 चढ़त *charhat*, 1085.
 चढ़ब *charhab*, 1021.
 चढ़ाग्रब *charhācb*, 1308, 1378.
 चढ़ाव *charāo*, 951.
 चढ़ि *charhi*, 726 (footnote).
 चण्ड *chandi*, 1034.
 चतत्रा *chatra*, 1074, 1105.
 चतावन *chatāvan*, 1456.
 चतुरथी *chaturthi*, 1340, 1357.
 चन्द्रौटा *chandrauta*, 778.
 चन्द्रा *chandra*, 7, 183.
 चन्द्रिया *chandriya*, 269.
 चन्दुली *chanduli*, 7.
 चहूर *chahur*, 323, 724, 730, 740, 1339, 1386.
 चनकी *chanki*, 786.
 चनडोल *chandol*, 241.
 चनमार *chanmār*, 1251.
 चनवा *chanva*, 269.
 चनसुर *chansur*, 1073.
 चना *chana*, 1002.

- चनावक *chanābak*, 965c.
 चानी *chani*, 1003.
 चन्दन *chandana*, 778, 1318, 1391.
 चन्दन हार *chandana hār*, 1391.
 चन्दर *chandar*, 585.
 चन्दर कला *chandar kala*, 585.
 चन्द्र हार *chandar hār*, 765.
 चन्ना *channa*, 1047, 1048.
 चपई *chapai*, 136, 1043.
 चपकन *chapkan*, 729.
 चपटन्वा *chapatwa*, 1074.
 चपटा *chapta*, 735, 1037.
 चपोट *chapot*, 179.
 चपड़ा *chupra*, 1075.
 चपनी *chapni*, 492.
 चपरावन *chaprāvan*, 409.
 चपरावना *chapravana*, 409.
 चपरावनी *chapravani*, 409.
 चबुतरा *chabutra*, 317, 1243.
 चबैना *chabena*, 1272.
 चबैनी *chabeni*, 1272.
 चभुकी *chabhuki*, 99.
 चमच *chamach*, 449.
 चमड़ा *chamra*, 414, 1139.
 चमड़ी *chamri*, 719.
 चमकार *chamākār*, 1056.
 चमरख *chamrakh*, 349.
 चमरा *chamra*, 362a.
 चमाइनि *chamāini*, 1400.
 चमार *chamār*, 479, 1196.
 चमैनी *chamaini*, 1400, 1408, 1412.
 चमौटा *chamauta*, 383.
 चमौटी *chamauti*, 383.
 चम्पा *champa*, 138, 140, 765.
 चम्पा कली *champa kali*, 765.
 चमच *chammach*, 449.
 चम्मल *chammal*, 507.
 चर *char*, 1120.
 चरचनी *charanni*, 1479.
 चरक *charak*, 597, 1133.
 चरका *charka*, 1133.
 चरको *charko*, 1133.
 चरख *charukh*, 498, 540, 598.
 चरखा *charkha*, 339.
 चरखी *charkhi*, 329, 585a, 598.
 चरगोटिया *chargotiya*, 639.
 चरगोरी *chargori*, 31.
 चरचसी *charchasi*, 821.
 चरँदिया *charanchhiya*, 1248.
 चरँदिया चूल्हा *charanchhiya chulha*,
 1248.
 चरन *charan*, 93.
 चरना *charna*, 726.
 चरनी *charni*, 93.
 चरपतिया *charpatiya*, 1018.
 चरपतियो *charpatiyo*, 1018.
 चरपलिया *charpaliya*, 725.
 चरपाइ *charpāi*, 636, 1416.
 चरपाय *charpāy*, 243.
 चरवन *charvan*, 1272.
 चरवरन्धा *charbardha*, 1097.
 चरवा *charwa*, 1126.
 चरवाह *charwāh*, 1150, 1184.
 चरवाहा *charwāha*, 845, 1150.
 चरवाही *charwāhi*, 833, 1152, 1205.
 चरस *charas*, 1036.
 चरसा *charsa*, 1139, 1201.
 चरसा के गोदाम *charsa ke godām*,
 1139.
 चरसेरा *charsera*, 1500.
 चरसेरी *charseri*, 1500.
 चराइ *charāi*, 1147, 1151, 1152,
 1205 ; Appendix, 14.
 चराँट *charānt*, 1147.
 चरी *chari*, 1144, 1183.
 चरवा *charwa*, 83, 316, 467, 713.
 चरवै *charvāi*, 467, 713.
 चरैया *charaiya*, 1174.
 चरैया *charaila*, 1248.
 चरैया चूल्हा *charaila chulha*, 1248.

- चला *chala*, 1088.
 चलग्ना बटाम *chalta batām*, 404.
 चलग्ना *chalna*, 39, 325, 440, 606.
 चलन्नी *chalni*, 440, 604.
 चलल *chalaḷ*, 356.
 चललह *chalalah*, 1113.
 चलाएब *chalāeb*, 817, 830, 941, 949.
 चलाँकी *chalānki*, 519.
 चले *chale*, 478.
 चलौना *chalouna*, 346.
 चालौनी *chalauni*, 56, 331, 346, 439, 446.
 चलाँसी *chalaunsi*, 894.
 चल्हा *challha*, 1155.
 चंवर *chamvera*, 1133.
 चसन्दार *chasdār*, 742.
 चहङ्का *chahka*, 585.
 चहन्टा *chahṭa*, 1458.
 चहबच्चा *chahbucchā*, 314, 316.
 चहल *chahal*, 787.
 चाई *chāin*, 594.
 चाउर *chāur*, 963, 1365.
 चाज *chāj*, 1084.
 चाक *chāk*, 79, 573, 629.
 चाकर *chākar*, 1184.
 चाकल *chākal*, 893.
 चाकी *chāki*, 1014.
 चाकैटा *chākaita*, 1263.
 चाँग *chāng*, 49, 895, 970.
 चाँच *chānch*, 799.
 चाँचर *chānchar*, 1154.
 चाँचरी *chānchri*, 318.
 चाँचन्वाला *chānchwāla*, 1234.
 चाँचन्वाला घर *chānchwāla ghar*, 1234.
 चाँची *chānchhi*, 1144.
 चाढे *chāṭai*, 250.
 चाँड़ *chām*, 117, 442, 949.
 चाँड़ा *chānra*, 1259.
 चाँडा *chānda*, 1259.
 चाँड़ी *chānri*, 24, 1259.
 चाँड़ू *chāndu*, 1034.
 चानर *chānar*, 382, 646, 1105.
 चाँद *chānd*, 226, 585, 762.
 चाँद चरन्धी *chānd charnhi*, 585.
 चाँदन्नी *chāndni*, 1178, 1235.
 चादर *chādar*, 585, 730, 740, 745.
 चादर पड़ाकेदार *chādar parākedār*, 585.
 चाँदिल *chāndil*, 816.
 चाँदी *chāndi*, 7.
 चान *chān*, 1088, 1091.
 चाँप *chāmp*, 816.
 चाँपा *chāmpa*, 518, 748.
 चाँपा बखिया *chāmpa bakhiya*, 748.
 चाँपी *chāmpi*, 136, 140.
 चाबुक *chābuk*, 104.
 चाभी *chābhi*, 1250.
 चाभुक *chābhuk*, 99.
 चाम *chām*, 414, 1139.
 चार *chār* 821, 1244.
 चारगनाइ *chārgnāi*, 636, 1131.
 चार चास *chār chās*, 821.
 चारा *chāra*, 1144, 1183.
 चारि *chāri*, 1087, 1113.
 चारो *chāro*, 1183.
 चालन *chālan*, 866.
 चालनि *chālni*, 410, 604.
 चालग्ना *chālsa*, 914.
 चाली *chāli*, 179, 233, 327, 429, 750.
 चाल्हा *chālha*, 1155.
 चावल *chāval*, 963.
 चास *chās*, 801, 817, 818, 819, 821, 823, 828, 1089, 1192.
 चाहा *chāha*, 419, 527.
 चाहिय *chāhya*, 741 (footnote).
 चिउरी *chīuri*, 1272.
 चिक *chik*, 1141.
 चिकठ *chikath*, 1225, 1227.

- चिकनकौर *chikankaur*, 1146.
 चिकनजिबो *chikanjibho*, 1146.
 चिकना *chikna*, 1045, 1160, 1166.
 चिकनिया *chikaniya*, 1146.
 चिकनी *chikni*, 713, 786, 1183.
 चिकनी मिट्टी *chikni mitti*, 786.
 चिकनी हाँड़ी *chikni hāvi*, 713.
 चिकस *chikas*, 1272.
 चिकसा *chiksa*, 1272.
 चिकन *chikkan*, 786, 849n.
 चिकन मिट्टी *chikkan mitti*, 786.
 चिकस *chikkas*, 1272.
 चिखुरनी *chikhurni*, 867.
 चिखुरा *chikhurā*, 869.
 चिखोर *chichhor*, 1075, 1183.
 चिचिरा *chichira*, 1072.
 चिचुरा *chichura*, 1072.
 चिचोरी *chichori*, 1183.
 चिचोर *chichor*, 1075, 1183.
 चिचोरी *chichori*, 1075.
 चिचोरो *chichoro*, 1183.
 चिट *chit*, 726, 1464.
 चिटुरा *chitura*, 1004, 1031.
 चिटुरा लागल है *chitura lāgal hai*,
 1004.
 चिट्ठा *chittha*, 1464, 1483.
 चिट्ठी *chitthi*, 1344, 1464, 1487.
 चितरसेली *chitarseti*, 1073.
 चित्रा *chitra*, 1082, 1089.
 चिता *chita*, 1419, 1422.
 चितावा *chitāva*, 994.
 चिता सेराग्र *chita serāēb*, 1422.
 चितियाग्र *chītiyāēb*, 1024.
 चित्ती *chitti*, 1024, 1391.
 चित्ती कौड़ी *chitti kauri*, 1391.
 चिनमार *chinmār*, 1247.
 चिनवा *chinva*, 1183.
 चिमिया *chiniya*, 1005.
 चिनियाँ *chiniyān*, 1005.
 चिन्ना *chinna*, 991.
 चिन्नी *chinmi*, 1014.
 चिपग्या *chipta*, 1037.
 चिपरी *chipri*, 852.
 चिमन्टा *chimta*, 516, 539, 567, 703,
 711, 1033.
 चिमन्टी *chimti*, 516.
 चिरकदान *chirakdān*, 702, 1253.
 चिरकुटवा *chirkutva*, 1456.
 चिरकुटवा पीर *chirkutva pīr*, 1456.
 चिरचिरा *chirchira*, 1380, 1385.
 चिरचिरी *chirchiri*, 1183.
 चिरना *chirna*, 424.
 चिरमिच्ची *chirmichechi*, 707.
 चिराक *chirāk*, 713.
 चिराग *chirāg*, 713, 1423.
 चरागदान *chirāgdān*, 702, 711.
 चिराग बत्ती *chirāg batti*, 1423.
 चिरागा *chirāga*, 1441.
 चिरागाह *chirāgāh*, 1147.
 चिरार *chirār*, 1418.
 चिरारी *chirāri*, 1418.
 चिरैया *chiraiya*, 194, 967, 1082,
 1086.
 चिरौगिया *chiraugiya*, 769.
 चिलम *chilam*, 472, 713, 1026, 1034.
 चिलमन्ची *chilamchi*, 699.
 चिलम्वन *chilwan*, 605.
 चिलिफन्ची *chiliphchi*, 699.
 चिलिमन्ची *chilimechi*, 699, 711.
 चिलोही *chilohi*, 73.
 चिलौज *chilauj*, 605.
 चिलौद *chilaund*, 605, 646.
 चिलौन *chilaun*, 605.
 चिलम *chillam*, 472.
 चिहल *chihal*, 1375.
 चिहल तन *chihal tan*, 1375.
 चिहकार *chihukar*, 1098.
 चीज *chij*, 655.
 चीक *chik*, 1141.
 चीन *chin*, 474, 475, 990, 991, 1084.

- चीना *chīna*, 991, 1074.
 चीनी *chīni*, 312, 1014.
 चीनी के कारखाना *chīni ke karkhāna*,
 312.
 चीनी के गोदाम *chīni ke godām*, 312.
 चीन्ह *chīnh*, 991.
 चीप *chīp*, 184, 427.
 चीर *chīr*, 723.
 चीरा *chīra*, 724, 1265.
 चुआरी *chuāri*, 920c.
 चुक *chuk*, 1084.
 चुकड़ी *chukri*, 136, 713.
 चुकनी *chukni*, 713.
 चुकल *chukal*, 834.
 चुकिया *chukiya*, 249.
 चुकौआ *chukaua*, 1220.
 चुकड़ *chukkar*, 372, 713.
 चुकर *chukkar*, 713.
 चुका *chukka*, 136, 140, 146, 713.
 चुकी *chukki*, 136.
 चुचुहिया *chuchuhiya*, 1077.
 चुटकी *chutki*, 417, 857, 1201, 1483.
 चुड़िदार *churidār*, 727, 749.
 चुड़िया *churiya*, 561.
 चुड़िहार *churihār*, 561.
 चुड़ेल *churail*, 1458.
 चुण्टा *chunta*, 567.
 चुंदरी *chundri*, 745.
 चुनरी *chunri*, 745, 1316.
 चुनवटल *chunvattal*, 1267.
 चुनवा *chunha*, 659.
 चुनेटल *chunetal*, 1267.
 चुनौटी *chunauti*, 659.
 चुमा *chunna*, 69, 659, 1267.
 चुमी *chunni*, 1272.
 चुभकी *chubhki*, 570.
 चुभनी *chubhti*, 570.
 चुमाप्रब *chumārb*, 1304.
 चुमावन *chumāvan*, 1279, 1304.
 चुमाणा *chumauna*, 1279, 1304, 1312.
 चुरिया *churiya*, 60, 568.
 चुरिहार *churihār*, 561.
 चुलहोंका *chuljhonka*, 303.
 चुलाप्रब *chulārb*, 855.
 चुल्हचचा *chulhancha*, 303.
 चुल्हानी *chulhāni*, 1248.
 चुल्हिया *chulhiya*, 1248.
 चुसकी *chuski*, 1035.
 चुस *chust*, 727.
 चुहटाब *chuhṭāb*, 1158.
 चुहड़ *chuhar*; 1456.
 चुहड़ माल *chuhar māl*, 1456.
 चुहाड़ *chuhār*, 1119.
 चुहानी *chuhāni*, 1248.
 चुआना *chūana*, 1246.
 चुआना मारब *chūana mārāb*, 1246.
 चुआँ *chūān*, 578, 920c.
 चुआँ *chūān*, 920c.
 चुआ *chūe*, 1084.
 चुका *chūka*, 146.
 चुंटा *chūnta*, 516, 567, 703.
 चुंटी *chūnti*, 516, 539, 567, 1033.
 चुड़ा *chūra*, 1272.
 चुड़ी *chūri*, 571.
 चुड़ *chūrkh*, 1250.
 चुन *chūn*, 659, 748, 1025, 1267,
 1272.
 चुनब *chūnāb*, 1389, 1390.
 चुना *chūna*, 69, 1267.
 चुना फेरल *chūna pheral*, 1267.
 चुर *chūr*, 155, 256, 638, 768, 771,
 977, 978, 1037, 1250.
 चुरा *chūra*, 1272.
 चुरी *chūri*, 768, 771.
 चुल *chūl*, 155, 638, 1250.
 चुल्ह *chūlh*, 1247.
 चुल्हा *chūlha*, 312, 301, 435, 454,
 1247, 1248, 1306, 1312, 1313,
 1377.
 चुल्हा के घर *chūlha ke ghar*, 312.

- चूल्हिक *chūlhik*, 1087.
 चूल्ही *chūlhi*, 1247.
 चूल्हो *chūlho*, 1247.
 चेंगवा बैंगन *chengwa baingan*, 1073.
 चेंपुषा *chepua*, 1012.
 चेंफन्ही *chephri*, 738.
 चेंफुषा *chephua*, 290.
 चेंपुषा *chepua*, 713.
 चेंवर *cherü*, 83, 713.
 चेंलन्ही *chelkhi*, 11.
 चेंलन्वा *chelwa*, 1155.
 चेकी *cheki*, 1251.
 चेंघी *chenghi*, 155.
 चेंच *chench*, 1183.
 चेचक *chechak*, 1175.
 चेंट *chent*, 726.
 चेंडा *cheüra*, 1261.
 चेंदी *chendi*, 165.
 चेनी *cheni*, 165.
 चेन्ही *chenhi*, 165.
 चेपी *chepi*, 1251.
 चेरी *cheri*, 11.
 चेला *chela*, 1261.
 चैन *chai*, 1082, 1084, 1092.
 चैना *chaita*, 809.
 चैती *chaiti*, 1419.
 चैला *chaila*, 1261.
 चैली *chaili*, 11, 401, 1261.
 चोकनी *chokni*, 452.
 चोकरा *chokra*, 894.
 चोंगिया *chongiya*, 416.
 चोरनी *chorni*, 1117.
 चोरसा *chorsa*, 403.
 चोराइ *chorāi*, 1336.
 चोरांट *chorānt*, 1183.
 चोरांट *chorānta*, 1183.
 चोरावै *chorāwai*, 763.
 चोचाट *chohāt*, 1119.
 चोचैर *chohair*, 1119.
 चोकन *chokan*, 452.
 चोकर *chokar*, 894.
 चोंकर *chonkar*, 894.
 चोका *choka*, 452.
 चोखा *chokha*, 800, 1272.
 चोंगा *chonga*, 24, 381, 414, 510, 495.
 चोंगी *chongi*, 414, 510.
 चोट *chot*, 356, 408, 719.
 चोंटी *chonti*, 155, 761.
 चोद *chourh*, 1117.
 चोंदी *chonrhi*, 1117.
 चोत *chot*, 848.
 चोंथा *chontha*, 1272.
 चोना *chona*, 270.
 चोन्ही *chonhi*, 155.
 चोप *chop*, 124.
 चोंप *chomp*, 124.
 चोपा *chopa*, 1012.
 चोभा *chobha*, 385.
 चोभी *chobhi*, 13, 90.
 चोर *chor*, 572, 1173, 1184.
 चोरक *chorak*, 726 (footnote), 1184.
 चोर-किल्ली *chorkilli*, 929.
 चोर मटका *chor matka*, 1173, 1458.
 चोली *choli*, 744.
 चोहट *chohat*, 1456.
 चौएठा *chauetha*, 828.
 चौकवा *chauktha*, 754, 762.
 चौकन्ही *chaukthi*, 141.
 चौकला *chaukla*, 629.
 चौकैठा *chauketha*, 828, 857.
 चौगथिया *chaugathiya*, 828.
 चौगानी *chaugāni*, 473e.
 चौगोशिया *chaugoshiya*, 725.
 चौगोरा *chaugora*, 31, 382.
 चौघड़ा *chaughara*, 585f.
 चौघाँव *chaugānw*, 953.
 चौघावा *chaughāwa*, 953.
 चौठारी *chauthāri*, 1340.
 चौठैया *chauthaiya*, 910, 1017, 1053.
 चौतरा *chautra*, 436, 722, 1243.

चौताना *chautāna*, 585.
 चौथारी *chauthāri*, 1340, 1391.
 चौथैया *chauthaiya*, 910, 1201.
 चौधरी *chaudhri*, 1452.
 चौपट्टा *chaupatta*, 1075.
 चौपतिघा *chaupatiya*, 1018.
 चौपहल *chaupahal*, 403.
 चौपहल रेतनी *chaupahal retī*, 403.
 चौबगल्ली *chaubagli*, 828.
 चौबटिया *chaubatiya*, 833.
 चौबधिया *chaubadhiya*, 639.
 चौबरग्दा *chaubarda*, 31, 149.
 चौमण्डी *chaumandī*, 828.
 चौमसिया *chaumasiya*, 1008.
 चौरन्सा *chaurasa*, 399, 403, 470, 531, 557.
 चौरन्सी *chaurasi*, 557.
 चौरासी *chaurāsi*, 759.
 चौराहा *chaurāha*, 833, 1221.
 चौरेठा *chaurētha*, 1272.
 चौहटा *chauhatta*, 544.
 चौआ *chāua*, 736, 1094, 1489, 1490, 1495.
 चौक *chauk*, 223, 828.
 चौक *chauk*, 1347.
 चौकठ *chaukath*, 1250.
 चौक नारन *chauk nāran*, 33.
 चौका *chauka*, 549, 1247, 1426.
 चौकी *chauki*, 30, 35, 36, 389, 457, 629, 635, 765, 830, 1378.
 चौकी *chaunki*, 30, 35.
 चौकी घुमाएब *chauki ghumāēb*, 830.
 चौकीदार *chaukidār*, 1200.

चौकीदारी *chaukidāri*, 1200.
 चौकर *chauker*, 828.
 चौकोर *chaukor*, 1260.
 चौखर *chaukhar*, 1097.
 चौखरिया *chaukharīya*, 1097.
 चौखार *chaukhār*, 821.
 चौगेठ *chaugeth*, 828.
 चौठ *chauth*, 1091, 1201.
 चौठी *chauthi*, 1088.
 चौड *chaur*, 1117.
 चौथी *chauthi*, 1381, 1391.
 चौथी के जोड़ा *chauthi ke jora*, 1381.
 चौंधा *chaundha*, 646.
 चौधार *chauthār*, 1260.
 चौपड़ *chaupar*, 833.
 चौपत *chaupat*, 363.
 चौपहल *chaupahal*, 1260.
 चौपार *chaupār*, 1245.
 चौपी *chaupī*, 713.
 चौभर *chaubhar*, 1095.
 चौमास *chaumāś*, 798, 803, 858, 1006.
 चौमाँस *chaumāns*, 818.
 चौमाँस जोतब *chaumāns jotab*, 818.
 चौमुख *chāumukh*, 833, 1307, 1329, 1374.
 चौर *chaur*, 77.
 चौर *chaur*, 784, 790, 920c.
 चौरठ *chaurath*, 1272.
 चौरत्ती *chauratti*, 1499.
 चौरस रेतनी *chauras retī*, 403.
 चौरा *chaura*, 748, 775.
 चौरौ *chaurī*, 1272.

॥ छ ॥ *chh* ॥

छकण्डा *chhakra*, 147, 150, 164, 199, 201, 202, 203, 204, 205, 208, 211, 212, 214, 218, 1118.
 छकण्डी *chhakri*, 1118.

छकनी *chhakni*, 654.
 छकुनी *chhakuni*, 103.
 छकड़ *chhakkar*, 1118.
 छगन्ना *chhagga*, 969.
 छगन्नाएब *chhagrāēb*, 1115.

- चगरी *chhagri*, 1121.
 चगोटिया *chhagotiya*, 639.
 चहार *chhachhāi*, 1349.
 चँहिया *chhanchhiya*, 139.
 चजा *chhaja*, 68.
 चजा *chhajja*, 179.
 चटङ्गी *chhatanki*, 1500.
 चटाँक *chhatānk*, 1497, 1498.
 चटियाणव *chhatiyāeb*, 1098.
 चट्टन *chhattan*, 544.
 चट्ठी *chhatthi*, 1406.
 चठ *chhath*, 1442.
 चठ बरन्त *chhath bart*, 1442.
 चठि *chhathi*, 1406.
 चठियार *chhuthiyār*, 1406.
 चठी *chhathi*, 1405, 1406.
 चड़न्ड़ा *chharra*, 771.
 चड़ा *chhara*, 225.
 चड़ी *chhari*, 585, 654.
 चड़ीदार *chharīdār*, 1450.
 चड़ीला *chharīla*, 468.
 चत *chhat*, 223, 248, 1244.
 चतन्ना *chhatna*, 45.
 चतन्नी *chhatni*, 245.
 चतरी *chhatri*, 213, 223, 245, 649.
 चतिया *chhatiya*, 192.
 चत्ता *chhatta*, 1045, 1244.
 चदाँत *chhadānt*, 1118.
 चदाम *chhadām*, 1497.
 चन *chhan*, 768.
 चनका *chhanka*, 1272.
 चनना *chhanna*, 853.
 चनान *chhanān*, 713.
 चनुआ *chhanua*, 1130, 1165.
 चनुआ दूध *chhanua dūdh*, 1165.
 चनौटा *chhanauta*, 307, 319b, 456, 685, 711.
 चन्द *chhand*, 768.
 चन्ना *channa*, 252, 442.
 चन्धिया *chhanthiya*, 1244.
 चप *chhap*, 1091.
 चपन्टा *chhapta*, 1074.
 चपरबन्द *chhaparband*, 1218.
 चपरधिया *chhaprahiya*, 1486.
 चपरा *chhapra*, 71.
 चपरी *chhapri*, 71, 1244, 1245.
 चपि *chhapi*, 1087.
 चप्पर *chhappar*, 796, 1244.
 चप्पा *chhappa*, 893.
 चबधिया *chhabadhiya*, 639.
 चमासी *chhamāsi*, 1427.
 चया *chhaya*, 1091.
 चरन्की *chharki*, 99, 111, 832.
 चरन्की बाला *chharki bāla*, 832.
 चरन *chharan*, 1246, 1262.
 चररा *chharra*, 1266.
 चराही *chharāhi*, 786.
 चरि *chhari*, 573.
 चरिया *chhariya*, 1244.
 चलकट्टर *chhalkatūi*, 1163.
 चलकी *chhalki*, 531.
 चलकबेला *chhalchhabela*, 1381.
 चलना *chhalna*, 318.
 चलौनी *chhalauṇi*, 126.
 चहा *chhalla*, 126, 132, 473, 769, 937, 1366.
 चहाबखरा *chhallabakhra*, 126.
 चहाेदार *chhaliedār*, 473.
 चवचमी *chhavanni*, 1479.
 चवत्या *chhahattha*, 737.
 चवत्ती *chhahatthi*, 737.
 चाई *chhāi*, 1125.
 चाउनि *chhāuni*, 1244.
 चाउर *chhāur*, 849.
 चाण *chhāe*, 1088.
 चाकन *chhākan*, 654.
 चाकुन *chhākun*, 103.
 चागर *chhāgar*, 1121.
 चाँह *chhānchh*, 799, 138, 1166.

- हाँही *chhānchhi*, 139.
 हाजा *chhāja*, 367.
 हाँटब *chhāntab*, 391, 888.
 हाड़ *chhār*, 356.
 हाड़ा *chhāra*, 1475.
 हाड़ि *chhāri*, 1113.
 हात *chhāt*, 1244, 1250, 1251.
 हाता *chhāta*, 1244.
 हाती के नारी *chhāti ke nāri*, 224.
 हाँद *chhānd*, 105.
 हान *chhān*, 105 (footnote), 110.
 हानन *chhānan*, 801, 918.
 हानो *chhāni*, 853, 1051.
 हान्ह *chhānh*, 1244.
 हान्ही *chhānhi*, 1244.
 हापा *chhāpa*, 534, 569, 871, 1148.
 हाबन *chhāban*, 372, 1246.
 हारन *chhāran*, 1246, 788, 789.
 हारो *chhāro*, 868.
 हाल *chhāl*, 132, 1264.
 हाल के हँटा *chhāl ke hnta*, 1264.
 हालन्टी *chhālṭi*, 1264.
 हाली *chhāli*, 1163.
 हाल्ही *chhālhi*, 1163.
 हावन्नी *chhāwni*, 895.
 हावा *chhāwa*, 1125.
 हाही *chhāhi*, 71.
 हियोली *chhioli*, 1232.
 हिचनिधँ *chhichaniyān*, 915.
 हिकलहिचा *chhichhlahiya*, 788.
 हिटकन *chhitkan*, 103.
 हिटकनी *chhitkani*, 1250.
 हिटकिनी *chhitkini*, 1250.
 हिटकी *chhitki*, 359.
 हिटब *chhitab*, 855.
 हियाद *chhitāi*, 1309, 1332.
 हिति *chhiti*, 23, 99.
 हित्था *chhitua*, 359, 857, 858.
 हित्हा *chhitṭa*, 64, 284, 801, 857, 858.
 हिट्टी *chhitṭi*, 367.
 हितन्ना *chhitna*, 45.
 हितन्नी *chhitni*, 45.
 हिनवा *chhinwa*, 943.
 हितुर *chhinui*, 1163.
 हितुही *chhinuhi*, 1163.
 हिपक्कहा *chhipkatta*, 875.
 हिपन्नी *chhipni*, 56, 439.
 हिपुली *chhipali*, 678.
 हिमन्ड़ी *chhinri*, 994, 1001, 1004.
 हिमोद *chhinodi*, 1183.
 हिरकना *chhirkana*, 915.
 हिरगिरा *chhirhira*, 284.
 हिरिकनी *chhirikni*, 801.
 हिलकी *chhilki*, 531.
 हिलन्नी *chhlini*, 593.
 हिल्लार *chhillāi*, 1349.
 हिल्ला *chhilla*, 1407.
 हिडली *chhili*, 815.
 ही *chhi*, 444.
 हीँटब *chhīntab*, 855.
 हीटा *chhitā*, 39, 43, 1033.
 हीँटा *chhīnta*, 857, 858.
 हीटी *chhīti*, 39, 43, 288.
 हीँड़ी *chhīuri*, 1171.
 हीप *chhīp*, 414, 931, 1010.
 हीपा *chhīpa*, 460, 680.
 हीपी *chhīpi*, 1316.
 हीमर्दि *chhimari*, 994, 1004.
 हीमी *chhimi*, 994, 1001, 1004.
 हीरा *chhīra*, 1074.
 हीरी *chhīri*, 1074.
 हुआ हनना *chhua chhanna*, 853.
 हुआही *chhuachhhi*, 350, 363, 414, 585a, 763.
 हुआही *chhunehhi*, 363.
 हुआन्दर *chhuachhundar*, 585f.
 हुआन्ती *chhutti*, 912, 913, 1192, 1217, 1230.

- छुट्ठा *chhutha*, 1147.
 छुट्ठका *chhutka*, 1402.
 छुट्ठका के कपड़ा *chhutka ke kapra*,
 1402.
 छू *chhu*, 1451.
 छुल *chhūal*, 1458.
 छुआ *chhūa*, 853.
 छूँही *chhūnchhi*, 414.
 छूट *chhūt*, 912.
 छूटल *chhūtal*, 827, 878.
 छूटल खेत *chhūtal khet*, 827.
 छूटल पटल *chhūtal patal*, 878.
 छूरा *chhūra*, 383.
 छूरी *chhūri*, 388, 470, 474, 583.
 छूहा *chhūha*, 853.
 छूही *chhūhi*, 853.
 छेकनिहार *chheknihar*, 871.
 छेकहरी *chhenkahri*, 1288.
 छेकहरू *chhenkahru*, 1288.
 छेकाइ *chhenkai*, 1335, 1352.
 छेकौनी *chheñkauni*, 1335.
 छेजनी *chhejni*, 865, 866.
 छेवणा *chherua*, 1112, 1121.
 छेवकन *chheukan*, 1272.
 छेवकना *chhevankna*, 1272.
 छेवका *chhevcka*, 1007.
 छेवनी *chhevni*, 576.
 छेवनो *chhevno*, 576.
 छेवणा *chheua*, 1022.
 छेकन *chhekan*, 323.
 छेका *chhenka*, 1287, 1288.
 छेजल *chhejal*, 865.
 छेड़ी *chhenri*, 1074, 1173.
 छेद *chhed*, 156, 604.
 छेना *chhena*, 1163, 1272.
 छेना बाड़ा *chhena bāra*, 1272.
 छेनी *chheni*, 284, 413, 521, 557,
 560, 624.
 छेमी *chhemi*, 994, 996, 1001.
 छेर *chher*, 954, 1121.
 छेरी *chheri*, 1116, 1121.
 छेवन *chhewan*, 576.
 छेवव *chhewab*, 379.
 छेवर *chhehar*, 858.
 छेँटा *chainta*, 44, 318.
 छेँटी *chhainti*, 43, 288, 369.
 छोटकी *chhotki*, 1276.
 छोपनी *chhopni*, 97, 1024.
 छोरणा *chhorna*, 1010.
 छोरौणा *chhorauna*, 1250.
 छोलनी *chholni*, 319h, 456, 555.
 छोलवा *chholwa*, 292.
 छोषा *chhoa*, 1014.
 छोड *chhot*, 1217.
 छोड लोग *chhot log*, 1217.
 छोडि *chhoti*, 566.
 छोडि चकुरी *chhoti akuri*, 566.
 छोडि बेधवारी *chhoti bedhwari*, 566.
 छोड़ *chhonr*, 83, 505.
 छोड़ *chhonrh*, 83, 696, 713.
 छोड़ी *chhorhi*, 144.
 छोड़ी *chhorhi*, 713.
 छोनी *chhoni*, 270.
 छोपा *chhopa*, 48.
 छोपी *chhopi*, 48.
 छोरा *chhor*, 116, 930.
 छोरी *chhori*, 115, 116, 930, 1457.
 छोखल *chholal*, 873.
 छोनिहार *chhaunihar*, 1244.
 छो *chhau*, 1084.
 छोँकल *chhaunkal*, 1272.
 छोँका *chhaunka*, 1272.
 छोँकी *chhaunki*, 963, 1272.
 छोना *chhauna*, 1125.
 छोनी *chhauni*, 576, 1128, 1214,
 1245, 1246.
 छोराट *chhaurāth*, 849.
 छोरो *chhauro*, 849.

॥ ज j ॥

जरे *jai*, 758, 768, 961, 962.

जकेरार *jakerāi*, 959, 1183.

जखाड़ *jakhār*, 775.

जग *jag*, 1459.

जगडोरी *jagdori*, 33.

जगन *jagat*, 939.

जगद्धा *jagdamma*, 1175, 1456.

जगन्मथिया *jaurnathiya*, 972.

जंगला *jangla*, 939, 1075.

जंगली बावग *jangli bāwag*, 858.

जग्वरिया *jagwariya*, 870.

जग्वारी *jagwāri*, 870.

जगह *jagah*, 1234.

जंघिया *janghiya*, 464, 609, 727, 1328.

जंघिया बैसाच *janghiya baisāch*, 1328.

जङ्गल *jangul*, 813.

जङ्गी *jangi*, 585d.

जङ्गी बान *jangi bān*, 585d.

जङ्घा *jangha*, 252, 431, 464, 605, 609.

जचवेया *jachwēya*, 1484.

जचा *jachcha*, 1398.

जचा खाना *jachcha khāna*, 1398.

जजाती *jajāti*, 913.

जजाती बटाइ *jajāti batāi*, 913.

जटहा *jataha*, 1111.

जटहावा *jathāwa*, 1111.

जटा मसी *jata masi*, 468.

जटो *jato*, 1111.

जटहन *jathhan*, 805.

जड़ *jar*, 362a, 1010.

जड़ खर *jar khar*, 1010.

जड़बंधना *jarbandhna*, 119.

जड़िया *jariya*, 1010.

जड़ी *jari*, 1010.

जंतकुटा *jantkutta*, 624.

जंतवा *jantwa*, 619.

जतरी *jatri*, 517.

जददी *jaddi*, 1215.

जद्दी *juddi*, 1214.

जान *jan*, 293, 842, 844, 874, 990, 1184.

जानजीर *janjīr*, 198.

जानजीरा *janjīra*, 590.

जानपैचा *janpāincha*, 846:

जानम गँठ *janam genth*, 1331.

जानम गँठि *janam gēthi*, 1357.

जानम पतर *janam patr*, 1343.

जानम पतरी *janam patri*, 1343.

जानमासा *janmāsa*, 1320.

जानमासा *janmāsa*, 1320, 1322, 1326, 1327, 1337, 1338, 1339.

जानजा *janja*, 1431.

जानाना *janāna*, 1254, 1275.

जानाना किता *janāna kita*, 1254.

जानानी धोती *janāni dhoti*, 740.

जानि *jan*, 1088.

जानिका *janika*, 235 (footnote), 394, 604.

जानिह *januha*, 1084.

जानु *janu*, 1113.

जनेउचा *janēua*, 736.

जनेउ *janēu*, 736.

जनेर *janer*, 985.

जनेरा *janera*, 983, 985, 1144.

जनेव *janew*, 736.

जनीर *janaur*, 1186.

जान्त *jant*, 169, 221.

जान्तरी *jantari*, 961.

जान्नी *janūni*, 1275.

जान्नी *janūri*, 386, 517.

जपन्त *japti*, 1231.

जब *jab*, 959, 961, 990, 1084, 1113.

जब केववा *jab kewwa*, 959.

जबददी *jabdi*, 1231.

जब बुट्टा *jab butta*, 959.

जबगरा *jabra*, 77, 85.

- जमकाठ *jamkāth*, 925.
 जमरिया *jamariya*, 956.
 जमवट *jamvat*, 925.
 जमा *jama*, 1463a, 1468, 1472.
 जमाखरन्ध *jamakharch*, 1463d,
 1468c, 1472; Appendix, 16.
 जमाबन्दी *jamābandi*, 1468c, 1472;
 Appendix, 15.
 जमामार *jamāmār*, 1477.
 जमार *jamār*, 1075.
 जमार गड़ार *jamār garār*, 1075.
 जमाल *jamāl*, 1045.
 जमाल खानी *jamāl khāni*, 956.
 जमाल गोटा *jamāl gota*, 1045.
 जमाली *jamālī*, 956.
 जमाव *jamāo*, 1163.
 जमाव दही *jamāo dahi*, 1163.
 जमा वासिल बाकी *jama wāsīl bāki*,
 1468c, 1472.
 जमिदार *jamilār*, 904.
 जमुइ *jamuī*, 1163.
 जमूरा *jomāra*, 404, 411, 517, 385.
 जमूरी *jamūri*, 517.
 जमोट *jamot*, 925.
 जमौवा *jamaua*, 639.
 जम्बूर *jambūr*, 388.
 जम्हार *jamhār*, 1075.
 जम्हूरा *jamhūra*, 404, 411.
 जर *jar*, 1010, 1201, 1210.
 जरई *jarāi*, 862, 982.
 जरकडा *jarkatta*, 875.
 जरखा *jarkha*, 339.
 जरखोर *jurkhor*, 1180.
 जर चौट *jar chauth*, 1201.
 जरखोरनी *jarchhorni*, 875.
 जरखोरा *jarchhora*, 875.
 जरठुथा *jarathua*, 1043.
 जरठुथा तेल *jarathua tel*, 1043.
 जरदोज *jarđoj*, 502.
 जर पेशगी ठीका *jarpeshgi thika*, 1210.
 जरग्राह *jarrāh*, 384.
 जर समन *jar saman*, 1210.
 जरसुधा *jarsudha*, 238.
 जराएब *jarāēb*, 1416.
 जराह *jarāh*, 384.
 जरि *jari*, 115 (footnote), 444.
 जरिया *jarīya*, 370, 1008.
 जरिया के अख *jarīya ke ākh*, 1008.
 जरी *jari*, 798, 1006.
 जरी खेत *jari khet*, 798.
 जरवा *jarua*, 1043.
 जरवा तेल *jarua tel*, 1043.
 जरवा सोरा *jarua sora*, 370.
 जरेँ *jareñ*, 1166.
 जल *jal*, 655, 1091, 1451.
 जलकर *jalkar*, 1232.
 जलकी *jalki*, 789.
 जलखर *jalkhār*, 1268.
 जलखर *jalkhar*, 1145.
 जलखरी *jalkhari*, 41, 650.
 जलखवावा *jalkhāwa*, 1268.
 जलखेराव *jalgherāv*, 1268.
 जलधर *jaldhar*, 923.
 जलधरी *jaldhari*, 697.
 जलपरवाह *jalparwāh*, 1428.
 जलपातर *jalpātar*, 775.
 जलपान *jalpān*, 1268.
 जलमहार *jalamhār*, 233.
 जलवा *jalwa*, 1380, 1384, 1385.
 जलवा देव *jalwa deb*, 1385.
 जलवेया *jalvaiya*, 1458.
 जलखोर *jalthor*, 973.
 जलाला *jalāla*, 939.
 जलसेन *jalāsen*, 1456.
 जलिया *jaliya*, 87.
 जलेबी *jalebi*, 585.
 जलोत्सर्ग *jalotsarg*, 1459.
 जला *jalla*, 647, 650, 1092, 1145.
 जवसधा *jawsadha*, 238.
 जवा *jawa*, 748, 765.

- जवारन *javān*, 1073.
 जवाहार *javākhār*, 1272.
 लवा गोटा *java gota*, 765.
 जँवाय *juñwāy*, 1274.
 जवारा *javāra*, 961.
 जवारी *javāri*, 758.
 जवाम *javās*, 1085.
 जसरिया *jasariya*, 965f.
 जसेर *juser*, 940.
 जसोधा *jasodha*, 238.
 जहड़ *jahar*, 938.
 जहरन्वात *jaharbāt*, 1179.
 जहरन्बाद *jaharbād*, 1179.
 जहेज *jahej*, 1283.
 जादही *jāchhi*, 625.
 जाइठ *jāith*, 346.
 जाइल *jāil*, 860, 1132.
 जाई *jāi*, 833, 1092.
 जाउर *jāur*, 1272.
 जाए *jāē*, 1087, 1088.
 जाप्रब *jāpb*, 1078, 1132, 1173, 1174,
 1486.
 जाञ्जे *jāo*, 1087.
 जाक *jāk*, 893.
 जाकड़ *jākar*, 1480.
 जाकर *jākar*, 1462.
 जागर *jāgar*, 965b.
 जागीर *jāgār*, 1200, 1209b.
 जागीरदार *jaqurdār*, 1200.
 जागे *jāge*, 1026.
 जाँघा *jāngha*, 609, 1328.
 जाँघा बैसाप्रब *jāngha bāisāpb*, 1328.
 जाँच *jānch*, 1485.
 जाँचब *jānchab*, 1484.
 जाँच मिलान *jānch milān*, 1485.
 जाँच लेब *jānch leb*, 1485.
 जाजिम *jājim*, 750.
 जाट *jāt*, 917.
 जाटि *jāti*, 917.
 जाठ *jāth*, 256, 273, 346, 917.
 जाठि *jāthi*, 330, 917.
 जाड़ *jār*, 1092.
 जाड़ा *jāra*, 1083.
 जात *jāt*, 1089.
 जाँत *jānt*, 443, 625, 928.
 जाँता *jānta*, 443, 581, 619.
 जानि *jāti*, 1217.
 जादू *jādu*, 1453.
 जाडूगर *jadūgar*, 1453.
 जान *jān*, 719, 790.
 जानथि *jānthi*, 356.
 जाना *jāna*, 915, 844.
 जानिमाज *jānimāj*, 751.
 जानिहार *jānihar*, 1416.
 जाप माला *jāp māla*, 781.
 जाफरी *jāphri*, 770.
 जाब *jāb*, 94.
 जाबन्ता *jābta*, 1474.
 जाबन्ता साह जोग *jābta sāh jog*, 1474.
 जाबर *jābar*, 1272.
 जाबा *jāba*, 94.
 जाबी *jābi*, 94.
 जाम *jām*, 678.
 जामा *jāma*, 732, 1371, 1379, 1381,
 1382.
 जामुन *jāmun*, 1272.
 जान्हर *jānhar*, 1075.
 जाय *jāy*, 250, 356, 414, 572, 604,
 1084, 1272.
 जाय नैसाज *jāy nēsāj*, 751.
 जाबब *jāwab*, 1416.
 जाल *jāl*, 646, 1094.
 जालदार *jāldār*, 1236.
 जाला *jālu*, 69, 224, 647, 713, 1074,
 1145.
 जाली *jāli*, 87, 94, 646, 650, 748.
 जालीदार *jāldār*, 1236.
 जावर *jāwar*, 1400.
 जाँवर *jāñwar*, 1400.
 जावा *jāwa*, 758, 957.

- जासर *jāsar*, 1037.
 जासू *jāsu*, 1033.
 जाह *jāh*, 790, 1142.
 जिउतिया *jūtiya*, 1447.
 जिकरी *jikri*, 1487.
 जिगरी *jigri*, 1487.
 जिग्गा *jigga*, 757, 768.
 जितिया *jitiya*, 1447.
 जिन *jin*, 1458.
 जिनदाँ *jincañ*, 1075, 1183.
 जिनिस *jinis*, 1470e.
 जिनिसवार *jiniscār*, 1468a.
 जिनोरा *jinora*, 983, 985, 987.
 जिन्दार *jinhār*, 1075.
 जिबदान *jibdān*, 1457.
 जिबिया *jibiya*, 275.
 जिभा *jibha*, 711.
 जिब्ही *jibhi*, 1173.
 जिभसडा *jibhsatta*, 1173.
 जिभिया *jibhiya*, 275.
 जिभेला *jibhela*, 363.
 जिमिदार *jimidār*, 1208.
 जिमिदारी *jimidāri*, 1207.
 जिथता *jiyata*, 649.
 जिथा *jiya*, 1457.
 जिथा दान *jiya dān*, 1457.
 जिरतिहा *jiṛatiha*, 1184.
 जिरान *jiṛāt*, 903, 1040, 1221.
 जिलन्दगर *jildgar*, 586.
 जिलन्दबन्द *jilband*, 586.
 जिलनैया *jilwaiya*, 1458.
 जिलनैया के छुल्ल *jilwaiya ke chhūal*,
 1458.
 जिला *jila*, 539, 1040.
 जिनादार *jilādār*, 1040.
 जिला सान *jilā sān*, 539.
 जिलेबिया *jilebiya*, 473.
 जिलबिया कुलुफौ *jilebiya kulphi*, 473.
 जिलेबी *jilebi*, 1272.
 जिलैया *jilaiya*, 1458.
 जिवगर *jiwgar*, 851, 922.
 जिवगर पानी चाबि गेल *jiwgar pāni
ābi gel*, 922.
 जिवगर चोपला धूर बैसाचोल *jiwgar
hoè la dhūr baisāöl*, 851.
 जिस्ता *jista*, 335h, 706.
 जिहला *jihla*, 363.
 जिहेला *jihela*, 363.
 जीए *jiē*, 1026.
 जीगर *jigar*, 800.
 जीता *jita*, 645.
 जीभा *jibha*, 275.
 जीयत *jiyat*, 645.
 जीयल *jiyal*, 933.
 जीर *jiṛ*, 972, 1073.
 जीरा *jiṛa*, 975, 1073.
 जुआठ *juāth*, 14, 194, 938.
 जुग *jug*, 1023.
 जुगन्डा *jugra*, 1183.
 जुगनु *jugnu*, 765.
 जुजवी *jujwi*, 1208.
 जुजवी चिखेदार *jujwi chikhedār*
 1208.
 जुङ्गुडो *jugguro*, 1183.
 जुइली *jurailin*, 1310.
 जुइलू *jurailu*, 1310.
 जुत्ता *jutta*, 735.
 जुनेरी *juneri*, 121, 122.
 जुन्ना *junna*, 120.
 जुअर *juār*, 193, 938.
 जुआ *juā*, 14, 194, 443, 621, 1391.
 जुग *jug*, 1483.
 जुइ *juṛ*, 1449.
 जुइ सौतल *juṛ sital*, 1449.
 जुइ सितलक सिपाही *juṛ sitalak sipāhi*,
 1449.
 जुता *jūta*, 735.
 जुता गोर लगर *jūta gor lagar*,
 1336.
 जुता चोरार *jūta chorār*, 1336.

जूना *jūna*, 735.
 जूना *jūna*, 96, 120, 122.
 जूर *jūr*, 1183.
 जूही *jūhi*, 585.
 जकन्ना *jekra*, 1020.
 जटन्स *jethans*, 1214.
 जठकी *jethki*, 1276.
 जठरी *jethri*, 1276.
 जठरैयत *jeth raiyat*, 1217.
 जठरन्स *jethhans*, 1214.
 जठुथा *jethua*, 879, 1021, 1228.
 जठौठी *jethauti*, 1214.
 जठौनी *jethauti*, 1214.
 जेवन्नार *jeonār*, 1345, 1426.
 जेवारन *jewān*, 1073.
 जेवार्न *jevān*, 1402.
 जे *je*, 967, 1025, 1085, 1087, 1091,
 1092.
 जेकर *jekar*, 1086.
 जेठ *jeth*, 1082, 1092.
 जेठी *jethi*, 985.
 जेड़ *jer*, 1124.
 जेव *jev*, 77.
 जेरन्पार *jevpār*, 735.
 जेरन्बन्ध *jevband*, 226.
 जेल् *jel*, 1124.
 जेम् *jemu*, 966.
 जेवर *jevvar*, 115, 398, 415.
 जेश्ठा *jeshtha*, 1082.
 जेदादी *jeḍādi*, 1224.
 जै *jai*, 962.
 जैती *jainti*, 961.
 जैतुक *jaituk*, 1283.
 जैत्री *jaintri*, 517.
 जैबों *jaibon*, 1087.
 जैयद *jaiyad*, 800.
 जैया मिरन्चा *jaiya mircha*, 1073.
 जोकन्टी *jokti*, 1171.
 जोगनियँ *joganīyān*, 870.
 जोगाप्रब *jogāeb*, 870.

जोड़ाप्रब *joṛāeb*, 1404.
 जोतिह *jotiha*, 829.
 जोधरिया *jondhariya*, 987.
 जोधरी *jondhri*, 985.
 जोन्हरी *jonhri*, 985.
 जोन्धिया *jonhiya*, 155.
 जोरन्वा *joṛwa*, 378.
 जोलन्चा *jolha*, 355, 356, 990.
 जोलन्दिनी *jollini*, 356.
 जोलाचा *jolāha*, 355, 356.
 जोसाँदा *josānda*, 933.
 जो *jo*, 959, 961.
 जोँ *jon*, 1084, 1087, 1090.
 जोँका *jonka*, 13, 233, 1011.
 जोँकी *jonki*, 13, 1171.
 जो खंसरा *jo khesra*, 959.
 जोग *jog*, 1343, 1474, 1457, 1487.
 जोग टोन *jog ton*, 1457.
 जोग मिलाब *jog milab*, 1343.
 जोग मिलाप्रब *jog milāeb*, 1343.
 जोंगा *jonga*, 967c, 970.
 जोगी *jogi*, 782, 1092.
 जोठ *joth*, 938.
 जोड़ *joṛ*, 1331.
 जोड़ा *joṛa*, 625, 735, 1096, 1381.
 जोड़ी *joṛi*, 149, 451, 941, 1096.
 जोही *joṛhi*, 1129.
 जोत *jot*, 226, 825, 828, 1009.
 जोतब *jotab*, 817, 818, 1098.
 जोतल *jotal*, 817, 1098.
 जोता *jōta*, 18, 116, 196, 642, 818,
 930.
 जोता बावग *jōta bāvag*, 818.
 जोती *jōti*, 18, 120, 145, 196, 116,
 117, 398, 415, 470, 642, 645, 930.
 जोन्ही *jonhi*, 155.
 जोब *job*, 1183.
 जो बुहा *jo butta*, 959.
 जोर *joṛ*, 108, 110, 115, 1088.
 जोरन *joṛan*, 1162.

जोरा *jora*, 128, 1145.
 जोरु *joru*, 1275.
 जोरो *joro*, 110.
 जोरा *joha*, 270.
 जोहररी बरन्म *jauhri barm*, 1456.
 जो *jau*, 356, 444, 959, 960, 961,
 1000, 1089, 1504.
 जोँ *jauñ*, 1084, 1087, 1088.
 जो केरार *jau kerāi*, 959, 960, 1000,
 1183.

जोगा *jauga*, 969.
 जोली *jauji*, 1275.
 जोँदा *jaunrha*, 184.
 जो मटरा *jau matra*, 959.
 जोरा *jaura*, 1194, 1204.
 जोरी *jauri*, 115, 120.
 जोसन *jausan*, 767.
 जोँ *jyon*, 568, 737.

॥ अ ज ॥

अकना *jhakna*, 84.
 अकाप्रब *jhakāēb*, 876.
 अखुरी *jhakhuri*, 815.
 अखुली *jhakhuli*, 815.
 अगार *jhaggār*, 935.
 अङ्गा *jhanga*, 896.
 अङ्गार *jhajjhar*, 713.
 अङ्गारा *ghanjhara*, 307, 319b, 456,
 685.
 अङ्गिया *ghanjiya*, 835.
 अटका *jhataka*, 184, 190, 191, 205,
 224.
 अटनी *jhantni*, 887.
 अटहा *jhatha*, 41.
 अटाहब *jhatahab*, 876.
 अट्या *jhata*, 894.
 अटै *jhatai*, 55.
 अटैनी *jhataini*, 57.
 अटुया *jharna*, 53.
 अनाक *ghanak*, 1174.
 अनकट *ghankat*, 1251.
 अनकवाता *ghanakbāta*, 1174.
 अनकवाह *ghanakwāh*, 1174.
 अनका *ghanka*, 1174.
 अनकौट *ghankaut*, 1250.
 अपट *ghapat*, 655.
 अपना *ghapna*, 79, 562.
 अपान *ghapān*, 957.

अँपिया *jhampiya*, 45.
 अबरा *jhabra*, 1110.
 अबन्ही *jhabhi*, 136, 713.
 अबिया *jhabiya*, 767, 770.
 अब्या *jhabba*, 770.
 अब्बू *jhabbu*, 100.
 अमन्दी *ghamri*, 995.
 अर *ghar*, 878, 980, 1075.
 अरकण्ठी *gharkanti*, 815.
 अरका *gharka*, 679, 1074.
 अरखाप्रब *gharkhāēb*, 876.
 अरंगा *gharnga*, 967f.
 अरंगा *gharnga*, 878, 1075.
 अरङ्गराप्रल *gharjharāēl*, 876.
 अरणा *gharna*, 57, 401, 440, 456,
 606, 685, 711.
 अरणा रन्दा *gharna randa*, 401.
 अरनी *gharni*, 428, 747.
 अरहा *gharha*, 815.
 अरी *ghari*, 1088.
 अर्या *gharna*, 878, 1183.
 अलमरन्दन *ghalmardan*, 965d.
 अलरिया *ghalariya*, 985.
 अलसी *ghalsi*, 121.
 अलास *ghalās*, 121, 815, 1131.
 अँकब *ghānkab*, 1405.
 अँखी *ghānkhī*, 57.
 अँग *ghāng*, 896, 995.

- भौंभ *jhānjh*, 685, 776.
 भौंभा *jhānjha*, 1272.
 भौंठब *jhāntab*, 887.
 भौंटा *jhānta*, 57.
 भौंटी *jhānti*, 815.
 भाड़ भड़ *jhār jhūr*, 1446.
 भाड़नी *jhārni*, 866.
 भाड़ुचा *jhārūa*, 53.
 भाड़ू *jhāru*, 53, 57, 465.
 भाँप *jhāmp*, 45, 50, 467, 554.
 भाँपन *jhāmpan*, 554.
 भाँपना *jhāmpna*, 554.
 भाँपा *jhāmpa*, 45.
 भाँपी *jhāmpi*, 45, 657.
 भाबर *jhābar*, 1110.
 भाभ *jhām*, 27, 602, 1264.
 भाभा *jhāma*, 27, 591, 1264.
 भाभो *jhāmo*, 1264.
 भाार *jhār*, 815, 655, 995, 1075, 1183, 1250.
 भाारंग *jhārang*, 878.
 भाारङ्ग *jhārang*, 1075.
 भाारन *jhāran*, 930.
 भाारब *jhārab*, 58, 887.
 भाारा *jhāra*, 815.
 भाारि *jhāri*, 58.
 भाारि सुरि देब *jhāri jhūri deb*, 58.
 भाारी *jhāri*, 432, 688, 689, 713.
 भाारी के रन्दा *jhāri ke randa*, 402.
 भाार *jhāru*, 56.
 भाारू *jhāru*, 439.
 भााल *jhāl*, 776.
 भाालर *jhālar*, 590.
 भााला *jhāla*, 1024.
 भाावन *jhāvan*, 1477.
 भााँवाँ *jhāwāwā*, 1264.
 भिकगटा *jhikta*, 793.
 भिकगटिया *jhiktiya*, 793.
 भिकगटी *jhikti*, 793, 794, 1262.
 भिकगटौर *jhiktaur*, 793.
 भिकगडा *jhikra*, 793.
 भिकगड़ी *jhikri*, 1262.
 भिकगरौर *jhikraur*, 793.
 भिँगुनी *jhinguni*, 1069.
 भिँगुली *jhinguli*, 1069.
 भिङ्गा *jhinga*, 1069.
 भिड़की *jhituki*, 1262.
 भिड़ी *jhitti*, 99, 149, 196, 1096.
 भिमङ्की *jhimki*, 742, 745.
 भिमङ्किसिया *jhimjhisiya*, 764.
 भिरग्या *jhirgya*, 1075.
 भिरुचा *jhirua*, 1075.
 भिरौचा *jhiruaa*, 1075.
 भिनिया *jhiliya*, 1272.
 भिळी *jhilli*, 1074, 1272.
 भौँक *jhūnk*, 622.
 भौँका *jhūka*, 622.
 भौँका *jhūka*, 622.
 भौँरो *jhūro*, 1075, 1183.
 भौँल *jhūl*, 790.
 झुकन्ता *jhukta*, 645.
 झुटकाँ *jhutka*, 1262.
 झुटकी *jhutki*, 1262.
 झुण्ड *jhund*, 1124.
 झुनङ्की बीर *jhunki bir*, 1456.
 झुमङ्क *jhummak*, 764.
 झुरङ्गी *jhurni*, 866.
 झुरि *jhuri*, 58.
 झुलङ्गी *jhulni*, 763.
 झूड़ *jhūr*, 1446.
 झूड़ *jhūr*, 1124.
 झूमक *jhūmak*, 764.
 झूर *jhūr*, 815.
 झूल *jhūl*, 133, 1431.
 झूला *jhūla*, 744.
 झूस *jhūs*, 799.
 झूसी *jhūsi*, 799.
 झेगटा *jhagta*, 896.
 झेगडा *jhengra*, 937.
 झेगरा *jhengra*, 896, 995.

भोंगी *jhengi*, 973.
 भोंकरल *jhonkral*, 1080.
 भोंपन्दा *jhomptra*, 879, 1234.
 भोंपन्डी *jhompri*, 71, 879, 1234.
 भोलारल *holäil*, 1080.
 भोंक *jhonk*, 196.
 भोंभन *jhonjhan*, 1258.

भोर *jhor*, 789, 832, 1001, 1272.
 भोरल *jhoral*, 876.
 भोरा *jhora*, 41, 734, 781, 647, 832
 भोरी *jhori*, 507, 647.
 भोल *jhol*, 1116.
 भोला *jhola*, 41, 133, 134, 647, 1080
 भोली *jholi*, 133, 134, 647.

॥ ट t ॥

टकना *takna*, 482.
 टकमाल *taksal*, 1488.
 टकन्धी *takhi*, 1198, 1479.
 टका *taka*, 1479, 1497.
 टकुचा *takua*, 350, 499, 518.
 टकौरी *takauri*, 462, 640.
 टक्का *takka*, 1500.
 टंगना *tangna*, 649.
 टंगनी *tangni*, 364, 613, 619.
 टंग्बह *tangbah*, 363.
 टंगारी *tangāri*, 86.
 टंगारी *tangāri*, 395.
 टंगुनी *tangunī*, 988
 टंगौर *taingaur*, 49, 895.
 टङ्गा *tanga*, 395.
 टटघर *tatghar*, 1234.
 टटुचानौ *tatuāni*, 1126.
 टटौघर *tataughar*, 1235.
 टट्टी *tatti*, 381, 585, 1051,
 1250.
 टट्टी लीलुफर *tatti lilu phar*, 585.
 टट्टू *tattu*, 1126.
 टंङ्गना *tanrna*, 276.
 टंङ्गचा *tanrua*, 792, 954.
 टपन्का *tapka*, 1246.
 टपन्का मारब *tapka mārūb*, 1246.
 टप्पर *tappar*, 319m.
 टरन्वाह *tarwāh*, 857.
 टरन्सूरी *tarsūi*, 24.
 टरिया *tariya*, 713, 767.

टलन्हा *talha*, 161.
 टलाह *talāh*, 161.
 टलुचा *talua*, 161.
 टहन्ना *tahra*, 1125.
 टहन्नी *tahri*, 136.
 टाँक *tānk*, 372.
 टाकर *tākar*, 793.
 टाका *tāka*, 1113.
 टाँगव *tāngub*, 624, 1422.
 टाँगह *tāngah*, 363.
 टाँग *tānga*, 224, 395.
 टाँगी *tāngi*, 395.
 टाँगुन *tāngun*, 988.
 टाट *tāt*, 129, 319, 1051, 1486.
 टाटी *tāti*, 1051, 1084, 1234, 1250,
 1416.
 टाँठी *tānhi*, 682.
 टाड़ *tār*, 713, 784.
 टाँड़ *tānr*, 784, 788, 790, 857.
 टाड़ा *tāra*, 713, 1011, 1074.
 टाँड़ा *tānra*, 1074.
 टाड़ी *tāri*, 713.
 टाँड़ी *tānri*, 24, 328, 784, 1074.
 टाप *tāp*, 48, 50, 646.
 टापा *tāpa*, 48, 50.
 टापौ *tāpi*, 48, 50, 646.
 टार *tār*, 24, 767, 857.
 टाँर *tānr*, 857.
 टारब *tārab*, 857.
 टारी *tāri*, 857.

- टाल *tāl*, 161, 784, 853, 890, 894,
 986.
 टाली *tāli*, 1263.
 टिकन्ठी *tikthi*, 318, 1416.
 टिकन्ठी के लकड़ी *tikthi ke lakri*,
 226.
 टिकरी *tikri*, 466, 1272.
 टिकिया *tikiya*, 1272.
 टिकुला *tikula*, 1272.
 टिकुली *tikuli*, 747, 762.
 टिकोहा *tikorha*, 1272, 1449.
 टिकोर *tikor*, 793.
 टिकर *tikkar*, 791, 793.
 टिकन्ठी *tikthi*, 567.
 टिपन्कारि *tipkari*, 1246.
 टिपन्दार *tipdār*, 1208, 1217.
 टिपन्ना *tipna*, 480.
 टिपन्नी *tipni*, 867.
 टिपुनी *tipuni*, 482.
 टिब्ही *tibhi*, 1009.
 टिभिया *tibhiya*, 987.
 टिररी *tirri*, 1074.
 टिल्हा *tilha*, 791, 793.
 टिल्हा टाकर *tilha tākar*, 793.
 टीक *tik*, 69.
 टीकब *tikab*, 240.
 टीका *tika*, 1400.
 टीड़ी *tiri*, 1074.
 टीनी *tini*, 1183.
 टीपन *tipan*, 1343.
 टीपुर *tipur*, 793.
 तुँया *tuñiya*, 713.
 तुकरी *tukri*, 1272.
 तुंगना *tungna*, 958.
 तुंगनी *tungni*, 875.
 तुटाह *tutāh*, 1094.
 तुनकी *tunki*, 1074, 1177.
 तुणौ *tuān*, 713.
 तुँ *tūn*, 713.
 टूक *tūk*, 723.
 टूका *tūka*, 1272.
 टूंगब *tūngab*, 624.
 टूट *tūt*, 922, 1094.
 टूट गैल *tūt gail*, 1094.
 टूटन *tūtan*, 1265.
 टूँ *tūn*, 958, 961.
 टूँडा *tūnda*, 961, 958.
 टूसल *tūsāl*, 604.
 टेकन्ठी *tekthi*, 318.
 टेकन्नी *tekni*, 464.
 टेकानी *tekāni*, 167, 169, 173, 174,
 175, 176, 179, 182, 184, 189,
 200, 203, 221, 222, 464.
 टेकुचा *tekua*, 350, 499, 518, 589.
 टेकुरी *tekuri*, 518.
 टेकुली *tekuli*, 518.
 टेकौरी *thekauri*, 462.
 टेखन्नी *tekhti*, 461, 508.
 टेखन्धी *telkhi*, 226.
 टेँदुचा *teñrua*, 243.
 टेपन्टा *tepta*, 842, 1097.
 टेपाइ *tepāi*, 319j.
 टेबचा *terua*, 243, 1252, 1256, 1257.
 टेहरा *tehra*, 713.
 टेहरी *tehri*, 136.
 टेहान *tehān*, 1120.
 टेँट *teñt*, 726.
 टेनी *teni*, 1011.
 टेँभी *teñbhi*, 957.
 टेमा *tema*, 96.
 टेर *ter*, 1017, 1110, 1113.
 टोकन्डा *tokra*, 44.
 टोकन्डी *tokri*, 44, 49, 369, 895.
 टोकन्दार *tokdār*, 1040.
 टोकन्ना *tokna*, 669.
 टोकन्नी *tokni*, 97, 261, 867.
 टोका *tolka*, 69, 1457.
 टोटन्मा *totma*, 69, 1457.
 टोटन्म *totram*, 1457.
 टोटन्वाँ *totwān*, 69.

टौँटिया *tonliya*, 713.
 टौँटियारी *tonliyāri*, 1262.
 टौँडिया *toriya*, 1265.
 टोनकट *tonkat*, 286.
 टोनकट्टा *tonkatta*, 286, 293.
 टोनख्खाद् *tonkhād*, 281, 298, 1008.
 टोनख्खावा *tonkhāwa*, 1008.
 टोनिकट्टा *tonikattu*, 293.
 टोनियाठी *toniyāthi*, 281.
 टोनियारी *toniyāri*, 281, 298.
 टोनियासी *toniyāsi*, 281, 298.
 टोपन्ना *topna*, 413.
 टोपन्ना *topra*, 832, 838.
 टोपन्नी *topri*, 832.
 टोरन्वाह *torwāh*, 857.
 टोदया *toiya*, 1246.
 टोक *tok*, 1040.
 टोकब *tokab*, 866, 867.

टौँटा *tonṭa*, 1010.
 टौँटी *tonṭi*, 688, 1262.
 टोड़ *tor*, 918.
 टौँड़ *tour*, 857.
 टोड़ा *tora*, 768.
 टोन *ton*, 1457.
 टोना *tona*, 69, 933, 940, 100-
 1457.
 टोनी *toni*, 288, 1008.
 टोपड़ *topar*, 895.
 टोपन *topan*, 413.
 टोपी *topi*, 398, 725.
 टोर *tor*, 9, 24, 857.
 टौर *tour*, 857.
 टोर लागप्रब *tor lagāēb*, 857.
 टोरा *tōra*, 9.
 टोरी *tori*, 857.
 टोह *toha*, 1045.

॥ ठ th ॥

ठकर *thakar*, 106.
 ठकरा *thakra*, 68.
 ठकरी *thakri*, 747.
 ठकवा *thakwa*, 464.
 ठकखरिया *thakhariya*, 837.
 ठकुआ *thakua*, 1272.
 ठग *thag*, 1486.
 ठटर *thatur*, 1250.
 ठटरा *thatra*, 1051.
 ठठरी *thatri*, 213, 245, 247, 318,
 649.
 ठठरी *thathri*, 1051.
 ठठेर *thather*, 986.
 ठठेरा *thathera*, 548, 983, 986.
 ठठेरी *thatheri*, 548, 558.
 ठठेरो *thathero*, 896, 983, 987.
 ठठ्ठाना *tharbāta*, 233.
 ठठिया *thariya*, 473.

ठठारँ *tharhāñ*, 828.
 ठठिया *tharhiya*, 828, 1033, 1073,
 1183, 233, 473.
 ठठ्या *thappa*, 533, 569, 590.
 ठठमरा *thamra*, 1158.
 ठठन्पचनरा *tharpachra*, 251.
 ठठररा *tharra*, 123, 858.
 ठठरिया *thariya*, 1033.
 ठठस *thas*, 800.
 ठठसा *thasa*, 533.
 ठठसा *thassa*, 533.
 ठठहार *thahar*, 1247.
 ठठहरा *thahra*, 1114.
 ठठारँठ *thāñth*, 1158.
 ठठारँठ जोप्रब *thāñth joēb*, 1158.
 ठठकुर *thakur*, 383, 407, 975, 1208.
 ठठकुर भोग *thakur bhog*, 975.
 ठठठ *thāt*, 585, 1244, 1245.

- ठाँठी *thanthi*, 682.
 ठार *thār*, 26.
 ठारहा *thārha*, 26.
 ठामे *thāme*, 115 (footnote).
 ठारिक *thārik*, 834.
 ठाँव *thāme*, 747, 1247.
 ठाँस *thāns*, 534.
 ठासा *thāsa*, 534.
 ठिकन्डा *thikra*, 511, 793.
 ठिकड़िया *thikariya*, 1263.
 ठिकन्ना *thikra*, 563.
 ठिकन्नाहू *thikrahū*, 793.
 ठिकरिया *thikariya*, 793.
 ठिकरी *thikri*, 1262.
 ठिकन्नाल *thikraul*, 793.
 ठिकर *thikkar*, 563.
 ठिंगुरियाग्रल *thinguriyāēl*, 1076.
 ठिया *thiya*, 404, 408.
 ठिलिया *thiliya*, 432, 713.
 ठिहा *thiha*, 404.
 ठीकर *thīkar*, 793.
 ठीका *thika*, 1040, 1210.
 ठीका के लील *thika ke lil*, 1040.
 ठीकेदार *thikedār*, 1210.
 ठीकेदारी *thikedāri*, 1210.
 ठीचा *thīncha*, 45.
 ठीचा *thīha*, 404, 408.
 ठुडा *thuttha*, 987.
 ठुण्ठा *thuntha*, 987.
 ठुनका *thunka*, 385.
 ठुरी *thurri*, 1272.
 ठुरियाग्रल *thuriyāēl*, 1076.
 ठूठा *thūtha*, 1107.
 ठूरी *thūri*, 1272.
 ठेका *theika*, 953.
 ठेकनी *thekni*, 464.
 ठेकरा *thekrā*, 106, 612.
 ठेकवा *thekwa*, 89, 464.
 ठेकुचा *thekua*, 1272.
 ठेकुरी *thekuri*, 1250.
 ठेंगना *thengna*, 464.
 ठेंगनी *thengni*, 654.
 ठेंगुनी *thenguni*, 654.
 ठेंगुरी *thenguri*, 654.
 ठेंगनी *thenghni*, 362.
 ठेंगुनी *thenghuni*, 654.
 ठेंठिवाल *thenthivāl*, 319.
 ठेंठिवाल नाद *thenthivāl nād*, 319.
 ठेवका *thevka*, 952.
 ठेहररी *thehri*, 236.
 ठेञ्चा *thehca*, 389.
 ठेऊना *thekuna*, 1010.
 ठेऊन *thekun*, 1159.
 ठेक *thek*, 77, 764.
 ठेकर *thekar*, 106.
 ठेका *theka*, 108, 464.
 ठेकी *theki*, 401.
 ठेकुर *thekur*, 106.
 ठेंग *theng*, 654.
 ठेंगा *thenga*, 654.
 ठेंगी *thengi*, 654.
 ठेंठा *thentha*, 2, 825.
 ठेंठा के जोत *thentha ke jot*, 825.
 ठेंठी *thenthi*, 2, 29.
 ठेंठी कोदार *thenthi kodār*, 28.
 ठेपी *thepi*, 401, 81.
 ठेल *thel*, 236.
 ठेहा *thaha*, 91, 325, 286, 404, 408, 527, 1141.
 ठेचा *thaicha*, 45.
 ठेंचा *thaincha*, 45.
 ठोकना *thokna*, 600.
 ठोकन्ना *thokra*, 106, 1075.
 ठोंठियारी *thonthiyāri*, 1074.
 ठोपारी *thopāri*, 1015.
 ठोकब *thokab*, 853, 1484.
 ठोकर *thokar*, 106.
 ठोकल *thokal*, 853.
 ठोरी *thori*, 1272.
 ठोंसा *thonsa*, 534.

॥ ड d ॥

- दगर *dagar*, 941.
 दगनन *dagran*, 106.
 दगरना *dagarna*, 459.
 दगना *dagra*, 44, 47, 608, 714.
 दगरिन *dagrin*, 1400.
 दगरी *āgrī*, 44.
 दंगौनी *daṅgauni*, 887.
 दग्गी *daggi*, 1130.
 दङ्गा *danga*, 996
 दघनाप्रब *daghrāb*, 1098.
 दंटकी *dantki*, 1024.
 दंटुका *dantuka*, 896.
 दटौका *dtauika*, 654.
 दंडुवाँस *danwāns*, 375.
 दंडिया *danriya*, 154, 225, 247.
 दंडेर *danrer*, 833.
 दंडेरु *danrera*, 225.
 दंडेरु *danreri*, 919.
 दंडेरु *darenri*, 225.
 ददुषा *darhua*, 1043.
 ददुषा तेल *darhua tel*, 1043.
 दंदेरी *danrheri*, 188.
 दण्डा *danta*, 191, 213, 223, 236,
 247, 335a, 414, 431, 508, 510,
 654.
 दण्डी *danti*, 60, 415, 455, 335a, 888,
 1024, 1315.
 दण्डी दाँवब *danti dāwab*, 888.
 दण्ड कामण्डल *dand kamandal*, 782.
 दण्डा *danda*, 213, 223, 235, 414,
 416, 611, 931, 940, 1250.
 दण्डी *dandi*, 415, 508, 598, 644.
 दपण्टन *daptan*, 306, 457.
 दपण्टी *dapti*, 305.
 दफाली *daphālī*, 1456.
 दबरी *dabri*, 713.
 दबल *dabal*, 1000.
 दबल केराब *dabal kerāb*, 1000.
 दबन्ही *dabhi*, 137.
 दब्बु *dabbu*, 319 g & l, 305, 43
 450, 458.
 दब्बु *dabbu*, 683, 711.
 दभन्कल *dabhkal*, 1272.
 दभन्का *dabhka*, 1272.
 दभन्को *dabhko*, 1066.
 दभन्को *damko*, 68.
 दभन्कौला *damkaula*, 68.
 दभरन्डाक *damardak*, 1456.
 दमार *damār*, 848, 852.
 दमारा *damāra*, 848, 852.
 दमन्हीचा *damhaua*, 68.
 दम्फ *damp*, 29.
 दम्हरो *damharo*, 1075.
 दर *dar*, 1075.
 दंरन्कस *danrkas*, 376.
 दलन्भाकना *dajhakna*, 1381.
 दलन्नी *dalni*, 641.
 दलिया *daliya*, 44, 284, 412.
 दहना *dahra*, 1125.
 दहनाप्रब *dahrāb*, 1098.
 दहरी *dahri*, 1125.
 दाद *dāi*, 417.
 दारन *dāin*, 1453.
 दाक *dāk*, 1084, 1085, 1088, 1456.
 दाकनी *dākni*, 156.
 दाकिनी *dakini*, 1088.
 दाँग *dāng*, 103, 654.
 दाँगर *dāngar*, 1094, 1183.
 दाँट *dānt*, 880, 896, 983, 987, 990,
 1024, 1183.
 दाँटा *dānta*, 896.
 दाँटी *dānti*, 896, 983, 987, 990,
 1483.
 दाँठ *dānth*, 880, 896, 990, 995,
 1024.
 दाँड *dānr*, 237, 792, 833, 954, 1010

- डाँडर *dānra*, 198.
 डाँडा *dānra*, 376.
 डाँडी *dāuri*, 75, 60, 247, 335a.
 दाही *dārhi*, 1037, 1161.
 दाबर *dābar*, 792, 832.
 दाबा *dāba*, 137, 713.
 दाभा *dābha*, 450.
 दाभी *dābhi*, 815, 957, 1001, 1075, 1183.
 दाम *dām*, 1066.
 दारब *dārab*, 1350.
 दाल *dāl*, 1347.
 दाल दौरा *dāl daura*, 1347.
 दाला *dāla*, 44, 325, 1347.
 दाली *dāli*, 44, 45, 1194.
 दाँस *dāns*, 415.
 दाँसन *dānsan*, 390.
 दाही *dāhi*, 726 (footnote), 868.
 दिवौरी *dithauri*, 1045.
 दिड़िया *diriya*, 1073.
 दिड़िया मिरन्चाइ *diriya mirchāi*, 1073.
 दिँडोर *dinror*, 66.
 दिन्दी *dindi*, 994, 1001, 1004, 1017, 1029.
 दिण्डी लागल है *dindi lāgal hai*, 1001.
 दिफौ *diphi*, 1009.
 दिबरा *dibra*, 563.
 दिबरी *dibri*, 713.
 दिबिया *dibiya*, 535, 658.
 दिब्बा *dibba*, 658.
 दिब्बी *dibbhi*, 957, 986, 994, 1001, 1018.
 दिभा *dilla*, 793.
 दिधी *dilli*, 478.
 दिसनिल *dismil*, 1499.
 दिहन्वार *dihcār*, 1203, 1434, 1438, 1456.
 दिहन्वार पूजा *dihcār pūja*, 1434.
 दिहँस *dihāns*, 784, 790, 1226.
 दिही *dīhi*, 1218.
 डौंडा *dinra*, 784a.
 डौंढो *dinro*, 784a.
 डौंड़ी *dūri*, 994, 1017.
 डोब *dib*, 547.
 डोबा *diba*, 658.
 डोभी *dibhi*, 986, 994.
 डौंरी *dūri*, 1004.
 डील *dil*, 95, 790, 791, 793.
 डीला *dila*, 95, 788.
 डीलो *dilo*, 95.
 डीच *dih*, 784, 790, 793, 796, 1234.
 दुँड़िया *duñriya*, 1107.
 दुप्पा *duppha*, 1272.
 दुभा *dubha*, 677, 690.
 दुभी *dubbi*, 1018.
 दुबा *dūba*, 1458.
 दूबो गेलै *dūbo gelai*, 1477.
 डउदिया *deurhiya*, 1479.
 देउही *deurhi*, 1254.
 देओहा *deorha*, 1479.
 देगन्ची *degchi*, 448, 711.
 देगौनी *dengani*, 887.
 देँडौका *deñrauka*, 1010.
 देहपट्टा *derhpatta*, 730.
 देहपट्टी *dherpatti*, 730.
 देहसेरी *derhseri*, 912, 1500.
 देहूआ *derhua*, 1183.
 देहौरा जोर *derhaurā jor*, 110.
 देयोगा *deyora*, 1075.
 देहरी *dehri*, 77, 310, 1436.
 देग *deg*, 711, 1491, 1492, 1495.
 देँग *deng*, 103.
 देँगी महुआ *dengi machhua*, 232.
 देह *derh*, 473, 792, 1127, 1479.
 देह कौआ *derh kaua*, 792.
 देह खम्हा *derh khamha*, 173.
 देह पैसे रुपैया *derh paise rupaiya*, 1479.
 देहा *derha*, 1479.

डेही *derhi*, 1475.
 डेफ *deph*, 957.
 डेफ निक-सल *deph niksāl*, 957.
 डेफी *dephi*, 957.
 डेब *deb*, 1101.
 डेभन *dhebban*, 40.
 डेर *der*, 1110.
 डेरा *dera*, 1236, 1237, 1254.
 डेली *deli*, 44, 46, 319f.
 डेवद *dewarh*, 1117.
 डैया *daiya*, 1453.
 डोकनी *dokni*, 717.
 डोंडून्हा *donrha*, 734.
 डोभन्हा *dohra*, 833.
 डोरन्बन्हा *dorbandha*, 363.
 डोहरा *dohra*, 319h, 305.
 डोहररी *dohri*, 462.
 डोहन्हा *dohla*, 319h.
 डोहा *doa*, 450, 718.
 डोइ *doi*, 449, 718, 1380.
 डोण्ट *doët*, 231.
 डोषन्हा *doša*, 718.
 डोकी *doki*, 44, 661, 718.
 डोंगा *donga*, 450.

डोंडू *donr*, 646.
 डोंडा *donra*, 17, 734, 889.
 डोंडूरी *donri*, 646.
 डोभव *dobhab*, 857.
 डोभा *dobha*, 316, 857, 864.
 डोम *dom*, 1419.
 डोमा *doma*, 786, 996.
 डोमा करैल *doma karail*, 786.
 डोर *dor*, 113, 115, 117, 949.
 डोरी *dori*, 115, 117, 145, 216, 362,
 398, 425, 470, 475, 642, 718,
 949.
 डोरीक *dorik*, 359.
 डोरीक सर *dorik sar*, 359.
 डोरो *doro*, 1020.
 डोल *dol*, 694, 695, 720, 924, 929,
 1290.
 डोल कहुई *dol karhui*, 1290.
 डोली *doli*, 241, 247.
 डोले *dole*, 1087.
 डोहट *dohat*, 231.
 डोहर *dohar*, 794.
 डोदी *dyorhi*, 828.
 डौदा *dyaurhu*, 1092.

॥ ढ dh ॥

ढक *dhak*, 1499.
 ढकन्डकिया *dhakdhakiya*, 68.
 ढकन्ना *dhakna*, 84, 544, 700, 711,
 713, 717.
 ढकनी *dhakni*, 438, 713, 1422.
 ढकिया *dhakiya*, 44.
 ढंचन्री *dhanchri*, 585.
 ढट्टा *dhatta*, 362A, 896, 983, 986,
 987, 990, 1153.
 ढठेरा *dhathora*, 986.
 ढड्डा *dhaddha*, 1468c, 1472 ; Appen-
 dix, 14.
 ढपन्ना *dhapna*, 79, 700, 711.
 ढपौना *dhapauna*, 562.

ढबन्डबन्वा *dhabdhabwa*, 68.
 ढबन्री *dhabri*, 787.
 ढरन्का *dharka*, 1168, 1173.
 ढरन्की *dharki*, 363.
 ढरन्निहार *dharnihār*, 943.
 ढरन्नी *dharni*, 564.
 ढरन्नी अकुरी *dharni akuri*, 564.
 ढरन्वा *dharua*, 215, 224.
 ढरन्वा *dhanrua*, 215.
 ढरेवाला *dharewāla*, 561.
 ढसन्कौषा *dhalkaua*, 68.
 ढही *dhahi*, 67.
 ढाकनि *dhākani*, 713.
 ढाकर *dhākar*, 1164.

दाका *dhāka*, 44.
 दाकी *dhāki*, 44, 1055.
 दाको *dhāko*, 1234.
 दाँचा *dhāncha*, 585.
 दाठ *dhāth*, 895, 1132, 1153, 1416.
 दाठा *dhātha*, 96, 724, 1132.
 दाँठा *dhāntha*, 362A.
 दाड़ा *dhāra*, 560.
 दादा *dhārha*, 751, 1080.
 दाढ़ी *dhārhi*, 1080.
 दाब *dhāb*, 787.
 दाबल्ली *dhābli*, 1000.
 दाबा *dhāba*, 1242.
 दाभ *dābh*, 1004.
 दाख *dhārab*, 1451.
 दाखा *dhāra*, 532.
 दाबखा *dhārua*, 224.
 दासा *dhāta*, 197, 216.
 डालुआँ *dhāluān*, 224.
 दाँसी *dhānsi*, 1173.
 दाह *dhāh*, 792.
 दिबन्नी *dhibri*, 325, 417.
 दिभन्का *dhimka*, 713.
 दीदारी *dhūdhāri*, 1308.
 दीबर *dhubar*, 790.
 डुरन्का *dhurka*, 918.
 डल्ला *dhulla*, 894.
 दुसन्मार *dhusmār*, 1098.
 दुसियाअब *dhusiyābh*, 1098.
 दुसियाआ *dhusiyāha*, 1098.
 दुस *dhūs*, 1098.
 दुस *dhūs*, 1098.
 दुस मारब *dhūs mārāb*, 1098.
 दुस मारब *dhūs mārāb*, 1098.
 दुसा *dhūsa*, 1098.
 दुसा मारब *dhūsa mārāb*, 1098.
 दुह *dhūh*, 791, 793.
 दुही *dhūhi*, 791, 793.
 दुक्याँस *dhenkwāns*, 66.
 दुकुआ *dhenkua*, 256, 274, 726.

दुकुआस *dhenkūas*, 66.
 दुकुला *dhenkula*, 928.
 दुकुआ *dhenkūha*, 274.
 दुबुआ *dhebua*, 1497.
 धेम्नौ *dhemni*, 1280.
 धेरिया *dhenriya*, 1073.
 धेरिया मिरन्घार *dheñriya mīrchāi*,
 1073.
 धेल्न्मास *dhelmās*, 66.
 धेल्न्वा *dhehwa*, 1456.
 धेल्न्वा गोसाँई *dhehwa gosāin*, 1456.
 धेल्न्वाँस *dhehewāns*, 66.
 धेल्न्हा *dhehha*, 1456.
 धेल्न्हा पीर *dhehha pīr*, 1456.
 धेल्नौरी *dhehauri*, 66.
 धेक *dhenk*, 291.
 धेका *dheka*, 608.
 धेका *dhenka*, 256, 261, 274, 608,
 726, 1250.
 धेकी *dhenki*, 431, 464, 608, 928, 1250.
 धेकुल *dhenkul*, 608, 928, 931.
 धेद *dhehrh*, 1017.
 धेही *dhenhi*, 994, 996, 1001, 1004,
 1029, 1017.
 धेही लागल है (or बा) *dhenrhi lāgal*
hai (or bā), 1001.
 धेन *dhen*, 1158.
 धेन के दूध *dhen ke dudh*, 1158.
 धेनु *dhenū*, 1114.
 धेपी *dheñpi*, 1051.
 धेमा *dhemā*, 541.
 धेरी *dheri*, 82, 849, 890, 892, 893.
 धोलन्ना *dholna*, 765.
 धोलन्ना चौकी *dholna chauki*, 765.
 धोसवाँच *dhoswāch*, 949.
 धोका *dhoka*, 1125, 1265.
 धोंगा *dhongā*, 372.
 धोंही *dhourhi*, 1017.
 धोली *dholi*, 1053, 1054, 1055.
 धोस *dhos*, 949.

॥ त t ॥

तठ *ta*, 356, 363, 829, 833.

तँ *tañ*, 1451.

तकरै *takrai*, 1090.

तकलो *taklo*, 741 (footnote).

तकिया *takiya*, 637.

तकेया *takeya*, 637.

तकर *takkār*, 1272.

तखतपोष *takhatpos*, 635.

तखन्त रवाँ *takht rawān*, 241.

तखन्ता *takhta*, 222, 414, 457, 467,
475, 587, 832, 1214.

तखन्ती *takhti*, 222, 587.

तखाना *takhāna*, 1241.

तगधरी *tagdhari*, 491.

तगन्ही *taghi*, 108.

तगाड़ *tagār*, 430.

तगाड़ी *tagāri*, 39, 430, 714.

तगार *tagār*, 430, 1014.

तगावी *tagāvi*, 1157, 1190.

तङ्ग *tung*, 226.

तङ्गी *tungi*, 128 (footnote), 130.

तज *taj*, 1381.

तड़क *tarak*, 223, 1252, 1257.

तड़न्तड़वाँ *tartarwān*, 241.

तड़ाका *tarāka*, 585b.

तँतवा *tambca*, 355.

ततुरियाप्रल *taturiyāpāl*, 1076.

तँदूर *tandur*, 446.

तन *tan*, 1375.

तनाव *tanāv*, 390.

तनिका *tanika*, 1056.

तनर *tanūr*, 446.

तमी *tami*, 642.

तपन्नाह *tapnāh*, 800.

तथ *tab*, 356, 393, 1088, 1113.

तथजारी *tahjāri*, 1201.

तथय *tabay*, 1084.

तथसक *tablak*, 1466.

तथाक *tabāk*, 711, 713.

तथाख *tabākh*, 711.

तँबिया *tambiya*, 3191.

तमग्वैल *tamghail*, 693.

तमग्वैला *tamghaila*, 693.

तमन्नी *tammi*, 865, 867.

तमन्हा *tamha*, 689.

तमन्हेड़ी *tamheri*, 675.

तमाकुफरोश *tamākupharosh*, 464.

तमाकुल *tamākul*, 1021.

तमाकुलवाला *tamākulwāla*, 464.

तमाकुलवाला *tamākulwāla*, 464.

तमाकू *tamāku*, 1021, 1026, 1452.

तमान *tamān*, 727.

तमासा *tamāsa*, 128 (footnote), 356.

तमिया *tamiya*, 319g, 372, 670.

तमियाँ *tamiyān*, 3191.

तम्हेड़ा *tamhera*, 556.

तर *tar*, 1234.

तररै *tarai*, 751.

तरकट्टी *tarkatti*, 378, 713.

तरकारी *tarkāri*, 1073.

तरकी *tarki*, 764.

तरकोंका *tarkonka*, 1073.

तरख *tarakh*, 26.

तरन्हा *tarchha*, 50.

तरन्ही *tarchhi*, 39, 126, 606.

तरजूषा *turjūa*, 640.

तरजूरै *turjūrāi*, 47, 462, 555, 640.

तरजू *turju*, 640.

तरम्हार *tarjhār*, 888.

तरनगर *tarangar*, 1252.

तरपचन्ना *tarpachra*, 251.

तरन्वूज *tarbūj*, 1064.

तरन्वूजा *tarbūja*, 1064.

तरन्यानी *taryāni*, 788.

तरन्ना *tarra*, 1493.

तरल *taral*, 1272.

- तरगला *tarla*, 474.
 तरन्वार *tarwār*, 655.
 तरन्चरूल *tarsail*, 938.
 तरन्चिवाद् *tarsivādi*, 792.
 तरन्सैला *tarsaila*, 14, 938.
 तरन्सोखा *tarsoa*, 922.
 तरन्हरा *tarahra*, 1241.
 तरन्हा *tarha*, 1493.
 तरागोतन्सरग्ग *tarāgotsarg*, 1459.
 तराजू *tarāju*, 47, 462, 555, 640.
 तराय *tarāy*, 751.
 तरासी *tarāshi*, 1411.
 तरी *tari*, 788, 789, 792, 901, 914, 960.
 तरु *taru*, 726 (footnote).
 तरेर *taver*, 1262.
 तरेरा *tavera*, 225, 1246, 1262.
 तरैनी *taraini*, 461.
 तरैल *taraila*, 12.
 तरैली *taraili*, 12.
 तरोइ *taroi*, 1069.
 तरौटा *tarauta*, 620.
 तरौड़ी *tarauri*, 284.
 तरौना *taranna*, 49, 461.
 तरौनी *taranni*, 461.
 तलाइ *talai*, 916.
 तलाव *talāv*, 916.
 तलैया *talaiya*, 916 (footnote).
 तलौटा *talauta*, 620.
 तवक *tavak*, 226, 765.
 तवा *tava*, 676.
 तसत *tasat*, 711.
 तसन्तरी *tastari*, 678, 711, 713.
 तसन्मरे *tasmai*, 1272.
 तसन्मा *tasma*, 226, 415, 470.
 तसन्लवा *taslava*, 664.
 तसन्ला *tasla*, 664, 666.
 तसन्ली *tasli*, 665.
 तससुर *tassur*, 1490.
 तसन्खाना *takhkhāna*, 1241.
 तसन्जारी *tahujāri*, 1201.
 तहन्बन्ध *tahband*, 726.
 तहन्बील *tahbāl*, 1463b.
 तहन्मद *tahmad*, 726.
 तहन्सिलन्दार *tahsildār*, 1208.
 तहाँ *tahān*, 655.
 तही *tahi*, 726, 739.
 ताइ *tāi*, 676, 713.
 ताख *tākh*, 1253.
 ताखा *tākha*, 1253.
 ताखी *tākhi*, 725.
 तागा *tāga*, 123, 133b.
 ताँगा *tānga*, 178, 214, 224.
 ताज *tāj*, 725, 1272.
 ताज खानो *tāj khāni*, 1272.
 ताड़ *tār*, 379, 1092.
 ताड़ब *tārab*, 1484.
 ताड़ी *tāri*, 378, 379, 713.
 ताँत *tānt*, 113, 335d.
 ताँती *tānti*, 355.
 ताँतो *tānto*, 355.
 ताथी *tāthi*, 784b.
 तान *tāw*, 224, 245, 249, 322.
 ताना *tānā*, 363.
 तानि *tāni*, 1234.
 तानो *tāni*, 358, 642.
 तानी करब *tāni karab*, 358.
 ताबन्दान *tābdān*, 1249.
 ताँबा *tāmba*, 668, 1451.
 तामब *tāmab*, 865, 867.
 तामा *tāma*, 319h, 343.
 तामिया *tāmiya*, 319g.
 तामो *tāmi*, 670.
 ताँमी *tāmmi*, 372.
 ताभूज *tābhūj*, 1064.
 तार *tār*, 326, 379, 1084, 1456;
 Appendix, 14.
 तारक *tārak* *chhaja*, 68.
 तारन *tāran*, 1252.
 तारा *tāra*, 585d.
 तारी *tāri*, 379, 999 (footnote).

तारीखवार *tarikhwār*, 1470.
 ताल *tāl*, 918.
 ताला *tāla*, 1250.
 तालुका *tāhuka*, 1207, 1233.
 तालुकादार *tālukādār*, 1207.
 तालुकादारी *tālukādāri*, 1207.
 ताव *tāw*, 289, 455.
 तावा *tāwa*, 226, 676, 711, 860, 922.
 तावा दूट गेल *tāwa dūt gel*, 922.
 तावीज *tāwīj*, 754, 765.
 तास *tās*, 1272.
 तास खानी *tās khāni*, 1272.
 तासन *tāsan*, 362.
 तासन करब *tāsan karab*, 362.
 ताहि *tāhi*, 1234.
 तिउनी *tiuni*, 733.
 तितल्ली *tilli*, 1183.
 तिनिली *tilili*, 1074, 1075.
 तिनोद *titoi*, 1183.
 तिनका *tinka*, 1310.
 तिनकोनिया *tinkoniya*, 833.
 तिनखण्डी *tinkhandi*, 768.
 तिनखलिया *tinchhaliya*, 769.
 तिनजान्त *tinjānt*, 926.
 तिनद्रा *tindara*, 1236.
 तिननगा *tinnaga*, 768.
 तिनपखी *tinpakhi*, 1427.
 तिनपखी के पिण्डा *tinpakhi ke pinda*
 1427.
 तिनपतिया *tinpatiya*, 1183.
 तिनपहल *tinpahal*, 418.
 तिनपौआ *tinpaua*, 1500.
 तिनफसिआ *tinphasiba*, 803.
 तिनफला *tinphalla*, 418.
 तिनल्लडी *tinlatthi*, 926.
 तिनसेरा *tinsera*, 1500.
 तिनसेरी *tinseri*, 1500.
 तिपाइ *tipāi*, 633.
 तिरतिया *tirtiya*, 1444.
 तिरपहल *tirpahal*, 418.

तिरपहला *tirpaha*, 418.
 तिरपार *tirpāi*, 319j.
 तिरपाह *tirpāl*, 132.
 तिरपाहल *tirphāl*, 418.
 तिरसूल *tirsul*, 1112.
 तिराँटी *tirānti*, 1039.
 तिरानी *tirāti*, 1424.
 तिरिज *tirij*, 1468a and b, 1469,
 1470, 1472.
 तिरिज खसरा *tirij khasra*, 1471.
 तिरिज जिनिसवार *tirij jiniswār*,
 1468a, 1470; Appendix, 5.
 तिरिज तारीखवार *tirij tarikhwār*,
 1470; Appendix, 1a.
 तिरिज पटेवारी *tirij patevāri*, 1468,
 1471; Appendix, 11.
 तिरिज मोफरौद *tirij mophrūd*, 1470,
 1471.
 तिरिज मोलहकी *tirij molhaki*, 1470.
 तिरिज लगित *tirij laggit*, 1470,
 1471; Appendix, 10a.
 तिरिज वासिल बाकी *tirij wāsul bāki*
 1472.
 तिररी *tiri*, 363.
 तिल *til*, 1084, 1423.
 तिलक *tilak*, 1287, 1289, 1318, 1423.
 तिलकनगरी *tilkatari*, 1272.
 तिलकन्देउआ *tilakdewa*, 1318.
 तिलकहन्हा *tilkahra*, 1318.
 तिलकुट *tilkut*, 1272.
 तिलन्दी *tilthi*, 896.
 तिलन्दानी *tildāni*, 734.
 तिलरी *tilri*, 765.
 तिलरँजुर *tilānjur*, 1423.
 तिलरँजुर देब *tilānjur deb*, 1423.
 तिलाठी *tilāthi*, 896.
 तिलिकिया *tilikiya*, 1318.
 तिलिया *tiliya*, 799.
 तिलिया कोही *tiliya korhi*, 799.
 तिलौरी *tilauri*, 1272.

तिलक *tillak*, 1318.
 तिल्ली *tilli*, 592, 1045.
 तिसजौरी *tisjauri*, 1272.
 तिसरिया *tisariya*, 842.
 तिसरी *tisri*, 842, 907.
 तिसियाउर *tisiyaur*, 1272.
 तिसिघौटा *tisianta*, 768.
 तिसौर *tisaur*, 884, 885.
 तिहैया *tihaiya*, 907.
 तीज *tij*, 182, 183, 200, 1443
 तीतिर *titir*, 1088.
 तीथा *titha*, 937, 952.
 तीन *tin*, 953, 1006, 1088, 1089.
 तीन ठेउका *tin theuka*, 953.
 तीन पटावन तेरह कोड़न *tin patāwan
terah koran*, 1006.
 तीनि *timi*, 1089.
 तीनु *tinu*, 393, 1025.
 तीनो *tino*, 1486.
 तीथन *tiyan*, 1073.
 तीर *tir*, 1456.
 तीरथ *tirath*, 1460.
 तील *ti*, 1045, 1089.
 तीली *tuli*, 498, 502, 592.
 तीसी *tisi*, 356, 1045.
 तुकमा *tukma*, 729.
 तुम *tam*, 1087.
 तुमङ्गी *tumri*, 782.
 तुम्बा *tumba*, 715, 782.
 तुम्मा *tumma*, 715, 782.
 तुम्पाई *tumpai*, 748.
 तुम्हा *turha*, 1456.
 तुम्हाइ *turāi*, 731.
 तुम्क *turuk*, 999 (footnote).
 तुम्गङ्गा *tulangra*, 170.
 तुम्बुली *tulbulli*, 996.
 तुम्सी *tulsi*, 414, 977, 1183,
1451.
 तुम्नी नाँबा *tulsi tāmba*, 1451.
 तुम्सी फूल *tulsi phūl*, 977.

तुला *tula*, 1090.
 तुलाइ *tulāi*, 222.
 तुलावा *tulāwa*, 167, 168, 187, 188,
204, 221, 222.
 तू *tū*, 1084.
 तुम्ब *tūnab*, 334.
 तुम्ब *tūnab*, 334.
 तुम्ब *tūnab*, 334.
 तुम्मा *tūma*, 715, 782.
 तूर *tūr*, 333.
 तूरत वा *tūrat ba*, 246.
 तूरब *tūrab*, 1024.
 तूरल *tūral*, 240.
 तूर *tūre*, 1486.
 तुल *tul*, 640, 1470.
 तुम्हाइ *tūh*, 1278.
 तेकानी *tekāni*, 173.
 तेकुना *tekuna*, 1059.
 तेकुरा *tekura*, 907.
 तेकुरी *tekuri*, 907.
 तेकुली *tekuli*, 907.
 तेखन्ना *tekhra*, 820.
 तेखुरी *tekhari*, 907.
 तेघाँव *teghāw*, 953.
 तेघावा *teghāwa*, 953.
 तेजजा *tejatta*, 926.
 तेतरी *tetri*, 1397.
 तेतगला *tehta*, 204.
 तेतलिया *tehaliya*, 204.
 तेतार *tetār*, 1183.
 तेतारी *tehari*, 1183.
 तेतुला *teputa*, 204.
 तेधरी *tedhri*, 1097.
 तेधुरा *tedhura*, 1097.
 तेपई *tepati*, 633.
 तेपकी *tepakhi*, 996.
 तेपहल *tephal*, 319, 118.
 तेपाइ *tepai*, 633.
 तेफला *tephalla*, 403.
 तेबिदा *tebida*, 1278

तेररा *terra*, 959.
 तेलचट *telehat*, 1074.
 तेलही *telatthi* 926.
 तेलभाँडा *telbhāwa*, 663.
 तेलरी *telri*, 765, 1039.
 तेलचण्डा *telhanda*, 663, 713.
 तेलचण्डन *telhan*, 1045.
 तेलचण्डन तीसी *telhan tasi*, 1045.
 तेलचण्डाँडी *telhānri*, 713.
 तेलाय *telāy*, 713.
 तेलिया *teliya*, 786.
 तेलिया केवाल *teliya kewāl*, 786.
 तेवारे *tewāre*, 1098.
 तेवारे ओतल *tewāre jotal*, 1098.
 तेसरी *tesri*, 907.
 तेसरो *tesro*, 1007.
 तेहरावन *tehrāwan*, 520.
 तेकर *tekar*, 823, 1086.
 तेखार *tekhār*, 820.
 तेगा *tenga*, 1294.
 तेजी *teji*, 1039.
 तेतर *tetar*, 1397.
 तेफल *tephal*, 403, 418.
 तेरह *terah*, 1006, 1088.
 तेल *tel*, 347, 1043, 1045, 1308,
 1378, 1458.
 तेल चढाप्रब *tel churhāeb*, 1378.
 तेली *tehi*, 255, 572.
 तेसर *tesar*, 1007.

तेसर (or तेसरो) पढावन (or पानी) *t*
 (or *tesro*) *aptāwan* (or *pāni*), 1
 तैयार *taiyar*, 1118.
 तैती *tañti*, 757.
 तोडाप्रब *torāeb*, 888.
 तोबडा *tobra*, 134, 227.
 तोरना *torna*, 585b.
 तोरियठ *toriyath*, 896.
 तोरिया *toriya*, 1119.
 तोरियाठी *toriyāthi*, 896.
 तोरियान *toriyān*, 1119.
 तो *to*, 1091.
 तोगर *togar*, 569.
 तोहन *toran*, 1042.
 तोड़ब *torab*, 240, 981.
 तोड़ा *tora*, 757.
 तोर *tor*, 664 (footnote).
 तोरी *tori*, 823, 1045.
 तोला *tola*, 1498, 1499.
 तोसक *tosak*, 637.
 तौलार *taulāi*, 914.
 तौ *taun*, 1087.
 तौनी *tauni*, 733.
 तौल *taul*, 1118.
 तौला *taula*, 69, 143, 319,
 378, 437, 713.
 तौली *tauli*, 665.
 त्रितिवर *tritibar*, 1278.
 तौ *tyon*, 737.

॥ थ th ॥

थक *thak*, 1034.
 थकरी *thakri*, 747.
 थकुरर *thakurai*, 867.
 थका *thakka*, 531.
 थनमार *thannār*, 1477.
 थनैलियाची *thannilyachi*, 1395.
 थनैली *thannili*, 1395.
 थपरी *thapri*, 137, 713.

थपुआ *thapua*, 624, 1262.
 थम *tham*, 500.
 थमनी *thanni*, 613.
 थमुआ *thamua*, 1259.
 थमआ *thamhwa*, 1259.
 थरिया *thariya*, 680, 460.
 थला *thalla*, 500.
 थवरी *thawai*, 420, 1261.

थङ्गसल *thakusal*, 1094.
 थाकल *thākal*, 657.
 थान *thān*, 1455.
 थापी *thāpi*, 282, 307, 424, 431.
 थारी *thāri*, 460, 680, 681, 682, 1316,
 1401, 1408.
 थारी बजाएब *thāri bajāeb*, 1401.
 थाल *thāl*, 713, 460
 थुकन्हा *thukha*, 1173.
 थुन्ही *thunhi*, 940.
 थुम्भा *thumbha*, 363.
 थुम्भी *thumbhi*, 363, 1259.
 थूचा *thūa*, 1048.
 थूनु *thūnu*, 500.
 थून्ही *thūnhi*, 1256, 1259.
 थूम *thūm*, 363.

थैया *thaiya*, 318.
 थैर *thair*, 1118.
 थैला *thaila*, 734.
 थैली *thaili*, 734.
 थैलीमार *thailimār*, 1477.
 थोङ्गली *thorli*, 359.
 थोलगरी *tholri*, 359.
 थोक *thok*, 531, 1214.
 थोड़ी *thori*, 359.
 थोप *thop*, 177, 189, 249.
 थोभ *thobb*, 189, 192, 201, 221.
 थोर *thor*, 829.
 थौक *thanth*, 531.
 थौना *thouna*, 500, 1247.
 थौसल *thausal*, 1094.
 थौंसा *thausa*, 1094.

॥ द ॥

दई *dai*, 1295.
 दखिनन्हा *dakhinha*, 1074.
 दखिनाहा *dakhināha*, 1074, 1160.
 दखिनाहा घु *dakhināha ghyu*, 1160.
 दगन्दार *dagdār*, 1076.
 दगध करब *dagadh karab*, 1416, 1419.
 दगन्नी *dagni*, 359.
 दगन्निन *dagrin*, 1400.
 दगन्ली *dagli*, 224.
 दँगाठ *dangāth*, 1079.
 दगियाल *dagiyāl*, 1004.
 दखिनी *dakhini*, 1057.
 दड़िमी *darimi*, 1272.
 दहिवा *darhiya*, 346.
 दत *dat*, 1196, 1197.
 दँतकमरा *dant kamra*, 984.
 दँतनर *dantnar*, 1173.
 दतभोजन्नी *datbhajni*, 1197.
 दतुवन *datuan*, 747.
 दँतुवा *dantua*, 216.
 दंतुला *dantula*, 73.

ददिचौरा *dudiaura*, 1299.
 ददिहर *dudihar*, 1299.
 ददिहार *dudihār*, 1299.
 ददिहाल *dudihāl*, 1299.
 दनन्जाउर *danjāūr*, 1272.
 दनियाली *duniyāli*, 585a.
 दनौरी *dunauri*, 1272.
 दन्त *dant*, 568, 1113, 1173.
 दन्त लहर *dant lahar*, 1173.
 दफ्तरी *daphdari*, 586.
 दफन्दरी *daphdari*, 586.
 दबकन *dhakkan*, 81, 309, 713.
 दबठा *dabthā*, 549.
 दबन्नी *dabni*, 398.
 दबन्लिया *dabliya*, 1000.
 दबिया *dabiya*, 439, 583, 1111.
 दबिला *dabila*, 439.
 दबोर *daboi*, 1267.
 दबौटा *dabauta*, 322, 398.
 दम *dam*, 145.
 दमकट्टी *dankatti*, 913.

दमका *damka*, 796.
 दमङ्गी *damri*, 1497.
 दमदमाचा *damdamācha*, 472.
 दमहरिया *damhariya*, 44.
 दमाव *damāo*, 913, 1471.
 दमाव गङ्गा *damāo galla*, 1471.
 दमाही *damāhi*, 887.
 दम्मी *dammi*, 472.
 दर *dar*, 1220, 1479.
 दरखोल *dar'khol*, 1153.
 दरज *daraj*, 748.
 दरजी *darji*, 393, 718.
 दरपतनी *darpatni*, 1211.
 दरपन *darpan*, 383, 765.
 दरबन्दी *darbandi*, 1220.
 दग्माहा *darmāha*, 1185.
 दरमी *darmi*, 965e.
 दरग्याबादी *daryābādi*, 769.
 दररा *darra*, 1272.
 दरवजा *darwaja*, 1254.
 दरवजा *darwajja*, 1249.
 दरवजा *darwāja*, 562, 1249.
 दरसनौ *darsani*, 1487.
 दरसूधा *darsūdha*, 238.
 दरसूधा के मलिया *darsūdha ke maliya*,
 238.
 दरा *dara*, 1272.
 दराज *darāj*, 243, 401.
 दरी *dari*, 750.
 दरींची *darinchi*, 1249.
 दरुद *darūd*, 1432.
 दरेंची *darainchi*, 1249.
 दरोखा *darokha*, 1239.
 दरोजा *darōja*, 1249.
 दरौजा *darauja*, 1249, 1254.
 दमङ्की *dalki*, 789.
 दलदल *daldal*, 789.
 दल्पिठी *dalpithi*, 1272.
 दल्पिठौरी *dalpithauri*, 1272.
 दल्पेता *dalpainta*, 1001.

दलसग्गा *dalsagga*, 1001, 1272.
 दलङ्ही पूरी *dalhi pūri*, 1272.
 दलान *dalān*, 1239, 1254, 1388.
 दलाली *dalāli*, 1474.
 दवड़ *dawar*, 921.
 दवन *dawan*, 832, 954.
 दवर *dawar*, 235, 941.
 दवात *dawāt*, 713, 1034, 1442.
 दवात पूजा *dawāt puja*, 1442.
 दवाँची *dawānhi*, 887, 889.
 दस *das*, 711.
 दसकरम *daskarm*, 1425.
 दसगरदँ *dasgardān*, 1476.
 दसगतनर *dasgatr*, 1425.
 दसपना *daspana*, 711.
 दसवाँ *daswān*, 1423, 1425.
 दसहरा *dasahra*, 1381, 1393.
 दसहरा के जोड़ा *dasahra ke jora*,
 1381.
 दसहरा खाना *dasahra khāna*, 1393.
 दसाही *dasāhi*, 1425.
 दसेर *daser*, 940.
 दसौड़ी *dasaurhi*, 1250.
 दसौड़ी चौकठ *dasaurhi chankath*,
 1250.
 दसौत *dasaut*, 1353.
 दस *dast*, 711.
 दसगरदँ *dastgardān*, 1476.
 दसपनाह *dastpanāh*, 711.
 दस्ता *dasta*, 335h, 706.
 दस्ती *dasti*, 585, 720.
 दस्ती कुप्पा *dasti kuppā*, 720.
 दस्तुरी *dasturi*, 1474.
 दहङ्गी *dahri*, 713.
 दहार *dahār*, 912, 1080.
 दहार महार *dahār mahār*, 912.
 दहि *dahi*, 1162.
 दहिष्क *dahiak*, 1198, 1203.
 दहिष्क माँगन *dahiak māngan*, 1198.
 दहिन *dahin*, 817.

- दहिन धरेचाव *dahin dhareāo*, 817.
 दहिना *dahina*, 827.
 दहिघा *dahiya*, 1074.
 दहियाण *dahiyāṅ*, 1004.
 दहियाची चाँडी (or कडाची) *dahiyāh hāri* (or *karāhi*), 138.
 दहिककी *dahikakki*, 1192.
 दही *dahi*, 138, 713, 990, 1162, 1324.
 दहेल *dahaj*, 1283, 1339, 1347.
 दहेरी *daheri*, 138, 713.
 दाउदी *dāudi*, 956.
 दाखिला *dākhila*, 1467.
 दाँगली *dāngli*, 184.
 दाँडू *dāure*, 1085.
 दाही *dāhi*, 346, 356.
 दाँत *dānt*, 73, 401.
 दाँत रन्दा *dānt randa*, 401.
 दाँतुआ *dāntua*, 585b.
 दादन *dādan*, 1040.
 दादणी *dādni*, 1028, 1040.
 दाँदर *dādar*, 868.
 दादा *dādā*, 463.
 दादीचाल *dādīchāl*, 1299.
 दान *dān*, 1334, 1457, 1459.
 दाना *dāna*, 856, 904, 1030, 1031, 1268, 1272, 1470.
 दाना दूनी *dāna dūni*, 1268.
 दानाबन्दी, *dānābūdi*, 913, 1168a, 1470.
 दानी *dāni*, 447, 1194, 1273.
 दानो *dāno*, 1438.
 दानो पूजा *dāno pūja*, 1438.
 दाब *dāb*, 168, 322, 439, 457, 583.
 दाबा *dāba*, 319l, 457, 718.
 दाबि *dābi*, 718.
 दाबी *dābi*, 457.
 दाम *dām*, 1487, 1496, 1497.
 दाँमर *dāmmar*, 889.
 दाल *dāl*, 1002n, 1272, 1369.
 दाल धोरे *dāl dhōr*, 1369.
 दाल पीठी *dāl pithi*, 1272.
 दाल शोरे *dāl shōr*, 1369.
 दाब *dāw*, 86.
 दाँवब *dānwab*, 888.
 दाँवल *dānwāl*, 1119.
 दावा *dāwa*, 1251.
 दावागीर *dāwāgir*, 655.
 दास *dās*, 1456.
 दाह *dāh*, 1416.
 दाह देब *dāh dēb*, 1116.
 दिअका *diaka*, 1074.
 दिअँका *dianka*, 1074.
 दिअरल *diaral*, 1253.
 दिअरगवा *diaragwa*, 1253.
 दिअरा *diara*, 788.
 दिअँका *dianka*, 1074.
 दिअरी *diari*, 713.
 दिअली *diali*, 713.
 दिन *din*, 965, 966, 1087, 1091, 1343.
 दिन युधी करब *din yūthi karab*, 1343.
 दिनहर *dinhar*, 874.
 दिहुक *dihuk*, 1088.
 दिनौरा *dinaura*, 874, 914.
 दिपग्दान *dipdān*, 780.
 दिपन्दानी *dipdāni*, 780.
 दिपगा *dipga*, 702.
 दिपहरा *dipahra*, 702.
 दिघरी *diyari*, 713.
 दिथँडा *diyānda*, 1074.
 दिघार *diyār*, 1074.
 दिघारा *diyāra*, 788.
 दिघारी *diyāri*, 713.
 दिल्लन्हा *dilka*, 247.
 दिवार *diwār*, 1074, 1251.
 दिवाला *diwāla*, 1486.
 दिवाला उखडि गोलैहि *diwāla ukhari gelañhi*, 1486.
 दिवाला निकसब *diwāla niksab*, 1486.

- दिवाला निकासन *divāla nikāsab*, 1486.
 दिवाला सुध हो जाएब *divāla sudh ho jāeb*, 1486.
 दिवालिया *divaliya*, 1486.
 दिस *dis*, 849 (footnote).
 दिस्ता *dista*, 335h, 706.
 दिस्था *distha*, 335h.
 दिहलस *dihlas*, 1116.
 दीचठि *diathi*, 702.
 दीनी *dini*, 874.
 दीप *dip*, 713.
 दीपक *dipak*, 585f.
 दीयट *diyāt*, 702.
 दीयर *dyar*, 784, 785.
 दीया *dyā*, 713, 1316, 1423.
 दीयाँ *dyān*, 1074.
 दीया बाती *dyā bāti*, 1423.
 दीरठ *dira*, 788.
 दीरा *dira*, 788.
 दीरी *diri*, 713.
 दीवट *divat*, 702, 711.
 दीवाल *divāl*, 247, 1251.
 दोहड *doha*, 829, 1113.
 दुष्नी *duanni*, 1201, 1499; Appendix, 14.
 दुष्रिया *duariya*, 1238.
 दुष्ार *duār*, 454, 1238, 1247, 1249, 1254, 1319, 1335, 1352.
 दुष्ार केंकार *duār chhenkāi*, 1335, 1352.
 दुष्ार केंकौनी *duār chhenkāni*, 1335.
 दुष्ार पूजा *duār pūja*, 1319.
 दुष्ार लगार *duār layāi*, 1319.
 दुष्ारी *duāri*, 247, 1249.
 दुष्ाली *duāli*, 17.
 दुइ *dui*, 1087.
 दुइबियाहा *duibiyāha*, 1278.
 दुकानी *dukāni*, 933.
 दुख *dukā*, 1085.
 दुगोटिया *dugotiya*, 639.
 दुगोड़ी *dugori*, 31, 549.
 दुजन्ता *dujanta*, 926.
 दुजान *dujāt*, 926.
 दुनिबर *dutibar*, 1278.
 दुरन्त *dudant*, 1118.
 दुदसर *dudsar*, 970.
 दुदही कँठिया *dudhi kantiya*, 136.
 दुदा *dudha*, 984.
 दुधी *dudhi*, 1422.
 दुधकटुआ *dudhkatua*, 1395.
 दुधकाँवर *dudhkānvar*, 973.
 दुधगिलास *dudhgilas*, 975.
 दुधघोहू *dudhghōttu*, 984.
 दुधदुहा *dudhtutua*, 1395.
 दुधपिलाइ *dudhpilāi*, 1408.
 दुधभोरो *dudhbhoro*, 984.
 दुधमुँह *dudhmunh*, 1422.
 दुधमुँही *dudhmuñhi*, 1422.
 दुधराज *dudhrāj*, 972.
 दुधा मकर *dudha makar*, 984.
 दुधार *dudhār*, 1117.
 दुधारि *dudhāri*, 1117, 1157.
 दुधिया *dudhiya*, 956, 985, 1075, 1183.
 दुधियाएल *dudhiyāel*, 957.
 दुधैल *dudhailai*, 957.
 दुनु *dunu*, 226 (footnote).
 दुपतियो *dupatiyo*, 1018.
 दुपहरिया *dupahariya*, 842.
 दुबगली *dubagli*, 111.
 दुब्धी *dubbi*, 1183.
 दुमकजा *dumkaja*, 226.
 दुमची *dumchi*, 226.
 दुमुँहाँ *dumuñhān*, 1239.
 दुग्गा *durga*, 1198.
 दुग्गा पुजार *durga pujāi*, 1198.
 दुग्जन *durjan*, 655.
 दुरागन्धन *durāgnghan*, 1292.
 दुरागमन *durāgaman*, 1291.

- दुरागौन *durāgaun*, 1291.
 दुरस *durus*, 1398.
 दुरौष *duraundh*, 1251, 1335.
 दुरौषा *duraundha*, 1251, 1335.
 दुलहरी *aulahri*, 974.
 दुलहा *dulha*, 1274, 1281, 1383.
 दुलहिन *dulhin*, 1282, 1383.
 दुलारी *dulāri*, 965c.
 दुलार *dullar*, 978.
 दुसेरी *duseri*, 912.
 दुहनी *duhni*, 136.
 दुहन्थी *duhanthi*, 414.
 दुहाव *duhāv*, 1159.
 दुहारी *duhāri*, 247, 248, 1238.
 दुहाव *duhāv*, 1201.
 दुहावे *duhāve*, 604
 दुहिया *duhiya*, 1205.
 दुहु *duhu*, 849 (footnote).
 दू *du*, 823, 904, 1113, 1116, 1118,
 1479.
 दूआ *dūa*, 908, 1483.
 दूचास *du chās*, 823.
 दू तौल *du taul*, 1118.
 दूध *dūdh*, 990, 1030, 1157, 1158,
 1165.
 दूधक *dūdhak*, 1166.
 दूधी *dūdhi*, 786, 956.
 दूनी *dūni*, 1268.
 दूब *dūb*, 1183.
 दूबी *dūbi*, 1308.
 दूभ *dūbh*, 868, 1075, 1183.
 दूभ दाँदर *dūbh dāmdar*, 868.
 दूर *dūr*, 1087.
 दूरा *dūra*, 1238.
 दूहव *duhab*, 1157.
 देउही *deurhi*, 1254.
 देवता *devata*, 1455, 1456.
 देहना *dekhna*, 1253.
 देखिह *dekhika*, 1091, 1113.
 देगची *degchi*, 448, 711.
 देवाल *dewāl*, 233.
 देवाला *dewāla*, 1486.
 देवाली *dewāli*, 538.
 देसरिया *desariya*, 965f.
 देसिला *desila*, 956, 1073.
 देहन *dehan*, 1477.
 देहन्द *dehand*, 1477.
 देहरी *dehri*, 1238.
 देहानी *dehāti*, 1263.
 देहुरी *dehuri*, 1202.
 दे *de*, 748, 1025.
 दे के *de ke*, 69.
 देखव *dekhav*, 1428.
 देखर *dekhur*, 1253.
 देखल *dekhul*, 1484.
 देखह *dekhah*, 1113.
 देखि *dekhhi*, 1070.
 देखे *dekhe*, 128 (footnote), 1087.
 देखें *dekhēn*, 568.
 देग *deg*, 372, 711, 713.
 देन *den*, 1284, 1461.
 देन मोहर *den mohur*, 1284.
 देना *dena*, 1151.
 देब *deb*, 58, 585f, 867, 876, 966,
 1087, 1099, 1116, 1385, 1416,
 1419, 1423, 1429, 1431, 1439,
 1452.
 देब उठान *deb uthān*, 1087, 1439.
 देबी *debi*, 1449, 1455, 1456.
 देबी अस्थान *debi asthān*, 1455.
 देबी थान *debi thān*, 1455.
 देल *del*, 250.
 देलनि *delnhi*, 1234.
 देली *delni*, 741.
 देलें *delēn*, 1217.
 देव *deo*, 585f.
 देवठान *deothān*, 1439.
 देवाल *dewāl*, 1251.
 देस *des*, 1088, 1092.
 देसी *desi*, 328, 956, 1021, 1059

- देही *dehi*, 973, 1207, 1215, 1218.
 देही खरन्च *dehi kharch*, 1207.
 दैशाप्रब *daihäëb*, 1078.
 देना *daina*, 1151.
 दोषान *doät*, 1198.
 दोषात पुजार *doät pujäi*, 1198.
 दोषार *doär*, 1238, 1249.
 दोषाली *doäli*, 388, 398, 415.
 दोषाह *doäh*, 1278.
 दोकण्डा *dokra*, 149, 1497.
 दोकरा *dokra*, 1497.
 दोकान *dokän*, 463.
 दोकानो *dokäni*, 373, 933, 940, 1023.
 दोखन्ता *dokhta*, 1023.
 दोगन्ना *dogla*, 956.
 दोगहा *dogaha*, 111, 889.
 दोगाह *dogäh*, 1153, 1239.
 दोगाँव *doghānv*, 953.
 दोगावा *doghāva*, 953.
 दोहरा *dohra*, 1235, 1245.
 दोचारा *dochāra*, 1245.
 दोहपन्ना *dochhapra*, 1245.
 दोत्रा *dotra*, 798.
 दोत्रा चौमास *dotra chaumās*, 798.
 दोत्रा *dotura*, 810, 1006, 1008.
 दोत्रा के ऊख *dotura ke ükh*, 1008.
 दोदन्त *dodant*, 1118.
 दोदन्ता *dodanta*, 1118.
 दोधरिया *dodhariya*, 857.
 दोनवाह *donväh*, 950.
 दोपटा *dopta*, 730, 740.
 दोपट्टा *dopatta*, 724, 730, 740.
 दोपतिया *dopatiya*, 1018.
 दोपत्ती *dopatti*, 1018.
 दोपलिया *dopaliya*, 725, 1245.
 दोपहरिया *dopahariya*, 837, 842.
 दोफसिला *dophasila*, 803, 858.
 दोफसिली *dophasili*, 803.
 दोबगन्गी *dobagli*, 111.
 दोबग्गी *dobaggi*, 111.
 दोबधिया *dobadhya*, 639.
 दोबरन्दा *dobarda*, 31, 149.
 दोबागी *dobāgi*, 111.
 दोबारा *dobāra*, 373.
 दोबिहा *dobihā*, 1278.
 दोमन्डा *domra*, 884.
 दोरन्साही *dorsāhi*, 787.
 दोरसा *dorassa*, 1023.
 दोरसो *dorasso*, 468, 1023.
 दोलगी *dolgi*, 977.
 दोलङ्गी *dolangi*, 974.
 दोलडी *dolatthi*, 926.
 दोलाइ *doläi*, 731.
 दोलाय *dolāy*, 876.
 दोलाय देव *dolāy dev*, 876.
 दोसरा माँटी के बीया *dosra mānti ke biya*, 1057.
 दोसरो *dosro*, 1007.
 दोसरो पटावन *dosro patāvan*, 100.
 दोसलिया *dosaliya*, 803.
 दोसाल *dosāl*, 803.
 दोसूती *dosüti*, 590.
 दोहटा *dohta*, 1218.
 दोहन्था *dohthu*, 852.
 दोहरा *dohra*, 1250.
 दोहरावन *dohrāvan*, 819.
 दोहान *dohän*, 1118.
 दोहार *dohār*, 819, 857.
 दो *do*, 817, 953.
 दोख *dokh*, 1118.
 दोख बैल *dokh bail*, 1118.
 दोखाड़ *dokhār*, 819.
 दोखार *dokhār*, 819, 820.
 दोगा *doga*, 1245.
 दोंगा *donga*, 1294.
 दोंज *donj*, 1011.
 दोंजी *donji*, 1011, 1024, 1039.
 दो ठेउका *do theüka*, 953.
 दोधा *dodha*, 984.
 दोन *don*, 950.

दोना *dona*, 721, 1405.
 दौनी *donni*, 1405.
 दौनी झाँकब *donni jhānkab*, 1405.
 दोनों *donon*, 1088.
 दोबर *dobar*, 1084, 1092.
 दो बाँह *do bānh*, 817.
 दोमा *doma*, 1015.
 दोरब *doras*, 468, 787.
 दोल *dol*, 924, 929.
 दोलब *dolab*, 876.
 दोसर *dosar*, 393, 838, 1007.
 दोसर आँतर धरब *dosar āntar dharab*,
 838.
 दोसर पटावन (*or* पानी) *dosar patā-*
van or pāni, 1007.
 दोहट *dohat*, 1218.
 दोहद *dohad*, 1399.

दोहर *dohar*, 730.
 दो हरा *do hara*, 31.
 दौंगन्डी *daungri*, 184.
 दौदिषा *daudiya*, 956.
 दौग *daug*, 832, 836, 1050.
 दौंगर *daungar*, 836, 1050.
 दौदौ *daudi*, 956.
 दौना *dauna*, 978.
 दौना फूल *dauna phul*, 978.
 दौनी *dauni*, 649, 887.
 दौंरड़ *daurāṛ*, 899.
 दौरा *daura*, 43, 44, 442, 919,
 1317, 1350.
 दौरा में गोर ढारब *daura men gor-*
dārab, 1350.
 दौरौ *dauri*, 43, 44, 442, 887.
 दौरी *dauri*, 887, 889.

॥ ध dh ॥

धकरन्कोच *dhakarchhoh*, 1095.
 धकरा *dhakra*, 1183.
 धंगाएल *dhangāḷ*, 1079.
 धंगाठ *dhangāth*, 1079.
 धंगेड़ *dhanger*, 1079.
 धडाठ *dhagāth*, 1079.
 धचान *dhachān*, 363 (14).
 धचाना *dhachāna*, 363 (14).
 धंधारी *dhandhāri*, 756.
 धन *dhan*, 1092.
 धनःक्रियारा *dhanḥkriyāra*, 981.
 धनःक्रियारी *dhanḥkriyāri*, 812.
 धनःकुट्टी *dhanḥkutti*, 616.
 धनःखर *dhanḥkar*, 812, 981.
 धनःखेत *dhanḥket*, 981.
 धनःखेती *dhanḥkheti*, 981.
 धनःपुरही *dhanḥpurahi*, 1114.
 धनःबट्टी *dhanḥbatti*, 1303, 1309, 1313.
 धनःबाल *dhanḥbāl*, 984.

धनःखर *dhanḥkar*, 812, 981.
 धनःखरा *dhanḥkara*, 984.
 धनःखा *dhanḥka*, 981, 1089.
 धनिषाँ *dhanishāṅ*, 1073.
 धनिषठा *dhanishtha*, 1082.
 धनी *dhani*, 1461.
 धनीवा *dhanīva*, 975.
 धनुही *dhanuhi*, 331, 178.
 धन्यारी *dhanhāri*, 756, 769.
 धमाका *dhamāka*, 213, 224.
 धमाकुल *dhamākul*, 1021.
 धरःखा *dharḥka*, 1253.
 धरःझी *dharḥjhi*, 861.
 धरःती *dharti*, 1433.
 धरःती माइ *dharti māi*, 1433.
 धरःन *dharan*, 322, 1256.
 धरःना *dharana*, 939.
 धरःब *dharab*, 838.
 धरःम *dharan*, 1446.

- धरन्मनाथ *dharmnāth*, 1456.
 धरन्म लग्गी *dharm laggi*, 328.
 धरन्मा *dharmā*, 1446.
 धरल *dharal*, 817.
 धरन्हर *dharhar*, 1234.
 धरिया *dhariya*, 12, 726, 857.
 धरियाप्रब *dhariyāḥb*, 857.
 धरिस *dharis*, 1004.
 धरेचाव *dhareāo*, 817.
 धवर *dhavar*, 1134.
 धसन्ना *dhasna*, 789.
 धाकर *dhakar*, 1095.
 धाध *dhādth*, 1080.
 धान *dhān*, 963, 964, 967, 1084,
 1086, 1087, 1088, 1090, 1091,
 1217, 1303.
 धाप *dhāp*, 1492.
 धामा *dhāma*, 44.
 धार *dhār*, 25, 29, 892, 1451.
 धार अस्त्राप्रब *dhār asrāḥb*, 25.
 धारग्निक *dhārnīk*, 1461.
 धार पजाव *dhār pajāo*, 25.
 धार पिजावल *dhār pijāwal*, 25.
 धार पिठावल *dhār pitāwal*, 25.
 धार फरगावल *dhār phargāwal*, 25.
 धार बनाप्रब *dhār banāḥb*, 25.
 धारा *dhāra*, 643, 975, 1484, 1500.
 धारा करब *dhāra karab*, 1484.
 धारी *dhāri*, 835, 857.
 धारी लग्गाप्रब *dhāri lagaḥb*, 857.
 धावर *dhāvar*, 1134.
 धिंगान *dhingān*, 1201.
 धिमोद *dhimōi*, 1183.
 धिया *dhiya*, 990.
 धी *dhi*, 1295.
 धुषा *dhua*, 67, 68.
 धुञ्जाकस *dhujākas*, 302.
 धुञ्जार *dhujāār*, 1272.
 धुञ्जका *dhundhuka*, 302.
 धुनक्की *dhunkki*, 334.
 धुनक्कठ *dhunhath*, 334.
 धुनिया *dhuniya*, 334, 990.
 धुनियाँ *dhuniyān*, 476.
 धुनेठी *dhunethi*, 334.
 धुनेठ *dhunēth*, 334.
 धुपन्दान *dhupdān*, 779.
 धुपन्दानी *dhupdāni*, 779.
 धुपञ्चहरा *dhupahra*, 779.
 धुपेड़ी *dhuperi*, 779.
 धुरई *dhurāi*, 933, 940.
 धुरन्कमिया *dhurkamīya*, 303.
 धुरन्किल्ली *dhurkīllī*, 164, 203.
 धुरन्गोलो *dhurgolo*, 1135.
 धुरन्घुस्सा *dhurghussa*, 858.
 धुरन्कक *dhurchhak*, 1320.
 धुरन्पा *dhurpa*, 1075.
 धुरन्ही *dhurhi*, 931, 940.
 धुरिया *dhuriya*, 149, 858, 914, 1090.
 धुरिया बावग *dhuriya bāwag*, 858.
 धुरप *dhurup*, 1075.
 धुरौठी *dhurauti*, 174, 175.
 धुसन्रा *dhusra*, 967g.
 धुसन्नी *dhusri*, 965a.
 धुस्सा *dhussa*, 737.
 धू *dhu*, 868.
 धूषा *dhūa*, 1317, 1320.
 धूइ *dhūi*, 489.
 धूध *dhūndh*, 1080.
 धून *dhūn*, 1080.
 धूनब *dhūnab*, 334.
 धूप *dhūp*, 1419.
 धूमन *dhūman*, 347.
 धूर *dhūr*, 833, 851, 1094, 1096,
 1495.
 धूर डाँगर *dhūr dāngar*, 1094.
 धूरा *dhūra*, 166, 203, 221, 489.
 धूरी *dhūri*, 149, 166, 221, 414,
 1096.
 धूस *dhūs*, 737, 785.
 धूसी *dhūsi*, 785.

धूह *dhūh*, 67.
 धूहा *dhūha*, 67.
 धेनुवागर *dhenuāgar*, 1164.
 धेनुन *dheñu*, 1114.
 धेन *dhen*, 1114, 1158.
 धेन के दूध *dhen ke dūdh*, 1158.
 धेनु *dhenu*, 1114.
 धै *dhai*, 1451.
 धै चावल *dhai āwal*, 69.
 धोआँच *dhoāñch*, 1272.
 धोइहें *dhoihen*, 1092.
 धोकण्डा *dhokra*, 719.
 धोकण्डें *dhokren*, 719.
 धोकरी *dhokri*, 734.
 धोबन्डाँग *dhobdāng*, 390.
 धोबिनिथाँ *dhobiniyāñ*, 740.
 धोबिया *dhobiya*, 393.
 धोरखा *dhorkha*, 1253.
 धोरचा *dhorea*, 933, 940.
 धोखन *dhoan*, 1032.

धोखल *dhoal*, 1272.
 धोखल दाल *dhoal dāl*, 1272.
 धोषा *dhoa*, 542.
 धोइ *dhoi*, 1341.
 धोइ *dhoi*, 1032, 1272, 1369.
 धोइल *dhoel*, 391.
 धोए *dhor*, 1032.
 धोकर *dhokar*, 1458.
 धोकर कसवा *dhokar kasavā*, 1458.
 धोंग *dhong*, 1272.
 धोंक *dhonchk*, 1117.
 धोती *dhoti*, 726, 740, 1357.
 धोधर *dhodhar*, 920c.
 धोंधा *dhondha*, 466, 1251.
 धोबिक *dhobik*, 393.
 धोबी *dhobi*, 389, 393, 1092, 1304.
 धौकनी *dhaunki*, 510.
 धौरहर *dhaurahar*, 1234.
 धौना *dhauna*, 500.
 धौर *dhair*, 1134.

॥ न ॥

न *na*, 128, 226, 394, 572, 1026,
 1056, 1084, 1085, 1087, 1234.
 नई *nai*, 740.
 नकहन्दा *nakehanda*, 763.
 नकहिकनी *nakehhikni*, 1075.
 नकटी *nakti*, 20.
 नकपाँचे *nakpāñche*, 1445.
 नकपाँचो *nakpāñcho*, 971.
 नकरई *nakrai*, 1474.
 नकरई सकरई *nakrai sakrai*, 1474.
 नकसोंध *naksondh*, 1146.
 नकादर *nakādar*, 1094.
 नकलोल *naktol*, 114.
 नकैल *nakel*, 114, 1131.
 नकैल *nakail*, 114.
 नखत *nakhāt*, 971, 1082.
 नगडा *nangra*, 301.

नगद *nagad*, 1488.
 नगन्दा *nagda*, 1488.
 नगन्दा नगन्दी *nagda nagdi*, 1488.
 नगन्दी *nagdi*, 902, 1198, 1221,
 1225, 1488.
 नगपाँचे *nagpāñche*, 1445.
 नगर *nagar*, 1416.
 नगर बिसराँव *nagar bisrañv*, 1416.
 नगर मोथा *nagar motha*, 1381.
 नगला *nagla*, 226.
 नँगोट *nangot*, 726.
 नँगोटा *'nangota*, 726.
 नघुरी *naghuri*, 768.
 नङ्गर *nangar*, 1130.
 नचनी *nachni*, 363 (13).
 नखतर *nachhattv*, 967, 1082.
 नङ्गनाट *nachhunāc*, 1326.

- नजर *najar*, 69, 813.
 नजर गुजर *najar gujar*, 69.
 नजर गोजर *najar gojar*, 69.
 नजर बाग *najar bāg*, 813.
 नजराना *najrāna*, 1201.
 नटंबाज *nathāj*, 585 (*f*).
 नटंबा *nathā*, 353, 501, 1099.
 नटाइ *natāi*, 501.
 नटुआ *nathua*, 1154, 1358.
 नट्टहि *nathahi*, 1084.
 नठहर *nathahar*, 1117:
 नत्ती *natti*, 353.
 नथ *nath*, 763.
 नथिया *nathiya* 236, 763, 936.
 नथियारी *nathiyāri*, 936.
 नथुनी *nathuni*, 763.
 नदंबा *nadhwa*, 308.
 नदंबा *nadha*, 365.
 नदिया *nadiya*, 138, 139, 713,
 1088.
 नदी *nadi*, 655.
 नदोइ *nadoi*, 141, 713, 719.
 नद्दी *naddi*, 916, 954.
 नधना *nadhna*, 276.
 नधान *nadhān*, 116, 276.
 ननकटनी *nankatni*, 875.
 ननकिरवा *nankirwa*, 1099.
 ननद *nanad*, 1402.
 ननंबाइ *nambāi*, 445.
 ननमुहिया *nanmuhiya*, 499.
 ननिआरा *naniaura*, 1298.
 ननिहर *nanihar*, 1298.
 ननिहार *nanihār*, 1298.
 ननिहाल *nanihāl*, 1298.
 नन्हकटनी *nanhkatni*, 875.
 नन्हिया *nanhya*, 972, 985.
 नन्हिया जनेरा *nanhya jānera*, 985.
 नपन्ही *naphi*, 378.
 नपाली *napāli*, 1057.
 नपर *naphar*, 844.
 नफा *napha*, 1475.
 नवग्रह *nabgrah*, 767.
 नवात *nabāt*, 1389, 1390.
 नवात चूनब *nabāt chūnab*, 158:
 1390.
 नबेर *naber*, 419.
 नबेरी *naberi*, 419.
 नमेर *namer*, 419.
 नम्हेर *namher*, 861.
 नम्हेरो *namhero*, 861.
 नया *naya*, 740.
 नर *nar*, 381, 472, 978, 102:
 1034.
 नरकट *narkat*, 815.
 नरकटाइ *narkatāi*, 1490.
 नरकटिया *narkatiya*, 985.
 नरकान *narkān*, 815.
 नरगोरी *nargori*, 1005.
 नरगा *nareha*, 1034, 1183.
 नरगा *narja*, 462.
 नरगजौक *narjonk*, 1183.
 नरगदोह *nardoh*, 270.
 नरगपुर *narapur*, 1025.
 नरम *narām*, 786.
 नरमा *narma*, 1016.
 नरगद्वी *narhāni*, 1030.
 नरही *narhi*, 1257.
 नरहु *narhu*, 996.
 नरहो *narho*, 996.
 नराउँ *narāün*, 510.
 नरियर *narigar*, 472.
 नरियरवाला *narigarwāla*, 471.
 नरियरी *narigari*, 715.
 नरियाल *narigāl*, 472.
 नरी *narī*, 363, 529, 567, 570.
 नरवा *narua*, 990, 1183.
 नरै *narai*, 1183.
 नरैली *naraili*, 17.
 नरोइ *naroi*, 814.

नरोई *narōi*, 814.
 नरोह *naroh*, 253, 270.
 नरोही *narohi*, 270.
 नरोष्ठा *naraua*, 510, 545.
 नल *nal*, 381.
 नल्ला *nalla*, 585.
 नव *naw*, 814.
 नव गकुली *naw gachhuli*, 814.
 नवघर *nawghar*, 2, 29.
 नवगटा *nawtha*, 2, 825.
 नवगटा के जोत *nawtha ke jot*, 825.
 नवत *nawat*, 1344.
 नवन्ता *nawta*, 645.
 नव पेड़ा *naw pera*, 814.
 नवहरा, *nawahra*, 825.
 नवाद *nawād*, 981.
 नवाद खेत *nawād khet*, 981.
 नविष्णखानी *nawishakhāni*, 1040.
 नस *nas*, 1023.
 नह *nah*, 153, 1349.
 नहकटिया *nahkatiya*, 1326.
 नह च्हाद *nah chhachhāi*, 1349.
 नहकुष्ठा *nahchhua*, 1326.
 नहकुष्ठा नहावन *nahchhua nahāvan*, 1326.
 नहच्छ *nahchhu*, 1313, 1314, 1326.
 नहट्टङ्गी *nahṭṭāṅgi*, 1326, 1403, 1411.
 नहर *nahar*, 916.
 नहरन *nahran*, 383.
 नहरनी *naharni*, 383, 470, 1030.
 नहल्ला *nahlla*, 422.
 नहवाप्रब *nahwāpab*, 1418.
 नहस *nahas*, 1454.
 नहाइ *nahāi*, 526.
 नहावन *nahāvan*, 1326, 1402.
 नहिँ *nahīñ*, 235, 250, 363, 393, 548, 990, 1088, 1090, 1272.
 नहिरा *nahira*, 1297.
 नहोँ *nahōñ*, 29.

नहेरि *naheri*, 383.
 ना *na*, 356, 1020, 1090, 1234, 1451, 1477.
 नाउ *nāu*, 383.
 नाउक *nāuk*, 1456.
 नाउक माहेब *nāuk sāheb*, 1156.
 नाओ *nāo*, 1088.
 नाक *nāk*, 346.
 नाग *nāg*, 1445, 1456.
 नाँगनी *nāngni*, 7.
 नाग पक्षमी *nāg pa. hmi*, 1445.
 नागपुर *nāgpur*, 1025.
 नागल्ला *nāgla*, 226.
 नागिन *nāgin*, 1456.
 नाटा *nāta*, 149, 261, 1096, 1099.
 नाटा बैल *nāta bail*, 261.
 नाठा *nātha*, 1157.
 नाड़ा *nāra*, 1381, 1384, 1391.
 नाड़ा *nāra*, 1109.
 नाथ *nāth*, 112, 261, 1234.
 नाद *nād*, 92, 284, 309, 365, 430, 586, 713, 924.
 नाँद *nāñd*, 92, 314, 316, 430.
 नादा *nāda*, 365.
 नादी *nādi*, 304, 1173.
 नादी कनवा *nādi kanwa*, 1173.
 ना देहन *na dehan*, 1477.
 ना देहन्द *na dehand*, 1477.
 नाध *nādh*, 276.
 नाधन *nāadhan*, 258, 276.
 नाधब *nādhab*, 817.
 नाध बरन्ता *nādh bartā*, 276.
 नाधा *nādha*, 17, 116, 277, 930.
 नाधा बरन्ता *nādha bartā*, 279.
 नानंपज *nānpaj*, 445.
 नानंवाद *nānbāi*, 445.
 नानीचाल *nānihāl*, 1298.
 नाप *nāp*, 1028.
 नापा *nāpa*, 378.
 नापी *nāpi*, 1028.

- नाफा *nāpha*, 1475.
 नाब *nāb*, 75.
 नाबूद् *nābūd*, 912, 1230.
 नाम *nām*, 1463a, 1485.
 नाम घेरल गैल *nām gheral gail*, 1485.
 नामज्जद *nāmjaḍ*, 1486.
 नामा *nāma*, 1488.
 नार *nār*, 75, 60, 90, 655, 894, 990,
 1183, 1259, 1400, 1401, 1408.
 नारकटाइ *nārkatāi*, 1400.
 नारग्री *nārgi*, 318.
 नारङ्गी *nāraṅgi*, 1043.
 नारन *nāran*, 17, 277.
 नार पुरैन *nār purain*, 1401.
 नारा *nāra*, 743, 990, 1183.
 नारी *nāri*, 90, 315, 529, 570, 798,
 836, 954, 1006, 1008.
 नारी के ऊख *nāri ke ūkh*, 1008.
 नरैनी *nārāini*, 1429.
 नाल *nāl*, 585.
 नालकी *nālki*, 241.
 नालबन्द *nālband*, 387.
 नाला *nāla*, 792.
 नाली *nāli*, 315, 532.
 नाव *nāv*, 229.
 नाँव *nānv*, 1463a and b.
 नाशन्ता *nāshṭa*, 1265.
 नास *nās*, 9, 1023.
 नास पाल *nās pāl*, 585.
 नासा *nāsa*, 9.
 नाह *nāh*, 153.
 नाहा *nāha*, 153.
 नाहक *nāhuk*, 356.
 नाहूँ *nāhū*, 829, 964, 1084, 1091.
 निकसब *niksab*, 1486.
 निकसार *niksār*, 1249.
 निकसारी *niksāri*, 1175.
 निकप्रब *nikāḍb*, 867.
 निकाल *nikāla*, 1085.
 निकारन *nikāran*, 867.
 निकास *nikās*, 1249.
 निकासब *nikāsab*, 1486.
 निकासल *nikāsāl*, 1098.
 निकाह *nikāh*, 1273, 1279, 1382.
 निकौरिया *nikauriya*, 1070.
 निकौनी *nikāuni*, 865, 869.
 निक्री *nikri*, 644.
 निखारल *nikhāral*, 391.
 निखुराह *nikhurāh*, 1146.
 निखोराह *nikhorāh*, 1146.
 निंगन्हा *ninghha*, 1457.
 निंगन्हा छोरी *ninghha chhori*, 1457
 निगर्दन *nigrān*, 954.
 निगस्ता *nigasta*, 1258.
 निगाली *nigāli*, 472, 1034.
 निगिहरी *nigihri*, 768.
 निघास *nighās*, 896, 983, 1145.
 निघेस *nighes*, 896, 1079.
 निघेसा *nighesa*, 983.
 निचिन्त *nichint*, 572.
 निचिराकी *nichirāki*, 796.
 निहत्तर *nichhatṭr*, 1082.
 निहरब *nichharab*, 391.
 निहाउर *nichhāur*, 1347.
 निहावर *nichhāvar*, 1347, 1402.
 निहावर करब *nichhāvar karab*, 1402
 नित्ती *nitti*, 641.
 निदान *nidān*, 1085.
 निपनिथाँ *nipanīyān*, 801.
 निबन्दा *nibra*, 319i.
 निबद्दर *nibaddar*, 1091.
 निमक *nimak*, 1407.
 निमक चसी *nimak chasi*, 1407.
 निमगौरिद *ningīriḍ*, 403, 418.
 निमदण्डा *nimdaḍḍa*, 228.
 निमन्डा *nimra*, 319i.
 निमन्दस्ता *nimdaṣṭa*, 706.
 निमाड़ *nimār*, 392.
 निमारा *nimāra*, 154.
 निमास्तौन *nimāstun*, 729.

निघाज *niyāj*, 1408, 1414.
 निघाज करब *niyāj karab*, 1408.
 निघरिया *niyariya*, 542.
 निघार *niyār*, 542.
 निघार धौषा *niyār dhau*, 542.
 निघारा *niyāra*, 543.
 निघारिया *niyāriya*, 542.
 निरख *nirakh*, 1488.
 निरख नामा *nirakh nāma*, 1488.
 निरखन *nirachchhan*, 1322.
 निरखन *nirchhan*, 1322.
 निरबीज *nirbāj*, 859.
 निरम्मल *nirmal*, 1091.
 निरारी *nirāri*, 939.
 निरिखन *nirichchhan*, 1322.
 निरेखब *nirekhab*, 1322.
 निरोह *niroh*, 251, 253, 270.
 निर्विज्ज *nirvijj*, 1078.
 निर्बीज *nirbīj*, 1078.
 निशकरन्दा *nishkarda*, 587.
 निसम्बत *nisbat*, 1285, 1361.
 निसुआ *nisua*, 286.
 निसुहा *nisuha*, 91, 286.
 निसार *nistar*, 427.
 निहाइ *nihāi*, 408, 526, 539, 549.
 नीच *nich*, 1217.
 नीपे *nipe*, 1267.
 नीम, *nim*, 1402.
 नीम धूरी *nim dhūri*, 154.
 नीमन *nīman*, 741.
 नीमा *nīma*, 729, 1074.
 नील *nil*, 1038.
 नुङ्गा *nuṅga*, 723.
 नुण्डा *nunda*, 710.
 नुगा *nūga*, 723, 740.
 नुंगा *nūnga*, 723.
 नुङ्गा *nūnra*, 121, 710.
 नुङ्गो *nūro*, 710.
 नेचरन्धरया *neardharua*, 1292.
 नेचार *neār*, 1292, 1319.

नेचारा *neāra*, 543.
 नेगन्डा *nengra*, 302.
 नेटन्वा *netwa*, 501.
 नेटुआ *netua*, 652, 1154.
 नेतुआँ *nemūān*, 1069.
 नेबान *nebān*, 877.
 नेबारा *nebāra*, 154.
 नेमान *nemān*, 1090, 1438.
 नेरुआ *nerua*, 990.
 नेबन्कावर *nebhāwā*, 1317.
 नेवन्तहर *newāhar*, 292.
 नेवन्ता *newta*, 145, 645, 1426, 1314.
 नेवन्ता *newta*, 1344.
 नेवन्तठ *newāth*, 389.
 नेवान *newān*, 877, 1438.
 नेवानी *newāni*, 1438.
 नेवार *newār*, 1073.
 नेवारी *newāri*, 894, 1183.
 नेवाला *newāla*, 1271.
 नेहनी *nehni*, 470, 512, 555.
 नेहरा *nehra*, 1297.
 नेहाइ *nehāi*, 408.
 नेहाइक *nehāik*, 408.
 नेहाए *nehāe*, 526, 549.
 नेहाय *nehay*, 560.
 नेहाली *nehāli*, 731.
 नेउन *nean*, 1160, 1166.
 नेकी बीबी *neki bībī*, 1158.
 नेग *neg*, 912, 1198, 1460.
 नेठो *neṭha*, 652.
 नेहा *nehā*, 984.
 नेहा *nehā*, 1074.
 नेत *net*, 145.
 नेतो *neto*, 145.
 नेन *nen*, 1166.
 नेनू *nenū*, 1160, 1166.
 नेफा *nepha*, 743.
 नेव *ne*, 1251.
 नेवन *newat*, 145, 645.
 नेचरैतिन *nehraitin*, 1277.

नैचा *naicha*, 473.
 नैचाबन *naichāban*, 474.
 नैचाबन्द *naichaband*, 474.
 नैजा *naija*, 1376.
 नैनु *nainu*, 1160.
 नैया *naiya*, 229.
 नैहर *naihar*, 1297.
 नोकन्ता *nokta*, 97.
 नोचिया *nōchīya*, 1198.
 नोनहराह *nonchharah*, 816.
 नोनिया *nonīya*, 713.
 नोनियाँ *noniyān*, 365, 1431.
 नोनियारी *noniyāri*, 816.
 नोनियाह *noniyāh*, 816.
 नोह *noh*, 1349.
 नोह हिलाह *noh chhīlāi*, 1349.
 नोहट्टुगार *nohtangār*, 1403.
 नोहट्टुङ्गी *nohtungji*, 1403.
 नोकर *nokar*, 740, 844, 1181.
 नौचा *nocha*, 1198, 1200.
 नोचे *noche*, 356.

नोनी *noni*, 816, 1003.
 नोनी चारी *nonihāri*, 44.
 नौकेड़ा बगौचा *naukeṛa bagūcha*, 8
 नौखील *naukhīl*, 981.
 नौगाही *naugāhī*, 814.
 नौराही *naurāhi*, 814.
 नौसत्ता *nūsatta*, 905, 906.
 नौह छिल्ली *nauh chhilli*, 1349.
 नौ *nau*, 363, 741, 975, 1070, 112
 नौसा *naua*, 383, 1204, 1286.
 नौसा ब्राह्मन *naua brāhman*, 1286.
 नौठ *nauthat*, 1246.
 नौठ वरब *nauthat karab*, 1246.
 नौठा *nautha*, 2.
 नौ धारा *nau dhāra*, 975.
 नौनगा *nānuga*, 767.
 नौपहस *nūpancham*, 1236.
 नौरतन *nūratan*, 1236.
 नौशे *nauše*, 1281.
 नौसत *nūsāt*, 905, 906.

॥ प ॥

पदला *paila*, 24.
 पदे *pāi*, 1017.
 पटना *paṭna*, 98.
 पट्टला *paṭla*, 24.
 पकण्डाइल *pakthāil*, 984
 पकड़न्ता *pakarta*,
 पकड़ि *pakari*, 568.
 पकमान *pakmān*, 1272.
 पकवान *pakvān*, 1272
 पकव्राह *pakvāh*, 293.
 पकसी *paksi*, 375.
 पकन्हा *pakha*, 789.
 पकुशा *pakusa*, 1023.
 पकुसी *pakusi*, 375.
 पक्का *pakka*, 920, 1235, 1263, 1495.
 पक्का बिगन्हा *pakka bigha*, 1495.
 पक्खन *pakkan*, 1074.
 पक्खी *pakhi*, 1074.

पख *pakh*, 1081, 1088
 पखन्डी *pakhari*, 414.
 पखन्नीरी *pakhnari*, 363.
 पखनी *pakhi*, 898.
 पखन्वीर *pakhvīr*, 363.
 पखरुचा *pakharua*, 1344.
 पखारी *pakhāri*, 1344.
 पखिया *pakhiya*, 1074.
 पखुरी *pakhuri*, 543.
 पखचार *pakhāṛ*, 363
 पखेव *pakheo*, 1119.
 पखेवा *pakheva*, 1119.
 पगन्डा *pagra*, 120, 533, 1010, 10
 पगन्डी *pagri*, 533, 724, 912, 1126
 पगन्डी ठसा *pagri thasa*, 533.
 पगन्डी बन्हाउब *pagri banhāb*, 1126.
 पगरन्वाह *pagarwāh*, 292.
 पंगरन्वाह *paṅgarwāh*, 292

- पगन्धा *pagha*, 108, 261, 1234.
 पगरी *pagri*, 724.
 पगार *pagār*, 1010, 1012.
 पगिया *pagiya*, 724.
 पगुरी *paguri*, 1011.
 पगुरी *paguri*, 1143.
 पगुरी करब *paguri karab*, 1143.
 पंगौरा *paugaura*, 308.
 पघरिया *paghariya*, 73.
 पघरया *pagharua*, 73.
 पघुराएब *paghurāeb*, 1143.
 पघुरी *paghuri*, 1143.
 पघुरी करब *paghuri karab*, 1143.
 पङ्क *pank*, 788, 789.
 पङ्का *pankha*, 414, 529.
 पङ्की *pankhi*, 225, 414, 529, 975,
 1256.
 पङ्गत *pangat*, 1450.
 पङ्गत *panghat*, 1341.
 पंच अग्नि *panchagin*, 1419.
 पंचधनी *panchani*, 1479.
 पंचआगि *panchāgi*, 1419.
 पंचकुख *panchukh*, 1437.
 पंचकटेल *panchkatail*, 787.
 पचकटा *panchkatta*, 1074.
 पचकठिया *panchkathiya*, 348, 1419.
 पचकरमा *panchkarma*, 1419.
 पचका *pankha*, 1428.
 पचकाठ *pankkāth*, 1419.
 पचकाठी *pankkāthi*, 1419.
 पचकण्डी *pankhandi*, 768.
 पचका *pankha*, 76.
 पचकाँड *pankhhānr*, 1437.
 पचका *pankhi*, 1024.
 पचगाोटिया *panchgotiya*, 984.
 पचघन *panchghan*, 1439.
 पचड़ी *panchri*, 11, 401.
 पचदू *panchdu*, 908.
 पचदू *panchdu*, 908, 909.
 पचनी *panchni*, 319i.
 पंचपातर *panchpātar*, 775.
 पंचपिष्ठा *panchpinda*, 1421.
 पंचपिरिया *panchpiriya*, 1456.
 पचफरिया *pachphariya*, 37.
 पंचमंगरा *pachmangra*, 1305.
 पचरावन *pachrāwan*, 1194.
 पचरी *pachri*, 331.
 पचरूखी *pachrūkhi*, 956.
 पंचरूखी *panchrūkhi*, 585.
 पंचलकन्डा *panchlakra*, 172.
 पंचलकड़ी *panchlakri*, 1419.
 पचलरी *pachlari*, 765.
 पचहली *pachhatthi*, 737.
 पंचारत *panchāith*, 1435.
 पंचारत *panchāit*, 1450.
 पंचारत सँ काठ देब *panchāit sēñ kāt
 deb*, 1452.
 पचाँटी *pachānti*, 1435.
 पचाड़ *pachār*, 1114.
 पचार *pachār*, 938.
 पचास *pachās*, 823.
 पंचीत *panchit*, 1450.
 पचे *pache*, 1272.
 पंचेता *pancheta*, 1450.
 पंचैतो *panchaiti*, 1450.
 पचौथाँ *pachhauān*, 801.
 पंचौख *panchowkh*, 1437.
 पंचौट *pachhaut*, 831.
 पचड़ *pachchar* 164, 157, 401.
 पचर *pachchar*, 157, 179.
 पचा *pachha*, 908.
 पचा दुषा *pachcha dūn*, 908.
 पचही *pachchi*, 157, 401, 485.
 पच *pachch*, 1081.
 पचखी *pachkhi*, 1011.
 पचनिहार *pachhnihār*, 1030.
 पचनिहारिन *pachhniharin*, 1030.
 पचलकड़ *pachhlakra*, 172.
 पचलगवा *pachhlagwa*, 1279.
 पचवा *pachhwa*, 1087, 1088.

पक्षर *pachhar*, 614.
 पक्षरु *pachhar*, 113, 614, 932.
 पक्षरी *pachhari*, 366.
 पश्चिमा *pachhima*, 1088.
 पश्चिमी *pachhiyāri*, 1005.
 पक्षुषा *pachhua*, 181, 558, 614, 726,
 900, 912, 914, 1483.
 पक्षुषार *paçhuuār*, 1237
 पक्षुषारा *pachhuāra*, 1237.
 पक्षुत *pachhūt*, 1245.
 पक्षुत के ठाट *pachhūt ke thāt*, 1245.
 पक्षुषा *pachhea*, 1087, 1092.
 पक्षुष्णा *pachherna*, 172.
 पक्षुलिया *pachheliya*, 768.
 पक्षुद *pachher*, 932.
 पक्षुला *pachhela*, 363, 558, 768.
 पक्षुली *pachholi*, 125.
 पक्षुटा *pachhauta*, 335c.
 पक्षुरा *pachhaura*, 614.
 पञ्जनी *panjani*, 168, 203.
 पञ्जवाहा *pañjāha*, 292.
 पञ्जार *pañjāi*, 1263.
 पञ्जावा *pañjāva*, 1264.
 पञ्जियार *pañjiyār*, 1354.
 पञ्जौर *pañjaur*, 1194.
 पञ्जौरा *pañjaura*, 1196.
 पञ्चक *pañchak*, 1428.
 पञ्चमी *pañchami*, 1445.
 पञ्चा *pañja*, 274.
 पट *pat*, 843.
 पटकन *patkan*, 477, 654.
 पटकी *patki*, 1004
 पटदेहर *patdehar*, 1251
 पटदेहल *patdehal*, 1251.
 पटन *patna*, 625, 1486.
 पटपर *patpar*, 788, 901.
 पटपरौ *patpari*, 793.
 पटमौरी *patmauri*, 1326.
 पटरा *patra*, 222, 414, 457, 467,
 635.

पटराची *patrahi*, 1001.
 पटरी *patri*, 248, 587, 600, 76
 1262.
 पटल *patal*, 878.
 पटवटन *patwatan*, 233, 367.
 पटवा *patwa*, 496, 768.
 पटवार *patwār*, 236.
 पटवारी *patwāri*, 1198.
 पटवासी *patwāsi*, 1326.
 पटवे *patve*, 30.
 पटवा *patha*, 389.
 पटवाँ *patahuāñ*, 801, 1240.
 पटहेरा *pathera*, 496.
 पटहेरी *patheri*, 496.
 पटा *puta*, 1001.
 पटार *patāi*, 233.
 पटाब *patāb*, 915, 1006.
 पटाबल *patāb*, 850, 1001.
 पटाबोल *patāb*, 801.
 पटाखा *patākha*, 585f.
 पटाही *patāhi*, 1074.
 पटान *patān*, 915.
 पटा लागत बा *patā lāgat ba*, 1001.
 पटावन *patāvan*, 915, 1006, 1007
 पटिदार *patilār*, 1214.
 पटिदारी *patidāri*, 1214.
 पटिया *patiya*, 213, 248, 467, 73
 889, 1265.
 पटिहर *patihar*, 915.
 पटील सोज *patil soj*, 711.
 पटुषा *patua*, 1047, 1073.
 पटुबाज *patubāj*, 585f.
 पटेर *pater*, 815.
 पटेली *pateli*, 230.
 पटवारी *patewāri*, 1468b.
 पटेली *patavli*, 230, 233.
 पटोर *patoī*, 1074.
 पटोलन *patolan*, 1262.
 पटौषा *patava*, 801, 1039, 1211
 1482.

- पटौना *pataunān*, 1210.
 पटौरे *patauri*, 801.
 पटौना *patauna*, 801.
 पटौनी *patauni*, 915.
 पटौरी *patauri*, 233.
 पट्टा *patta*, 11, 128, 213, 317, 574, 1471.
 पट्टी *patti*, 213, 243, 502, 638, 748, 1214.
 पट्टा *pattha*, 1125, 1129.
 पठरा *pathra*, 1125.
 पठरू *pathru*, 1122, 1123.
 पठवनिथा *pathvaniya*, 1295.
 पठिया *pathiya*, 889, 1122.
 पड़रुहि *parruhi*, 1120.
 पड़रू *parru*, 1120.
 पड़ाक *parāk*, 170, 172.
 पड़ाका *parāka*, 585f.
 पड़े *pare*, 393.
 पडिया *parhiya*, 745.
 पडित *pandit*, 572.
 पतई *patāi*, 1010.
 तंकड़ा *patkalla*, 1074.
 पतनारी *patnāri*, 271.
 पतनी *patni*, 880, 1211.
 पतनीदार *patnidār*, 1211.
 पतर *patr*, 1085, 1343.
 पतरपारा *patarpāra*, 292.
 पतरस *patras*, 1010.
 पतरौरी *patri*, 721, 1343, 1487.
 पतरौरी *patrauri*, 721.
 पतलगुष्ठा *patlagua*, 1004.
 पतलगु *patlaggu*, 1004.
 पतला *patla*, 136, 858.
 पतलार *patlār*, 1183.
 पतलो *patlo*, 1010.
 पतवार *patwār*, 236.
 पथर *pathar*, 120, 1010.
 पतहूल *pathūl*, 1010.
 पतहोल *pathol*, 1010.
 पता *patā*, 1024.
 पता तूरव *patā tūrab*, 1024.
 पतारा *patāra*, 1457.
 पताल *patāl*, 1101.
 पताल सिङ्घी *patāl singhi*, 1101.
 पताली *patāli*, 1101, 1113.
 पतिया *patiya*, 1018.
 पतियाण्ड *patiyāṅḍ*, 1018.
 पतियार *patiyār*, 236.
 पंतियारी *paṅtiyāri*, 214.
 पतिली *patīli*, 668.
 पती *pati*, 1274.
 पतील *patīl*, 858.
 पतीला *patīla*, 711, 713.
 पतीली *patīli*, 448, 711.
 पतुकी *patuki*, 139, 713.
 पतैन *patāin*, 235, 1010.
 पतौड़ी *patāuri*, 880.
 पतौतन *patāuntan*, 1210.
 पतौर *pataur*, 873, 880.
 पतौरा *pataura*, 984, 1010, 1073, 1272.
 पत्तन *pattan*, 880.
 पत्तर *patthar*, 178, 268.
 पत्तल *patthal*, 721, 1029, 1422.
 पत्ता *pattha*, 21, 404, 721, 764, 1462.
 पत्ती *patti*, 125.
 पत्थर *patthar*, 565, 593, 1080, 1265.
 पथल *patthal*, 404, 565, 1080, 1265.
 पत्र *patra*, 1354.
 पत्री *patri*, 1344, 1487.
 पथरटिया *pathratiga*, 786.
 पथरी *pathri*, 565.
 पथरेहर *pathrehar*, 794.
 पथरौठी *pathrauti*, 769, 786, 794.
 पथरौर *pathraur*, 853.
 पथल *pathal*, 318, 389, 104, 549, 1087.
 पथाना *pathāna*, 638.
 पथार *pathār*, 832.

- पथारी *pathāri*, 853, 880.
 पथिया *pathiya*, 39, 43, 93, 288.
 पथुचा *pathua*, 1262.
 पथुली *pathuli*, 44.
 पथौनी *pathauni*, 638.
 पटुका *paduka*, 585.
 पंटेनी *pandeni*, 551.
 पन *pan*, 854.
 पनकाठी *pankāthi*, 551.
 पनकी *panki*, 854.
 पनगण्डा *panganda*, 1007.
 पनगिजा *panginja*, 1263.
 पनचटी *pancharhi*, 1287.
 पनचाहा *panchāha*, 419.
 पनचोरा *panchora*, 713.
 पनचही *panchhatti*, 1245.
 पनचहन्दा *panchhanda*, 915.
 पनचहना *panchhanna*, 915, 945.
 पनचहनी *panchhāni*, 1005.
 पनचहोर *panchhor*, 115, 116, 930.
 पनचोही *pantohi*, 1287.
 पनचठिया *panduthiya*, 1021.
 पनचडूबी *pandūbi*, 1458.
 पनचदान *pandān*, 708.
 पनचपिचौचा *panpiaua*, 884.
 पनचपियाइ *panpiyāi*, 1268.
 पनचपियार *panpiyār*, 1268.
 पनचपियाव *panpiyāo*, 1268.
 पनचबटा *pambatta*, 660, 708, 711.
 पनचबट्टी *pambatti*, 660, 1285.
 पनचभरा *panbhara*, 915.
 पनचभारा *panbhāra*, 915.
 पनचमार *panmār*, 789.
 पनचमारा *panmāra*, 721.
 पनचमोरन्वाह *panmorwāh*, 915.
 पनचमोरा *panmora*, 945.
 पनचवा *panwa*, 767.
 पनचवाला *panwāla*, 553.
 पनचसचा *pansacha*, 923.
 पनचसारी *pansāri*, 966a, 1005.
 पनचसाहा *pansāha*, 969.
 पनचसाही *ansāhi*, 1005.
 पनचसुही *pansūhi*, 231.
 पनचसेरा *pansera*, 1500.
 पनचसेरी *panseri*, 1500.
 पनचसेल *pansel*, 923.
 पनचखटा *pankhanda*, 419, 465.
 पनचही *panahi*, 735.
 पना *pana*, 711.
 पनार *panār*, 365.
 पनाह *panāh*, 711.
 पनिसागर *paniāgar*, 1252.
 पनिसाग्रल *paniyāēl*, 915.
 पनियोचा *paniyocha*, Appendix, 10
 पनियोले *paniyaulēñ*, 1217.
 पनिवाह *panivāh*, 915.
 पनिचण्डा *panihanda*, 419.
 पनिचता *panihata*, 963.
 पनिहा *paniha*, 922.
 पनिहारा *panihāra*, 419, 915.
 पनिहौवा *panihauwa*, 1064.
 पनुचौ *panuāñ*, 1272.
 पनौटी *panauti*, 660.
 पनौला *panaula*, 801.
 पन्थ *panth*, 1073.
 पन्ना *panna*, 1462.
 पन्निक *pannik*, 363.
 पन्निक *pannikh*, 363.
 पन्नी *panni*, 363, 567.
 पपरा *papra*, 1133, 1272.
 पपरी *papri*, 860.
 पपन *paban*, 1437.
 पपन परिचहा *paban parichchha*, 14
 पपन्दी *panri*, 1037.
 पप्ली *pambhi*, 898.
 पर *par*, 393, 1088, 1394, 145
 1478, 1485.
 परकट्टो *parkattho*, 91, 404, 1141
 परकठ *parkath*, 286, 408.
 परकार *parkār*, 1056.

- परन्कास *parkāl*, 404, 419, 512, 519.
 परकिथा *parakiya*, 1272.
 परखण्डा *parkhanda*, 740.
 परखब *parkhab*, 1484.
 परखिया *parakhiya*, 1484.
 परखी *parkhi*, 1484.
 परगहन्नी *pargahni*, 532.
 पॅरगा *panrga*, 832, 83.
 परघनी *parghani*, 532.
 परघुई *parchūn*, 924.
 परघट्टी *parehhatti*, 1245.
 परघट्टी *parchhatti*, 1245.
 परघन *parehhan*, 1316.
 परघा *parehha*, 319i, 365, 713, 952.
 परघावन *parehhaavan*, 1316.
 परघांनी *parehhauni*, 1316.
 परजा *parja*, 1215.
 परजापत *parjāpat*, 572.
 परन्तर *partar*, 1028.
 परन्तहा *partaha*, 485.
 परन्ता *parta*, 353, 501, 797, 799, 1028.
 परन्ताहर *partāhar*, 292.
 परन्ताहा *partāha*, 485.
 परन्ती *parti*, 501, 797, 799, 912, 1147, 1229.
 परन्थन *parthan*, 630, 1272.
 परन्थनी *parthani*, 630.
 परन्दा *parda*, 216, 223, 246, 467.
 परन्धान *pardhān*, 1450.
 परन्निहार *parnihār*, 292.
 परन्नौहा *parnauha*, 365.
 परन्पेठ *parpeth*, 1487.
 परन्पेठ *parpānith*, 1487.
 परन्वत *parbat*, 1087.
 परन्वल *parbal*, 736.
 परन्मल *parmal*, 1272.
 परन्मान *parmān*, 1487.
 परन्वर *parwar*, 1073.
 परन्वल *parwal*, 736.
 परन्वसन्ती *parwasti*, 1209e.
 परन्वाच *parwāch*, 1428.
 परन्साद *parsād*, 975.
 परन्सोती *parsoti*, 787.
 परन्सौती *parsauti*, 1398, 1409, 1412.
 परन्सौती के कमाद *parsauti ke kamāi*, 1412.
 परन्हटा *parhata*, 91.
 परन्हडा *parhuttha*, 408.
 परन्वे *parve*, 48.
 पराद *parāi*, 713.
 पराप्रब *parāeb*, 1425.
 पराँठ *parānith*, 833.
 पराठा *parātha*, 1272.
 परात *parāt*, 460, 681, 797.
 पराँत *parānt*, 797.
 पराता *parāta*, 797.
 परास *parās*, 124, 234.
 परिच्छठ *pariath*, 91.
 परिकठ *parikath*, 91.
 परिख *parikh*, 1484.
 परिच्छा *parichchha*, 1437.
 परिहन *parichhan*, 1316.
 परिहावन *parehhaavan*, 1316.
 परिथा *pariya*, 713, 832.
 परिथाप्रब *pariyāēb*, 1115.
 परिथाठा *pariyātha*, 408, 404, 934.
 परिथानी *pariyāni*, 640.
 परिथेठा *pariyetha*, 286.
 परिहत *parihat*, 7.
 परिहथ *parihath*, 7.
 परिहार *parihar*, 872, 915.
 परिहार *parihār*, 1456.
 परीत *parit*, 797.
 परुचा *parua*, 436, 1098.
 परुई *parūi*, 436.
 परेखिया *parekhiya*, 1484.
 परेच *parech*, 1272.

- परेख *payekhab*, 1484.
 परेठा *paretha*, 408.
 परेता *pareta*, 353, 501.
 परेह *pareh*, 1001.
 परेठ *paraitha*, 91.
 परोसिया *parosiya*, 1113.
 परोधो *parodho*, 1205.
 परोर *parar*, 1073.
 परोरा *parora*, 1073.
 परोल *parol*, 1073.
 परोहन *parohan*, 393.
 परोहित *parohit*, 1347, 1402, 1422,
 1426.
 परौषा *paraundha*, 1205.
 पलई *palū*, 21.
 पलंगरी *palangri*, 636.
 पलंगियर *palangiya*, 636.
 पलङ्ग *palang*, 636.
 पलङ्गा *palanga*, 832.
 पलण्टा *patta*, 846.
 पलण्टी *patti*, 291, 846, 915, 872.
 पलण्डा *palra*, 641.
 पलण्ठी *palthi*, 1429.
 पलण्ठी बैसब *palthi baisab*, 1492.
 पलमरुआ *palmarua*, 1080.
 पलरा *palra*, 641.
 पलवल *palwal*, 1073.
 पलवार *palwar*, 232.
 पलहार *palhar*, 1010.
 पलाँ *palāū*, 402.
 पलाँकी *palānki*, 1073.
 पलान *palān*, 125, 126, 1131.
 पलानी *palāni*, 72, 1153, 1234,
 1245.
 पलिया *paliya*, 719.
 पलिहर *palihar*, 798, 802, 858.
 पलेथन *palethan*, 636, 1272.
 पला *palla*, 21, 35, 416, 739, 938,
 1080, 1092, 1245, 1249.
 पलो *pallo*, 1310, 1331.
 पल्लारी *palhāri*, 880.
 पवनी *pawani*, 1193.
 पवनी पसारी *pawani pasāri*, 1193.
 पवही *pawahi*, 914.
 पँवारी *pamwāri*, 29.
 पस *pas*, 1120.
 पसंगा *pasanga*, 643.
 पसंगी *pasangi*, 1398.
 पसंघा *pasangha*, 643.
 पसंघी *pasanghi*, 1398, 1400.
 पसन्नी *pasni*, 61, 1400.
 पसरा *pasra*, 646.
 पसराँइ *pansraū*, 1252.
 पसहिआ *pansahiya*, 1005.
 पसही *pasahi*, 882.
 पसार *pasār*, 363.
 पसारी *pasāri*, 1193.
 पसावन *pasāvan*, 1165.
 पसावा *pasāwa*, 1015.
 पसिन *pasin*, 978.
 पसुज *pasūj*, 748.
 पसेरी *paseeri*, 1204, 1500.
 पसेवा *pasewa*, 923, 1032.
 पसोइ *pasoi*, 923.
 पसौँइइ *pasauṅ*, 1252.
 पसौँता *pasauṅta*, 1183.
 पह *pah*, 795, 797, 799, 818, 904.
 पहनटा *pahta*, 832, 846.
 पहचाना *pahchāna*, 478.
 पह परती *pah parti*, 799.
 पहरवार *paharwār*, 842.
 पहरावा *pahrāwa*, 723.
 पहरुआ *paharua*, 610.
 पहरुक *pahrūk*, 1184.
 पहण्टा *pahta*, 424, 571.
 पहला *pahla*, 951.
 पहला गार *pahla gār*, 952.
 पहसुल *pahsul*, 74.
 पहास बर *pahās bar*, 1456.
 पहिया *pahiya*, 151, 1006.

- पहिषा वाला हर *pahiya wāla har*, 1006.
 पहिरे *pahire*, 1090.
 पहिरोप *pahirop*, 1435.
 पहिरोपा *pahiropa*, 1435.
 पहिल *pahil*, 818, 1007.
 पहिल चास *pahil chās*, 818.
 पहिल पटावन *pahil patāwan*, 1007.
 पहिला *pahila*, 1057, 1092.
 पहिला मँटी के बीया *pahila mānti ke biya*, 1057.
 पहिलोठ *pahiloṭh*, 1114.
 पहिलोठ or पहिलौठ गाय *pahiloṭh or pahilaunth gāy*, 1114.
 पहिलौठ *pahilaunth*, 1114.
 पहिलौठा *pahilautha*, 1397.
 पही *pahi*, 797.
 पङ्च *pahunch*, 1011, 1487.
 पङ्च परन्मान *pahunch parmān*, 1487.
 पङ्चारी *pahunchāri*, 757.
 पङ्ची *pahunchi*, 757, 768.
 पङ्चे *pahunche*, 1487.
 पङ्चे दाम *pahunche dām*, 1487.
 पाइ *pāi*, 362, 1497, 1499.
 पाइ करब *pāi karab*, 362.
 पाई *pāi*, 1218.
 पाइट *pāit*, 915, 1098.
 पाइट घुमाइब *pāit ghumāib*, 1098.
 पाइठ *pāeth*, 846, 872.
 पाइन *pāen*, 553.
 पाइर *pāūr*, 858.
 पाक *pāk*, 289.
 पाँक *pānk*, 788, 789.
 पाकल *pākal*, 1263.
 पाँकी *pānki*, 789, 898.
 पाके *pāke*, 965.
 पाख *pākh*, 1251.
 पाखा *pākha*, 1251.
 पाग *pāg*, 724, 1272.
 पाँगल *pāngal*, 875.
 पागुर *pāgur*, 1143.
 पागुर करब *pāgur karab*, 1143.
 पाँच *pānch*, 1138.
 पाचक *pāchak*, 1272.
 पाँच कलियान *pānch kaliyān*, 1138.
 पाँचख *pānchakh*, 76.
 पाचड़ *pāchar*, 11, 269.
 पाचर *pāchar*, 251, 269, 1251.
 पाँचा *pāncha*, 76.
 पाँचा दूसा *pāncha dūsa*, 909.
 पाँचे *pānche*, 1445.
 पाँचो *pāncho*, 723, 1456.
 पाँचो टुक कपड़ा *pāncho tūk kapra*, 723.
 पाँचो पीर *pāncho pīr*, 1456.
 पाकब *pāchhab*, 1030.
 पाका *pāchha*, 1087.
 पाहिल *pāchhil*, 1089.
 पाहू *pāchhu*, 1234.
 पाज *pāj*, 1143.
 पाज करब *pāj karab*, 1143.
 पाँजा *pānja*, 882, 884, 1013, 1194, 1196.
 पाँजी *pānji*, 1354.
 पाँजौ *pānjau*, 884.
 पाभा *pājha*, 1153.
 पाट *pāt*, 11, 389, 889, 940, 924, 1098.
 पाटल *pāta*, 29.
 पाट जोतब *pāt jōtab*, 1098.
 पाट लगारब *pāt lagāb*, 1098.
 पाटन *pātan*, 233.
 पाटना *pātna*, 233.
 पाटन्राला *pātwāla*, 889.
 पाटा *pāta*, 11, 317, 319m, 424.
 पाटी *pāti*, 243, 248, 626, 638, 738, 843.
 पाटो *pāto*, 11.
 पाठ *pāth*, 429, 889.
 पाठा *pātha*, 1122.

- पाठी *pāthi*, 1122.
 पाड़ *pār*, 1257.
 पाँड़र *pānrar*, 853.
 पाड़ा *pāra*, 1120.
 पाड़ी *pāri*, 1120.
 पाड़ *pārhi*, 429, 588, 1050.
 पाहि *pārhi*, 745.
 पात *pāt*, 764, 767, 868.
 पातन *pātan*, 880.
 पातर *pātar*, 858.
 पाता *pāta*, 21, 237.
 पाँता *pānta*, 814.
 पाती *pāti*, 655, 1090.
 पाँती *pānti*, 814, 857, 1050.
 पाथक *pāthak*, 1339.
 पाथब *pāthab*, 853.
 पाथर *pāthar*, 162, 858, 1080.
 पाथल *pāthal*, 853.
 पाथा *pātha*, 137, 146.
 पान *pān*, 767, 822, 1049, 1217, 1432.
 पान चास *pān chās*, 822.
 पानन्दार *pāndār*, 475.
 पान फूल *pān phul*, 1432.
 पानि *pāni*, 240, 1234, 1314.
 पानि तुरल *pāni tural*, 240.
 पानि तोड़ब *pāni torab*, 240.
 पानी *pāni*, 919, 922, 1007, 1090,
 1092, 1145, 1159, 1419.
 पानी देब *pāni deb*, 1419.
 पापर *pāpar*, 1272.
 पाँभी *pāmbhi*, 898.
 पाया *pāya*, 638, 1256.
 पार *pār*, 1113, 1205.
 पारखत *pārkhāt*, 777.
 पारन्चा *parcha*, 1370.
 पारस नाथ *pāras nāth*, 1456.
 पारब *pārab*, 865, 873.
 पारा *pāra*, 254, 1205.
 पारा पारी *pāra pāri*, 291.
 पारी *pāri*, 291, 436, 832, 872.
 पारीवाला *pāriwāla*, 1184.
 पारबती *pārbati*, 1443.
 पाल *pāl*, 238, 319m, 920c, 1115,
 1194, 1196, 1204.
 पाल पसेरी *pāl paseri*, 1204.
 पालठ *pāla*, 14.
 पालन्की *pālki*, 241, 1073.
 पालक *pālak*, 1073, 1209c, 1394.
 पाल खाणब *pāl khāēb*, 1115.
 पालठ *pālat*, 830.
 पाला *pāla*, 1080, 1249.
 पालो *pālo*, 14, 194, 938, 1308, 1333.
 पालो मोठन्हा *pālo motha*, 938.
 पाव *pāv*, 1500.
 पाँव *pāūv*, 771, 1341.
 पाँवजेब *pāūvejeb*, 771.
 पावट *pāwat*, 771, 939.
 पावन्ना *pāvanna*, 1488.
 पाँव पखारी *pāūv pakhāri*, 1341.
 पाँव सङ्कर *pāūv sankar*, 771.
 पावा *pāva*, 638, 1054, 1500.
 पावे *pāve*, 1088, 1486.
 पास *pās*, 29, 1050.
 पासँघ *pāsangh*, 643, 1484.
 पासँघ देखल *pāsangh dekhāl*, 1484.
 पासङ्ग *pāsang*, 60.
 पासा *pāsa*, 29, 866.
 पासो *pāsi*, 74, 115, 374, 638.
 पासो *pāso*, 29.
 पाही *pāhi*, 198, 1215, 1218.
 पाही कास *pāhi kāst*, 1218.
 पाहुर *pāhur*, 1125.
 पाहे *pāhe*, 1050.
 पिचरा *piara*, 1136.
 पिचरी *piari*, 1327, 1348.
 पिचनी *piuni*, 337.
 पिकन्दान *pikdān*, 707, 711.
 पिकन्दानी *pikdāni*, 707.
 पिकन्कड़ा *pichhkarā*, 172.
 पिकन्कड़ा *pichhkarā*, 172.

पिक्काड़ी *pichhāri*, 113.
 पिक्कूआ *pichhua*, 224, 726, 1483.
 पिक्कूआनी *pichhuāni*, 1237.
 पिक्कूआर *pichhuār*, 1237,
 पिक्कूआरा *pichhuāra*, 1237.
 पिक्कूत्ती *pichhutti*, 1237.
 पिक्कूत *pichhūt*, 1237.
 पिक्कौरा *pichhaura*, 740, 741.
 पिज्जवा *pijwa*, 1264.
 पिजावल *pijāval*, 25.
 पिजावा *pijāwa*, 1264.
 पिठग्ना *pitna*, 480.
 पिठग्नी *pitni*, 887.
 पिठावल *piṭāval*, 25.
 पिठोइ *pitoi*, 1074.
 पिठौआ *piṭāua*, 372, 713.
 पिठौर *pitaur*, 103.
 पिठ्ठा *piṭtha*, 1272.
 पिठ्ठी *piṭhī*, 1272.
 पिठार *piṭhār*, 1203, 1272, 1139.
 पिठिया *piṭhiya*, 126.
 पिंङ्गर *piṅgar*, 575.
 पिंई *piṅai*, 341.
 पिंइंसरि *piṅhsari*, 337.
 पिंइया *piṅhiya*, 176, 179, 182, 200,
 332, 457, 467, 487, 587, 623,
 634.
 पिंइरी *piṅhāri*, 575.
 पिंइर *piṅhar*, 575.
 पिण्ड *pind*, 919.
 पिण्डा *pinda*, 466, 1243, 1425,
 1426, 1427.
 पिण्डा पराग्रब *pinda parāgb*, 1425
 पिण्डी *pindi*, 775.
 पितरन्गेली *pitarseli*, 1073.
 पिनिक *pinik*, 1035.
 पिनौरी *pināuri*, 575.
 पिन्ना *pinna*, 1031.
 पिपरा *pipra*, 1075, 1185.
 पिपरा *piyara*, 1261.

पिषा *piya*, 1087.
 पिषाज *piyāj*, 1073.
 पिषादा *piyāda*, 871.
 पिषाला *piyāla*, 465, 711, 713.
 पिषाली *piyāli*, 711.
 पिरन्की *pirki*, 1179.
 पिरगन्दान *piragān*, 707.
 पिरगिठी *pirgithi*, 527.
 पिरन्ची *pirhi*, 487.
 पिरिकन्दान *pirikān*, 707.
 पिरित *pirit*, 914, 971, 1203.
 पिलण्डा *pilāṅḍa*, 466.
 पिलग्दी *pilāḍi*, 1171.
 पिलुआ *pilua*, 1074.
 पिल्लू *pillu*, 1074.
 पिसग्ना *pisna*, 625.
 पिसग्जन *pisvan*, 625.
 पिसाइ *pisāi*, 625.
 पिसान *pisān*, 625, 1055, 1272.
 पिहन्कर *pihkar*, 705.
 पिचिका *pihika*, 1074.
 पी *pi*, 1274.
 पीअनी *piāni*, 1023.
 पीअर *piar*, 1136.
 पीण *pi*, 1026.
 पीच *pih*, 1272.
 पीचर *pihar*, 965g.
 पीटन *pitān*, 575.
 पीटब *piṭab*, 391, 887.
 पीठा *piṭha*, 1272, 1378.
 पीठी *piṭhī*, 1272.
 पींङ्ग *piṅg*, 575, 268, 917, 953.
 पींङ्गा *piṅga*, 1251.
 पींङ्गी *piṅgi*, 775.
 पींहा *piṅha*, 332, 457, 467, 623,
 634.
 पींइ *piṅhi*, 634.
 पींही *piṅhī*, 623, 634.
 पीतर *piṭar*, 664.

- पीना *pīna*, 263, 1031.
 पीना खल्ली *pīna khalli*, 263.
 पीनी *pīni*, 337, 1023.
 पीबे *pībe*, 1166.
 पीयर *pīyar*, 1003, 1264.
 पीया *pīya*, 1274.
 पीर *pīr*, 337, 1376, 1456.
 पीर का नैजा *pīr ka naija*, 1376.
 पीरिच *pīrich*, 325.
 पीरिस *pīris*, 325.
 पीरी *pīri*, 1098, 1348.
 पीरी मेंजोतब *pīri meñ jotab*, 1098.
 पीरो *pīro*, 1074.
 पीला *pīla*, 1264.
 पुसरन्सी *puarsi*, 898.
 पुसरा *puara*, 894.
 पुसाड़ी *puāri*, 1009.
 पुसार *puār*, 894.
 पुसारी *puāri*, 1009.
 पुसारी के जोन *puāri ke jot*, 1009.
 पुस *pūs*, 817, 827.
 पुस धरब *pūs dharab*, 817.
 पुख *pukh*, 1082, 1086.
 पुच्छ *puchchh*, 726.
 पुच्छी *puchchhi*, 1285, 1343.
 पुच्छा *puchhra*, 614.
 पुछारी *puchhāri*, 1428.
 पुछारो *puchhāro*, 1428.
 पुक्षिया *puchhīya*, 614.
 पुक्केट *puchhet*, 335c.
 पुक्केटा *puchheta*, 335c.
 पुक्केटा *puchhanta*, 335c.
 पुजमाल *pujmāl*, 388.
 पुजार *pujāi*, 1198.
 पुंजोर *puñaur*, 890.
 पुंजी *puñji*, 1485.
 पुंठी *puñthi*, 152.
 पुनर *puñr*, 1394.
 पुनरा *puñra*, 957.
 पुनरुत्ता *puñra*, 67.
 पुतल्ली *putli*, 740.
 पुता *puta*, 990.
 पुनिया *putiya*, 1248.
 पुत्ता *putta*, 1248.
 पुत्ती *putti*, 344, 957, 990, 1248.
 पुदेना *puđena*, 1073.
 पुनरन्वस *puñarvas*, 967, 1082, 1088.
 पुनहर *puñhar*, 547.
 पुनु *puñu*, 719, 741 (footnote), 1488.
 पुपरा *pupra*, 1075, 1183.
 पुरजा *puñja*, 1464, 1480.
 पुरजी *puñji*, 1464.
 पुनन्वो *puñvo*, 1183.
 पुग्वा *puñva*, 1082.
 पुग्वा चाइ *puñva khāih*, 1082.
 पुग्वा फयुनी *puñva phayuni*, 1082.
 पुग्वट *puñvat*, 895.
 पुग्वा *puñva*, 1087, 1088.
 पुग्वे *puñve*, 819.
 पुग्वेश *puñveśa*, 1087, 1088.
 पुग्दिघा *puñdigha*, 1114, 1117.
 पुग्दिघा *puñdigha*, 1480.
 पुग्ख *puñkh*, 1274.
 पुग्खक *puñkhak*, 604.
 पुग्सी *puñsi*, 898.
 पुग्म *puñm*, 1401.
 पुग्रोहित *puñrohita*, 1347.
 पुग्रीना *puñrañta*, 1201.
 पुग्गा *puñga*, 894.
 पुग्गी *puñgi*, 585, 929.
 पुग्गटेल् *puñgtail*, 335c.
 पुग्गन्तङ्ग *puñgtang*, 226.
 पुग्गटे *puñgtai*, 1119.
 पुग्गन्तङ्ग *puñgtang*, 226.
 पुग्गी *puñgi*, 1248.
 पू *pū*, 1272.
 पूषा *pūśa*, 1272.
 पूंज *pūñj*, 890.
 पूजा *pūja*, 1319, 1420, 1434, 1442, 1442.

- पूंजी *pūñji*, 1485.
 पूंजी पट्टा *pūñji pattā*, 226.
 पूत *pūt*, 1043.
 पूतक *pūtāk*, 781.
 पूता *pūta*, 1248.
 पूती *pūti*, 344.
 पूर *pūr*, 1088, 1118, 1201.
 पूरन *pūran*, 1347.
 पूरब *pūrab*, 1082.
 पूरब भद्रपद *pūrab bhadrāpad*, 1082.
 पूरा *pūra*, 136, 1118, 1381, 1384.
 पूरि *pūri*, 1002n.
 पूरिस *pūris*, 923, 1493.
 पूरी *pūri*, 884, 1204, 1272, 1405.
 पूला *pūla*, 882, 894.
 पूस *pūs*, 1082, 1092.
 पूचाला *pūāla*, 713.
 पूकन्चा *pūkha*, 1061.
 पूकन्ची *pūkhi*, 1061.
 पूगन्नी *pūgnī*, 168, 203.
 पूचकस *pūchkas*, 325, 417.
 पूचन्दार *pūchdār*, 473.
 पूचवान *pūchwān*, 473, 475.
 पूटन्चली *pūchali*, 1171.
 पूटन्पचन्रा *pūchra*, 251.
 पूटन्पौञ्ज्या *pūchya*, 1397.
 पूटाढ़ा *pūtārha*, 585, 657.
 पूटाढ़ी *pūtārhi*, 657, 963, 1074.
 पूटार *pūtār*, 125, 657.
 पूटारन्ची *pūtārhi*, 1074.
 पूटारा *pūtāra*, 585c, 657.
 पूटारी *pūtāri*, 45, 657, 887, 963.
 पूटाही *pūtāhi*, 963.
 पूटौक *pūtūk*, 1171.
 पूंङ्गनी *pūñgī*, 63, 306.
 पूतावन *pūtāvan*, 1439.
 पूनेनी *pūnenī*, 551.
 पून्हाप्रल *pūnhāpral*, 1164.
 पूपन्ची *pūpchi*, 1001.
 पूयाज *pūyāj*, 1073.
 पूरन्मार *pūrmār*, 858.
 पूरन्वा *pūrnva*, 48.
 पूवन्नी *pūvni*, 337.
 पूशन्गी *pūshgi*, 1210.
 पूहन्ना *pūhna*, 79.
 पूहान *pūhān*, 79, 81.
 पूहानी *pūhāni*, 45.
 पूंच *pūch*, 325, 473, 726.
 पूचक *pūchak*, 498.
 पूट *pūt*, 251, 1465.
 पूटन्फुली *pūthullī*, 1176.
 पूटा *pūta*, 1465.
 पूटावाला *pūtwāla*, 1219.
 पूटी *pūti*, 261, 279.
 पूटे *pūte*, 1043.
 पूथ *pūth*, 1187.
 पूथा *pūtha*, 1272.
 पूथी *pūthī*, 872.
 पूरब *pūrab*, 264.
 पूड़ा *pūḍā*, 514, 1272.
 पूंद *pūnd*, 80.
 पूंदा *pūnda*, 80.
 पूंदी *pūndī*, 80.
 पूंदो *pūndo*, 80.
 पूना *pūna*, 98.
 पूनी *pūnī*, 80.
 पूरब *pūrab*, 264.
 पूलन *pūlan*, 486.
 पूवन *pūvan*, 738.
 पूवन्ट *pūvānt*, 738.
 पूकन्रा *pūkura*, 114.
 पूंजन्नी *pūñjī*, 771.
 पूंजनी *pūñjī*, 168, 169, 170, 203.
 पूठावी *pūthāvi*, 1043.
 पूताना *pūṭāna*, 638.
 पूसारी *pūsāri*, 1350.
 पूहन्टा *pūhnta*, 424.
 पूंकड़ *pūñkar*, 198.
 पूकर *pūkar*, 105, 114, 198, 1130.
 पूंकर *pūñkar*, 105, 114.

- पैकल *paikal*, 198.
 पैच *painch*, 846, 1476.
 पैचा *paincha*, 1476.
 पैचेदार *painchedār*, 727.
 पैजामा *paijāma*, 727, 746.
 पैटा *paita*, 424.
 पैठ *painth* 1487.
 पैठी *painthi*, 915.
 पैह *pairh*, 105.
 पैहा *pairhā*, 105.
 पैत्रिक *pairtrik*, 1299.
 पैदा *paida*, 1028.
 पैन *pain*, 836, 916, 954, 1489.
 पैना *paina*, 23, 98.
 पैनि *paṇi*, 836, 916, 954.
 पैया *paīya*, 967, 1074, 1076, 1086, 1088.
 पैर *pair*, 891, 892, 959, 1341.
 पैर पखरखा *pair pakharna*, 1341.
 पैर पखारी *pair pakhāri*, 1341.
 पैरा *paira*, 858, 959, 1096.
 पैरी *pairi*, 771.
 पैला *paila*, 24, 343, 398, 714, 914.
 पैस *pais*, 817, 827.
 पैस धरब *pais dharab*, 817.
 पैसा *paisa*, 1500.
 पैसे *paise*, 1479.
 पैसे रुपैया *paise rupaiya*, 1479.
 पैहार *paihār*, 1218.
 पोआर *poār*, 894, 963, 1183.
 पोआरी *poāri*, 1074.
 पोखन्ता *pokhta*, 1235.
 पोखन्ना *pokhna*, 916, 1379.
 पोखन्ना खोदब *pokhna khodab*, 1379.
 पोचारा *pochāra*, 1267.
 पोचारा बाला *pochāra wāla*, 1267.
 पोचन्नी *pochhni*, 1030.
 पौहन्वाखा *ponchlwāla*, 1109.
 पौहिया *ponchhiya*, 224.
 पोहुआ *pochhua*, 1272.
 पोथानी *pothāni*, 638.
 पोदीना *podina*, 1073.
 पोदेना *podena*, 1073.
 पोरन्नोवो *pornovo*, 1011.
 पोरन्सा *pora*, 923.
 पोराना *porāna*, 1010.
 पोरैया *poraiya*, 1114.
 पोलिया *poliya*, 353.
 पोसन्ता *posta*, 263, 1028.
 पोसन्पालक *pospālak*, 1394.
 पोसन्पुत *posput*, 1394.
 पोसन्बालक *posbālak*, 1394.
 पोसन्बेटा *posbeta*, 1394.
 पोसिया *posiya*, 1394.
 पोसिया लेब *posiya leb*, 1394.
 पोस्ता *posta*, 1183.
 पौहन्डा *ponhra*, 1008.
 पोआ *poa*, 1024.
 पोइ *poi*, 1009, 1010, 1017.
 पोकब *pokab*, 1171.
 पोखर *pokhar*, 916.
 पोखरौ *pokhari*, 916 (footnote).
 पौंगा *pongi*, 472.
 पोचो *pocho*, 984.
 पोहब *pochhab*, 1030.
 पौह्नी *ponchhi*, 614.
 पोट *pot*, 1073.
 पोटी *poti*, 1073.
 पोड़ा *pora*, 1398.
 पौड़ा *poura*, 1005.
 पोहा *porha*, 1006.
 पौहा *pourha*, 1005.
 पोत *pot*, 536, 1220.
 पोता *pota*, 1220.
 पोतेदार *poledār*, 1215.
 पोर *por*, 769, 1010, 1012.
 पोर होरन्ना *por chhorna*, 1010.
 पोरा *pora*, 894, 1183.
 पोला *pola*, 353.
 पोली *poli*, 353.

पोस *pos*, 1235.
 पोसत *posat*, 1028.
 पौडण्डी *paudandi*, 213.
 पौताना *pautāna*, 638.
 पौतिया *pautiya*, 45.
 पौथाना *pauthāna*, 638.
 पौनल्ली *paunalli*, 372.
 पौनिया *pauniya*, 456, 686, 1193.
 पौआ *paua*, 244, 248, 638, 1054,
 1500.
 पौँही *paunchhi*, 1074.
 पौटी *pauti*, 954.
 पौठ *pauth*, 954.
 पौठा *pautha*, 934, 939, 950.
 पौड़ा *paura*, 1247.
 पौँड़ा *paunra*, 308.
 पौँड़ी *paunri*, 646, 1005.
 पौँहा *paunrha*, 309.
 पौँही *paunrhi*, 309.

पौता *pauta*, 656.
 पौतान *pautān*, 363.
 पौती *pauti*, 45, 656.
 पौँती *paunti*, 656.
 पौदर *paudar*, 280, 614, 941.
 पौदर के माँथ *paudar ke mānth*, 941.
 पौधा *paudha*, 949.
 पौना *pauna*, 319, 307, 456, 738,
 686.
 पौनार *paunār*, 365.
 पौनी *pauni*, 1155.
 पौर *paur*, 280, 436, 883, 891,
 959.
 पौरो *pauri*, 262, 280, 436, 891,
 1009.
 पौसार *pausār*, 363 (12).
 पौँसार *paunsār*, 363 (12).
 पौँथ *pauth*, 797.
 प्रीत *prī*, 1209a.

॥ फ ph ॥

फखोरा *phaora*, 27.
 फकाह *phakāh*, 858.
 फकिराना *phakirāna*, 1203.
 फकीर *phakīr*, 669, 1203, 1234.
 फगुआही *phaguāhi*, 1198.
 फगुनी *phaguni*, 1039, 1082.
 फटकन *phatkan*, 1246, 1262.
 फटका *phatka*, 477.
 फटकी *phatki*, 477, 828.
 फटहा *phatha*, 1074, 1105.
 फहा *phattha*, 654, 1074.
 फही *phatthi*, 492, 654.
 फठाह *phathāh*, 1105.
 फठी *phathi*, 224.
 फड़ *phar*, 178, 204, 214.
 फड़का *pharka*, 185.
 फड़की *pharki*, 1416.
 फड़ही *pharhi*, 63.
 फड़था *pharua*, 63.

फण्डा *phanda*, 726.
 फतह *phatah*, 473.
 फतह पेंच *phatah pench*, 473.
 फतिङ्गी *phatingi*, 1074.
 फतील सोज *phatil soj*, 711.
 फतेहा *phatcha*, 463.
 फँदनी *phandni*, 115.
 फँदिया *phandiya*, 375, 828.
 फनकी *phankei*, 376, 115.
 फनगी *phangi*, 1074.
 फनिगा *phaniga*, 1074.
 फन्नी *phanni*, 376.
 फर *phar*, 178, 179, 184, 204, 585,
 1024, 1058.
 फरकभाड़ा *pharakjhāra*, 1105.
 फरकतियावन *pharkatiyāvan*, 1198.
 फरका *pharka*, 646, 1183, 1245.
 फरकाना *pharkāna*, 1198.
 फरकिला *pharkilla*, 179, 164.

- फरकिल्ली *pharkilli*, 164.
 फरकी *pharki*, 29.
 फरखली *pharkhatti*, 1485.
 फरगावल *phārgāwal*, 25.
 फरद *pharad*, 502.
 फरनी *pharni*, 818.
 फरमा *pharma*, 321, 326, 424, 484.
 फरमादस *pharmais*, 1201.
 फरली *pharli*, 1116.
 फरस *pharas*, 750.
 फरसा *pharsa*, 27, 319k.
 फरसी *pharsi*, 473.
 फरहा *pharha*, 335b.
 फरही *pharhi*, 469, 1272.
 फरा *phara*, 1272.
 फराठा *pharātha*, 1272.
 फराठी *pharāthi*, 654.
 फरिकाणा *pharikāna*, 1198.
 फरिङ्गा *pharinga*, 1074.
 फरिया *phariya*, 37, 740.
 फरी *phari*, 29, 179.
 फरहा *pharaha*, 27, 63, 319.
 फरही *pharuhi*, 63, 303, 319, 1272.
 फरेहा *phareha*, 335b.
 फरो *pharo*, 29.
 फरौटा *pharauta*, 335b.
 फल *phal*, 29, 1474.
 फलकर *phalkar*, 1232.
 फलतार *phaltār*, 379.
 फलदान *phaldān*, 1287.
 फलसा *phalsa*, 401.
 फलिया *phaliya*, 740.
 फलुनी *phalguni*, 1039.
 फली *phalli*, 401, 415.
 फंसरगाली *phansargāli*, 115.
 फसलाना *phasilāna*, 1200.
 फहुरा *phahura*, 27, 319k, 369.
 फहुरी *phahuri*, 63, 303, 321.
 फहोडा *phahora*, 27.
 फहोरा *phahora*, 27.
 फाँक *phānk*, 1014.
 फाँकी *phānki*, 1139.
 फायुन *phāyūn*, 1039, 1082, 10
 1084, 1092.
 फाजिल *phājil*, 1186, 1463b.
 फाट *phāt*, 1070, 1214.
 फाटक *phātak*, 1249.
 फाटी *phāti*, 1074.
 फाँड़ *phāñr*, 726.
 फाड़न *phāñan*, 1161.
 फाँड़ा *phāñra*, 726, 1074.
 फाँड़ी *phāñri*, 919, 1074.
 फाँद *phāñd*, 382.
 फाँदा *phāñda*, 382, 648.
 फान *phān*, 646.
 फानी *phāni*, 646, 828.
 फाँफर *phāñphar*, 858.
 फार *phār*, 10.
 फार करा लाएव *phār karā l*
 25.
 फारखली *phārkhatti*, 1485.
 फारन *phāran*, 818.
 फारसी *phārsi*, 585f.
 फारसी गोला *phārsi gola*, 555f.
 फारा *phāra*, 10.
 फारी *phāri*, 29, 1139.
 फालसाही *phālsāhi*, 1043.
 फाला *phāla*, 10.
 फाल्गुन *phālgun*, 1039.
 फाव *phāo*, 900, 1483.
 फाँस *phāns*, 115.
 फाँसत *phānsa*, 18.
 धिक *phik*, 99.
 फिटकिरी *phitkiri*, 425.
 फिरकी *phirki*, 350, 425, 590, 75
 फिरमा *phiranta*, 1474.
 फिरिस *phirist*, 1483.
 फौचब *phīnchab*, 391.
 फुकाठी *phukāthi*, 529, 570.
 फुकाठी *phukhāthi*, 570.

फुची *phuchchi*, 432, 713.
 फुटना *phutna*, 1011.
 फुटपूरी *phutpūri*, 1272.
 फुटहरा *phutahra*, 1272.
 फुटहा *phutha*, 433, 1272.
 फुटिया *phutiya*, 1183.
 फुटहरि *phutehri*, 1272.
 फुदना *phudna*, 99.
 फुदना *phundna*, 100.
 फुदेना *phudena*, 1073.
 फुनगी *phungi*, 1008.
 फुम्मा *phumma*, 100.
 फुफुति *phuphati*, 741.
 फुफुनी *phuphani*, 741.
 फुफुन्दी *phuphundi*, 741.
 फुलको *phulko*, 987.
 फुलकोबी *phulkobi*, 1073.
 फुलगरना *phulgarna*, 507.
 फुलनार *phultār*, 379.
 फुलन्दो *phuldo*, 379.
 फुलडाली *phuldāli*, 45.
 फुलपता *phulpata*, 1028.
 फुलपत्ती *phulpatti*, 1029.
 फुलबघा *phulbagha*, 1176.
 फुलबत *phulbat*, 1176.
 फुलभङ्गा *phulbhanga*, 1074.
 फुलवारी *phulvāri*, 813.
 फुलहर *phulhar*, 1076.
 फुलाब *phulāeb*, 1018.
 फुलिषा *phuliya*, 213.
 फुलुकी *phulukī*, 44.
 फुलना *phulena*, 1183.
 फुलौरी *phulauri*, 1272.
 फुली *phulli*, 1178.
 फूक *phūk*, 414.
 फूकि *phūki*, 1166.
 फूंट *phūnt*, 1065, 1066.
 फूटब *phūtab*, 1018.
 फूटे *phutai*, 1090.
 फूरी *phūri*, 713.

फूल *phūl*, 590, 666, 688, 975, 977,
 978, 1018, 1029, 1043, 1434.
 फूल डाक *phūl dāk*, 1456.
 फूले *phūle*, 1091.
 फूस *phūs*, 1235.
 फूस के वर *phūs ke var*, 1235.
 फूहा *phūha*, 1042.
 फूकलकैक *phenkalkaik*, 1004.
 फूकाइ *phenkai*, 1401.
 फूकैल *phukai*, 646.
 फूटकिना *phuktina*, 125.
 फूटवाल *phetwāl*, 1016, 1019.
 फूटाइन *phetaīn*, 1118.
 फून्चाएल *phenhāel*, 1164.
 फूनुसा *phenusa*, 1164.
 फूफना *phephna*, 1183.
 फूफरियाह *phēphriyāh*, 1098.
 फूरबैक *pherbaik*, 1156.
 फूरवार *pherwār*, 1097.
 फूरहा *pherha*, 942, 1156.
 फूरुषा *pherua*, 140, 756, 769.
 फूरौली *pheraūli*, 1246.
 फूका *phēka*, 646.
 फूटा *phēta*, 259.
 फूंटा *phēnta*, 259, 271, 724.
 फूंटी *phēnti*, 848.
 फूनी *phēni*, 975, 1272.
 फूनुस *phēnus*, 1164.
 फूफरि *phēphri*, 841.
 फूर *pher*, 1087.
 फूरब *pherab*, 1246.
 फूरल *pherāl*, 1267.
 फूरा *phēra*, 831, 889.
 फूरा फारी *phēra phāri*, 291
 फूड़े *phair*, 178.
 फूकना *phokna*, 1272.
 फूकाठी *phokāthi*, 567.
 फूटा *phota*, 1018.
 फूरी *phori*, 748.

फोर *phor*, 801.
फौड़ी *phauri*, 1499.
फौरन *phoran*, 1272.

फोरल *phoral*, 1018.
फौज *phauj*, 1127.
फौरा *phaura*, 27.

॥ व ७ ॥

बग *bae*, 363.
बकन्नल *baknal*, 528, 545.
बकन्नार *baknār*, 528, 545.
बकम *bakam*, 1043.
बकरन्कासाब *bakarkasāb*, 1141.
बकरा *bakra*, 1121.
बकरी *bakri*, 1121.
बकरू *bakru*, 1122, 1123.
बकला *bakla*, 1073.
बकवा *bakwa*, 1263.
बकवा *bakwa*, 1263.
बकसा *baksa*, 372.
बकसिस *baksis*, 1194.
बकुआ *bakua*, 61.
बकुआ *bakucha*, 390.
बकुला *bakula*, 1031, 1074.
बकुली *bakuli*, 1073, 1074.
बकेन *baken*, 1114, 1158.
बकेन के दूध *baken ke dūdh*, 1158.
बकेना *bakena*, 1114.
बकेया *bakeya*, 1074.
बकोइया *bakoiya*, 975.
बकौ *bakan*, 1263.
बकौ *bakan*, 1263.
बकर *bakkar*, 1121.
बकी *bakki*, 1074.
बखन्तौर *bakhtaur*, 1456.
बखरन्दार *bakhardār*, 1214.
बखरा *bakhra*, 125, 1214.
बखरी *bakhri*, 1234.
बखार *bakhār*, 77.
बखारी *bakhāri*, 77, 79.
बखिया *bakhiya*, 748.
बखीर *bakhīr*, 1272.
बखेआ *bakhea*, 748.

बखोर *bakhor*, 1125.
बगन्बहा *bagehhalla*, 1138.
बंग्ठी *bangthi*, 1017.
बगन्डोर *bagdor*, 113.
बंगड़ा *bangra*, 232.
बगमुही *bagmuhī*, 516.
बंगरा *bangra*, 1019.
बंगराह *bangrah*, 799.
बगल *bagal*, 233, 637, 1263.
बगलभरआ *bagalbharua*, 549.
बंगला *bangla*, 1019, 1073,
1254.
बगली तकिया *bagli takiya*, 637.
बगलौटी *bagluti*, 547.
बगसँइसी *bagsaursi*, 516.
बगहा *bagha*, 116, 930.
बगिया *bagiya*, 813, 1272.
बगुरी *baguri*, 111, 768.
बगुली *baguli*, 704, 734.
बगेया *bageya*, 1272.
बगेआ *bagaicha*, 813, 814.
बंगौरिया *bangturiya*, 1080.
बंगौर *bangaur*, 329, 1017.
बंगौरा *bangaura*, 1017.
बंगौरी *bangauri*, 1080.
बघार *baghār*, 1272.
बघेला *baghela*, 363.
बघेली *bagheli*, 469.
बङ्गा *bangā*, 833, 1016.
बचका *bachka*, 1272.
बचवा *bachwa*, 767.
बचाओ *bachāo*, 655.
बचित *bachit*, 1475.
बच्चा *bachcha*, 1116, 1123, 1123.
बचरू *bachhru*, 1118.

- बहवा *bachhwa*, 1118.
 बहिया *bachhiya*, 1118.
 बहेड़ा *bachhera*, 1126.
 बहेड़ी *bachheri*, 1126.
 बजका *bajka*, 1272.
 बजरा *bajra*, 985, 987.
 बजार *bajar*, 959.
 बजर बोंग *bajar bong*, 654.
 बजरी *bajri*, 1000.
 बजा *baja*, 959.
 बजाब *bajāeb*, 1401, 1484.
 बसुला *basulla*, 767.
 बँझौरा *banjhaura*, 1078.
 बँझौरी *banjhauri*, 1078.
 बन्झड़ *banjhar*, 987.
 बन्हा *banjha*, 1398.
 बटकर *batkar*, 1001.
 बटखरा *batkhara*, 643.
 बटनाइ *batnāi*, 594.
 बटनी *batni*, 498.
 बंटनु *bantnu*, 902.
 बटरी *batri*, 44, 442.
 बटलोही *batlohi*, 667.
 बटवन *batvan*, 646.
 बटसारी *batsāri*, 1339.
 बटाइ *batāi*, 913, 902, 903, 914,
 1221, 1468a, 1470.
 बटाइ खरिहानी *batāi kharihāni*, 914.
 बटाम *batām*, 404, 426.
 बटारी *batāri*, 399.
 बटाली *batāli*, 399.
 बटियारी *batiyāri*, 382, 646.
 बटिवन *bativan*, 646.
 बहवा *batua*, 666, 734.
 बहरं *batuṛi*, 734.
 बहरी *baturi*, 772, 1000, 1003.
 बहली *batuli*, 667, 704.
 बटेया *bataiya*, 902.
 बटोरन *batoran*, 899.
 बहा *batta*, 43, 44, 288, 627, 692,
 1202, 1474, 1480; Appendix, 14.
 बहा कम्पनी *batta kampani*, 1203;
 Appendix, 14.
 बहा माल *batta māl*, 1202; Appen-
 dix, 14.
 बहू *battu*, 666, 734.
 बड़ *bar*, 741, 1056, 1217.
 बड़ अदमी *bar admi*, 1217.
 बड़का *barka*, 1263, 1491.
 बड़का राज *barka raj*, 1491.
 बड़की *barki*, 1021, 1276.
 बड़गडमा *bargahuma*, 956.
 बड़गोडमा *bargohuma*, 1075.
 बड़ घोघट *bar ghoghat*, 741.
 बँड़खा *banrehha*, 808, 1016.
 बड़द *barud*, 1096.
 बँड़हड़ा *barhara*, 768.
 बड़हर *barhar*, 768.
 बड़हरा *barhara*, 280, 891.
 बड़हावन *barhāvan*, 893.
 बड़ही *barhi*, 394, 1074, 1194, 1204.
 बड़ही खाना *barhi khāna*, 394.
 बड़होड़ा *barhora*, 891.
 बहार *barār*, 788.
 बड़ि *bari*, 1087.
 बड़ी *bari*, 503.
 बड़ी सूई *bari sūi*, 503.
 बँड़ूखा *banrūkhha*, 1016.
 बड़े *bare*, 478.
 बँड़ूड़ा *banrūra*, 414.
 बँड़ूड़ी *banrūri*, 414.
 बँड़ूर *banrur*, 1257.
 बँड़ूरा *banrera*, 940.
 बँड़ूरी *banrūri*, 1257.
 बड़ैया *baraisa*, 1016.
 बहती *barhti*, 1474.
 बहनी *barhu*, 45, 54, 56, 439, 465.
 बहब *barhab*, 1173.

- बहॉव *barhāw*, 893.
 बही *barhi*, Appendix 2a.
 बहोत्ररी *barhotri*, 1475.
 बण्डा *banda*, 1109.
 बण्डा *bandha*, 1109.
 बतावत *batāwa*, 1026.
 बतास *batās*, 975, 1272.
 बतास फेनी *batās pheni*, 975, 1272.
 बतासा *batāsa*, 585, 975, 1272.
 बतासी *batāsi*, 399.
 बतिसी *batisi*, 558.
 बत्ता *batta*, 224, 179, 1249, 1258.
 बत्ती *batti*, 51, 179, 654, 1258, 1423.
 बथनियारास *bathniyāēl*, 1153.
 बथान *bathān*, 1132, 1147, 1153.
 बथानी *bathāni*, 1147.
 बथुआ *bathua*, 1075.
 बद *bad*, 1125.
 बद कौम *bad kaum*, 1125.
 बद खोम *bad khom*, 1125.
 बदमोहररी *bad mohri*, 1125.
 बदरी *badri*, 1088.
 बदलई *badlāi*, 1461.
 बदला *badla*, 548.
 बदली *badli*, 846.
 बदलया, *badlāya*, 846.
 बदवान *badvān*, 711.
 बदवाँसी *badvānsi*, 808.
 बदमगुन *badshagun*, 1454.
 बदचा *badha*, 735.
 बदहार *badhār*, 828.
 बदामी *badāmi*, 769, 1043.
 बदारौ *badāri*, 77.
 बँदिया *bandiya*, 1098.
 बदीया *badiya*, 417.
 बँदौतनी *bandautni*, 1456.
 बँदौत *bandaut*, 1456.
 बँदौर *bandaur*, 1017.
 बद्धी *baddhi*, 765.
 बधन *badhan*, 432.
 बधना *badhna*, 432, 711, 713.
 बधनी *badhni*, 711.
 बधरना *badharna*, 566.
 बधरा *badhra*, 73.
 बधरिया *badhariya*, 73.
 बधरी *badhri*, 73.
 बधवार *badhwār*, 870.
 बधवारी *badhwāri*, 566.
 बधवाचा *badhwācha*, 870.
 बधार *badhār*, 832.
 बधारू *badhāru*, 73.
 बधिया *badhiya*, 417, 1008, 1112.
 बँधिह *bandhiha*, 829.
 बँधेरी *bandheri*, 121.
 बन *ban*, 158, 178, 268, 478, 513, 813, 815, 842, 844, 852, 874, 1091, 1183, 1185, 1232, 1254, 1408.
 बन उखाव *ban ukhāo*, 1436.
 बन उसरा *ban usra*, 1436.
 बनकर *bankar*, 1232.
 बनगोइठा *bangoiṭha*, 852.
 बन घरा *ban ghara*, 1254.
 बन चिचोली *ban chhioli*, 1232.
 बन चिहली *ban chihuli*, 815.
 बनज्याइन *banjwāin*, 1073.
 बनतुलसी *bantulsi*, 1183.
 बनगौ *banui*, 762.
 बनपियलुआ *banpiyalua*, 1075.
 बनपियाज *banpiyāj*, 1075.
 बन पोस्ता *ban posta*, 1183.
 बनब *banab*, 1343.
 बनभुटका *banbhutka*, 1073.
 बनरसना *banrasna*, 1075.
 बनरा *banra*, 236.
 बनल *banal*, 1086.
 बनवार *banwār*, 1310.
 बन सलवात *ban salwāt*, 1408.
 बनसारी *banasāri*, 1075.
 बनहार *banhār*, 1480.

- बनाव बनाव *banāeb*, 25.
 बनि *bani*, 1185.
 बनिज *banij*, 1461.
 बनिघा *baniya*, 1461.
 बनिघाँ *baniyān*, 914.
 बनिघौटा *baniyauta*, 1188, 1461.
 बनिहार *banihār*, 874, 1184.
 बनिहारा *banihāra*, 842.
 बनिहारी *banihāri*, 869.
 बनी *bani*, 844, 869, 874.
 बनूसार *banusār*, 864, 1436.
 बनौर *banaur*, 1017.
 बनौरी *banauri*, 1080.
 बन्द *band*, 158, 167, 178, 571, 743, 1452.
 बन्द करब *band karab*, 1452.
 बन्दन *bandan*, 1324, 1325.
 बन्दनवार *bandanvār*, 1310.
 बन्दनवार *bandnevār*, 1310.
 बन्दोबस्त *bandobast*, 903, 1221.
 बन्धन *bandhan*, 1331.
 बन्धा *bandha*, 1073.
 बन्धा कोबी *bandha kabi*, 1073.
 बन्धिक *bandhik*, 1480, 1481.
 बन्नी *banni*, 1456.
 बन्सा *bansa*, 24.
 बन्हाका *banhka*, 362.
 बन्हाखरचा *banhkharcha*, 1207.
 बन्हना *banhua*, 119.
 बन्हवैया *banhwaiga*, 1201.
 बन्हाप्रब *banhāeb*, 1426.
 बपन्स *bapans*, 1214.
 बपन्हर *baphar*, 1299.
 बपन्हन्स *baphans*, 1214.
 बपौटी *bapanti*, 1214.
 बफौरी *baphauri*, 1272.
 बबरन्ची *babarchi*, 1248.
 बबरन्ची खाना *babarchi khāna*, 1218.
 बबई *babui*, 1295.
 बबुटोला *babutola*, 1217.
 बभन *babhan*, 1285, 1343.
 बभन पुच्छी *babhan puchhki*, 1285, 1343.
 बभन्नी *blabhani*, 787, 1074.
 बभन्नौ *babhnau*, 725.
 बभुटा *babhuta*, 767.
 बस *ban*, 922.
 बसगोला *bangola*, 585.
 बसैला *banaila*, 362.
 बम्बू *banbu*, 1034.
 बघा *bagya*, 914.
 बगार *bagār*, 1201.
 बघाना *bagāna*, 1483.
 बार *bar*, 1005, 1274, 1281, 1287.
 बारई *barāi*, 45, 1049.
 बार ऊख *bar ūkh*, 1005.
 बारक *barak*, 1333.
 बारकत *barakat*, 1483.
 बारक बेसाप्रब उठाप्रब *barak baisāeb* *uthāeb*, 1333.
 बारकब *barakas*, 243.
 बारका *barka*, 1175.
 बारकाबर *barkābar*, 727.
 बारका बेसारी *barka bemāri*, 1175.
 बारकी *barki*, 740.
 बारखा *barakha*, 965, 1083, 1087, 1088, 1091.
 बारखी *barakhi*, 1185, 1427.
 बारखू *barakha*, 1117.
 बारग *baray*, 1313.
 बारगा *barga*, 1258.
 बारगुना *barguna*, 672.
 बारग्वरा *barghara*, 1153.
 बारखा *barachhha*, 1287.
 बारहा *barchhā*, 102.
 बारही *barchhi*, 102.
 बार चँका *bar chhenka*, 1287.
 बारजौर *barjaur*, 1272.
 बारत *bart*, 1442.

- बरत *barat*, 491.
 बरन्ता *barata*, 121, 276.
 बरन्ती *barti*, 121.
 बरन्तुहार *bartuhār*, 1286.
 बरन्तुहारी *bartuhāri*, 1286.
 बरन्तूर *bartūi*, 1285.
 बरन्तूही *bartūhi*, 1286.
 बरन्तूही के भात *bartūhi ke bhāt*, 1286.
 बरद *barad*, 657, 841, 1087, 1096.
 बरन्दरी *bardari*, 248, 1236.
 बरन्दबनिया *baradbaniya*, 1456.
 बरदन्वान *baradwān*, 702.
 बरदा *barda*, 1118.
 बरदाप्रब *bardāēb*, 1115.
 बरदाप्रख *bardāēl*, 1116.
 बरदाना *bardāna*, 1151, 1201.
 बरदिया *baridiya*, 1151.
 बरदेखी *bardekhi*, 1285.
 बरध *baradh*, 1096, 1097.
 बरधा *bardha*, 1088, 1094.
 बरधियाप्रब *bardhiyaēb*, 1115.
 बरन *baran*, 12, 784.
 बरनी *barni*, 489.
 बरफी *barphi*, 1272.
 बरन्म पिचास *barṃ pichās*, 1458.
 बरन्मा *barṃa*, 398, 415, 470, 471, 540, 583.
 बरन्माँ *harmān*, 398.
 बरन्मोतर *barṃotar*, 1209a.
 बररिया *barariya*, 378.
 बररी *barri*, 1043.
 बररे *barre*, 1043.
 बरल *baral*, 123.
 बरल रस्सी *baral rassi*, 123.
 बरवाह *barwāh*, 915, 945.
 बरवे *barve*, 1050.
 बरन्साइन *barsāin*, 1114, 1398.
 बरन्से *barse*, 966, 1084, 1085, 1087, 1090, 1092.
 बरन्से *barsai*, 1088.
 बरन्सेनो *barsaino*, 1398.
 बरह *barah*, 116, 276, 930.
 बरहत्ता *barhattha*, 751.
 बरहत्थी *barhatthi*, 740.
 बरहन्दरी *barahdari*, 248, 1236.
 बरहन् *barhan*, 12.
 बरहम *barham*, 1455, 1456.
 बरहम अस्थान *barham asthān*, 145
 बरहम देव *barham deo*, 1456.
 बरहन्मन *barahman*, 1217.
 बरहा *barha*, 33, 115, 116, 12 930.
 बरही *barhi*, 33, 118, 121, 1406.
 बरहै *barhai*, 1090.
 बरहौघर *barhaughar*, 1234.
 बरा *bara*, 1272, 1491.
 बराइन *barāin*, 12.
 बराप्रब *barāēb*, 949.
 बरा गज *bara gaj*, 1491.
 बराँटी *brānti*, 975.
 बराठी *barāthi*, 1250.
 बरात *barāt*, 1290.
 बरार *barār*, 788.
 बराहिल *barāhil*, 871.
 बरियात *bariyāt*, 1043, 1290, 13 1379.
 बरियार *bariyār*, 800, 808, 922.
 बरियार पानी *bariyār pāni*, 922.
 बरिसे *barise*, 1089.
 बरी *bari*, 994, 1272, 1369, 138
 बरुवा *barua*, 239, 639, 859.
 बरुका *baruka*, 713.
 बरेन *baren*, 12.
 बरेषी *barekht*, 767, 1285.
 बरेठा *baretha*, 414.
 बरेव *bareo*, 1050.
 बरेठा *baraiṭha*, 1050.
 बरैन *barain*, 12.
 बरैनी *baraini*, 12.
 बरैणी *baraunkhi*, 1005.

- बरौंजी *baraunchhi*, 536.
 बलकट *balkat*, 875, 1198, 1223.
 बलकसी *balkasi*, 785.
 बलको *balko*, 984.
 बलखा *balkhā*, 388.
 बलखोरया *balkhoiya*, 984.
 बलनार *baltār*, 379.
 बलथर *balthar*, 785.
 बलधूस *baldhūs*, 785.
 बलमन्टार *balamtār*, 767.
 बलरक्खा *bal rakkha*, 870, 871.
 बलरखी *balrakhī*, 870.
 बलरी *balri*, 984.
 बलवा *balwa*, 785.
 बलवाह *balwāh*, 785.
 बलसार *balsār*, 1008.
 बलसुंदरी *balsundri*, 785.
 बलसुन *balsun*, 785.
 बलसुन्दर *balsundar*, 785, 787.
 बलसुम *balsum*, 785.
 बलसुम्ही *balsumhī*, 785.
 बलाइ *balāi*, 1165.
 बलान *balān*, 788.
 बलिदान *balidān*, 1457.
 बलिस्ता *balista*, 637.
 बलिहा *balīha*, 379.
 बलुथ *baluath*, 377, 785.
 बलुआ *balua*, 785, 802, 1074.
 बलुआ बाँगर *balua bāngar*, 802.
 बलुआ भीठ *balua bhīth*, 802.
 बलुई *balui*, 1074.
 बलुखा *balukha*, 1004.
 बलुरी *baluri*, 984.
 बलुसाही *balusāhī*, 1272.
 बलुआ *balea*, 757.
 बलेठा *balētha*, 377.
 बलम *ballam*, 102.
 बला *balla*, 183, 185, 200, 322, 940, 1258.
 बली *balli*, 217, 1258.
 बँवरिया *bamwariya*, 363.
 बँवारी *bamwāri*, 363.
 बस *bas*, 1025.
 बसगित *basgit*, 796.
 बँसजोती *bansjoti*, 33.
 बँसजोर *bansjor*, 931.
 बसन्ती *basī*, 784.
 बसन्दौरी *basdauri*, 1407.
 बसन्नी *basni*, 693, 713.
 बँसफँटा *bansphenta*, 354.
 बसन्ती *basanti*, 572.
 बँसफट्टा *bansphattha*, 654.
 बँसवल्ली *bansballi*, 183.
 बसमतिया *basmatiya*, 976, 979.
 बसन्वया *baswanta*, 1183.
 बँसवार *banswār*, 814.
 बँसवारी *banswāri*, 814.
 बँसहा *basaha*, 1111.
 बसाइ *basār*, 814.
 बसाँदी *basārhi*, 1075.
 बसावन कुँवर *basāvan kuñar*, 1456.
 बसिया *basīya*, 1272.
 बसिला *basila*, 395.
 बसुही *basurhi*, 1201.
 बसुला *basula*, 394, 395, 470.
 बसुली *basuli*, 421.
 बसुला *basūla*, 395.
 बसे *base*, 393.
 बसेइ *baser*, 814.
 बसौंता *basāunta*, 1075, 1183.
 बँसौरा *bansaura*, 183.
 बस्त *bast*, 1218.
 बस्तार *bastar*, 723, 965.
 बह *bah*, 954, 1275.
 बहकल *bahkal*, 1132.
 बहका *bahka*, 533.
 बहखा *bahkha*, 32.
 बहंगी *bahangi*, 651, 657.
 बहगुना *bahguna*, 674.
 बहट *bahat*, 1132.

बहट जाप्रव *bahat jāēb*, 1132.
 बहना *bahna*, 713, 954.
 बहब *bahab*, 817.
 बहर *bahar*, 1254.
 बहरघरा *baharghara*, 1153, 1254.
 बहरनी *baharni*, 972.
 बहरन्म *baharbhām*, 784b, 790.
 बहरन्सी *baharsi*, 784b, 1147.
 बहरिया *bahariya*, 1203, 1458.
 बहरीया *bahraiya*, 1203.
 बहरो *bahro*, 1162.
 बहल *bahal*, 148, 207.
 बहली *bahli*, 148, 207.
 बहलोली *bahloli*, 769.
 बहसलि *bahsali*, 356.
 बहारन *bahāran*, 848.
 बहारल *bahāral*, 58.
 बहावे *bahāve*, 1088.
 बहिगा *bahinga*, 651, 657.
 बहिघा *bahiya*, 1184.
 बहियार *bahiyār*, 3, 784, 832, 1147.
 बहिरा *bahera*, 379.
 बहिला *bahila*, 1114, 1398.
 बही *bāhi*, 280, 941, 1462, 1463b
 and c, 1485.
 बही खाता *bahi khāta*, 1462.
 बही पर से नाम उतर गेल *bahi par se
 nām utar gel*, 1485.
 बह्वासिन *bahvāsīn*, 1293.
 बहृता *bahutta*, 767.
 बहृता *bahunta*, 767.
 बहत *bahut*, 240, 829, 841, 1002.
 बहुरा *bahura*, 1294, 1443.
 बहुरी *bahuri*, 1272.
 बहू *bahu*, 1275.
 बहेलिया *baheliya*, 381.
 बहे *bahe*, 1087, 1088.
 बहेली *baheli*, 148, 207.
 बहे *bahai*, 1087, 1088.
 बहोरनी *bahorni*, 972.

बहोड़ *bahor*, 1456.
 बहोर *bahor*, 1294.
 बा *ba*, 741, 957, 987, 1001, 1089.
 बाउग *bāüg*, 855.
 बाओग *bāög*, 855, 964.
 बाँक *bānk*, 233, 325, 416, 583, 75
 767, 977.
 बाँकटा *bānkta*, 1077.
 बाँक रुखानी *bānk rukhāni*, 400.
 बाकल *bākal*, 233.
 बाकस *bākas*, 656.
 बाँका *bānka*, 1074.
 बाकी *bāki*, 1463b, 1468a, 1472.
 बाँकी *bānki*, 583, 1074.
 बाकी तहन्बील *bāki tahbīl*, 1463b.
 बाग *bāg*, 813, 978, 1124.
 बाँग *bāng*, 1019, 1020.
 बाग डोर *bāg dor*, 113.
 बाग नर *bāgnar*, 978.
 बाँग सलन्वात *bāng salcāt*, 1408.
 बाँगर *bāngar*, 204, 786, 802.
 बाँगर करैल *bāngar karail*, 786.
 बाँगा *bānga*, 329, 1016, 1017, 101
 1019.
 बाँगा फूटब *bānga phūtab*, 1018.
 बाँगो *bāngo*, 1016, 1017, 1018, 1019
 बाँगो फूटब *bāngo phūtab*, 1018.
 बाक्षा *bāchha*, 1118.
 बाक्षी *bāchhi*, 1118.
 बाज *bāj*, 585.
 बाजन *bājan*, 1026.
 बाजू *bāju*, 767.
 बाँझ *bāñh*, 1398.
 बाँझ बहिला *bāñh bahila*, 1398.
 बाँझिन *bāñhin*, 1398.
 बाँझी *bāñhi*, 1078.
 बाट *bāt*, 643.
 बाँट *bānt*, 902, 1214.
 बाँटल *bāntal*, 123.
 बाँटल रस्सी *bāntal rassi*, 123.

बाढी *bāṭi*, 677, 692, 1084.
 बाँढी *bāṅṭi*, 902.
 बाढोतन्वरग *bātotsarg*, 1459.
 बाँङ्क *bāṅk*, 789, 987, 1109.
 बाङ्गा *bāṅga*, 1272.
 बाँङ्गा *bāṅga*, 1109.
 बाङ्गी *bāṅgi*, 784, 1040.
 बाङ्गी *bāṅgi*, 1275.
 बाढ़ *bārh*, 588, 1080.
 बाढ़न *bārhan*, 54.
 बाढ़नि *bārhani*, 54.
 बाढ़ब *bārhab*, 58.
 बाढ़ि *bārhi*, 1080.
 बात *bāt*, 478, 1088, 1181.
 बात *bāta*, 233, 1174, 1249, 1258.
 बाती *bāṭi*, 51, 1258, 1423.
 बादर *bādar*, 1088.
 बादिवा *bādiya*, 417.
 बाध *bādhi*, 639, 784, 1147.
 बाँध *bāndh*, 77, 833, 919, 953.
 बाँधब *bāndhab*, 1378.
 बाध *bādha*, 642, 735.
 बाधी *bādhi*, 184.
 बान *bān*, 167, 478, 585, 639, 864,
 982, 1113.
 बागर *bāgar*, 834.
 बाना *bāna*, 1042, 1195.
 बानी *bāni*, 849, 1195.
 बान्ह *bānh*, 741, 919, 953.
 बान्हल *bānhal*, 444.
 बाप *bāp*, 393, 1043.
 बापक *bāpak*, 356, 781.
 बाँबू *bāmbū*, 1034.
 बाभन *bābhan*, 964, 1451.
 बामन *bāman*, 999 (note).
 बाया *bāya*, 914.
 बारन्ता *bārta*, 375.
 बारह *bārah*, 1020.
 बारन्हो *barho*, 1086.
 बारा *bāra*, 562, 1205, 1272.

बारी *bāri*, 753, 807, 832, 1016,
 1148, 1218.
 बारी बल *bāri bast*, 1218.
 बाल *bāl*, 788, 958, 984, 986, 990,
 1189, 1411.
 बाल हड़ *bāl chhar*, 1381.
 बाल तराशी *bāl tarāshi*, 1411.
 बालम *bālam*, 1070.
 बालम खीर *bālam khīrā*, 1070.
 बाला *bāla*, 757, 768, 785, 936,
 1074, 1258.
 बालिस *bālis*, 1266.
 बाली *bāli*, 753, 764, 958.
 बालीस *bālis*, 637.
 बालू *bālu*, 324, 1074.
 बालूचर *bālūchar*, 1037.
 बालू मेज *bālu mej*, 324.
 बालू साही *bālu sāhi*, 1272.
 बालै *bālai*, 1376.
 बालै मीयाँ *bālai miyān*, 1376.
 बावग *bāvag*, 818, 855, 857, 863,
 964, 1008, 1039.
 बावग करब *bāvag karab*, 855.
 बान्वली *bāwli*, 215, 224, 704, 920.
 बास *bās*, 356.
 बाँस *bāns*, 183, 242, 249, 814, 931,
 978, 1491.
 बाँसक *bānsak*, 814.
 बाँसक बीठ *bānsak bīth*, 814.
 बाँस के कोठी *bāns ke kothī*, 814.
 बासघर *bāsgar*, 1320.
 बाँस फूल *bāns phūl*, 978.
 बासमती *bāsmatī*, 973, 975, 977,
 978, 979.
 बासा *bāsa*, 978, 1236.
 बाँसा *bānsa*, 24.
 बासा पसिन *bāsa pasin*, 978.
 बासी *bāsi*, 1272.
 बाँसी *bānsi*, 1075.
 बासी कुसी *bāsi kūsī*, 1272.

- बाँह *bānh*, 533, 568, 817.
 बाहब *bāhab*, 1115.
 बाहा *bāha*, 954.
 बाँही *bānhi*, 558.
 बाँहू *bānhu*, 768.
 बिचहन *biahan*, 1121, 1189.
 बिकरी *bikri*, 1346, 1468a, 1470,
 1472, 1479; Appendix, 14.
 बिकरी आम *bikri am*, Appendix, 14.
 बिकरी के भाव *bikri ke bhāo*, 1479.
 बिकौषा *bikaua*, 1346.
 बिकिया *bikhiya*, 1281.
 बिकेया *bikheya*, 1281.
 बिगनरल *bigral*, 1077.
 बिगनरल हसिल *bigral hāsīl*, 1077.
 बिगनरटी *bighatī*, 1194.
 बिगन्हा *bigha*, 1020, 1495, 1496.
 बिचनरा *bichra*, 862.
 बिहार *bihār*, 1088.
 बिच्चा *bichcha*, 856, 878.
 बिच्ची *bichchi*, 533, 1024.
 बिखरनी *bichharni*, 392.
 बिखरब, *bichharab*, 391.
 बिखन्वतिया *bichhvatīya*, 1075.
 बिखाचोन *bichhāon*, 637.
 बिखिया *bichhiya*, 772.
 बिहुषा *bichhua*, 196.
 बिहुटी *bichhuti*, 726.
 बिहौतिया *bichhautiya*, 1075.
 बिहौना *bichhauna*, 637.
 बिजन्वण्ट *bijghant*, 776.
 बिजन्मार *bijmār*, 859, 1078.
 बिजन्लौ *bijli*, 764.
 बिजाग्रठ *bijāeth*, 767.
 बिजावठ *bijāvath*, 754, 767.
 बिजुली *bijuli*, 767.
 बिजौठा *bijautha*, 754, 767.
 बिठम *bitan*, 233.
 बिठ्ठा *bittha*, 652.
 बिठरै *bitharai*, 209.
 बिँदा *binra*, 894.
 बिँरुन्ही *birnri*, 652.
 बिँरार *birār*, 798, 818, 862, 982.
 बिँरिया *binriya*, 149, 196, 652, 1090.
 बिँरुषा *birrua*, 652.
 बिण्डा *binda*, 937.
 बिण्डी *bindi*, 924.
 बिना *bitta*, 1489, 1490.
 बिथार *bithār*, 713.
 बिदहन्नी *bidahni*, 824, 826.
 बिदागन्नी *bidāgni*, 1294.
 बिदागी *bidāgi*, 1291, 1294.
 बिदाह *bidāb*, 824, 826.
 बिदिन *bidit*, 1090.
 बिदेसी बरन्म *bidēsi barm*, 1456.
 बिधन्करी *bidhkarī*, 1355.
 बिधन्वा *bidhwa*, 1088, 1279.
 बिन *bin*, 1025, 1085, 1088.
 बिनगनिहार *binnihār*, 878.
 बिनग्हाइ *binhāi*, 856.
 बिनग्हामो *binhāmo*, 1095.
 बिना *bina*, 1090.
 बिनाइ *bināi*, 639.
 बिनाव *bināw*, 639.
 बिनावठ *bināwat*, 248, 639.
 बिनियॉ *binīyān*, 877.
 बिनुषा *binua*, 852.
 बिनुषा गोइठा *binua goitha*, 852.
 बिनौट *binaut*, 639.
 बिन्दी *bindi*, 747.
 बिन्वा *bindha*, 1176.
 बिबाह *bibāh*, 1273.
 बिघडनी *biyahuti*, 241.
 बिघडती पालन्की *biyahuti pālki*, 241.
 बियाज *biyāj*, 1475.
 बियाजू *biyāju*, 1485.
 बियान *biyān*, 1116.
 बियाना *biyāna*, 1116.
 बियामार *biyāmār*, 859.
 बियार *biyār*, 862, 982.

- बियाह *biyāh*, 1194, 1273.
 बियाह दानी *biyāh dāni*, 1194, 1201, 1273.
 बियाही *biyāhi*, 1276, 1338.
 बियाही भात *biyāhi bhāt*, 1338.
 बियाही *biyāhi*, 1196.
 बिरन्ही *bir̥khi*, 767.
 बिरन्घोतसरग *bir̥khotsarg*, 1459.
 बिरन्घियाप्रल *bir̥niyāpral*, 1076.
 बिरन्घा *bir̥ca*, 1056.
 बिरन्घा *bir̥wāi*, 1073.
 बिरन्घरा *bir̥ahra*, 660, 1055.
 बिरन्घा *bir̥ha*, 1154.
 बिराह *birāh*, 826.
 बिरित *bir̥it*, 1194, 1209, 1209d.
 बिरितन्धार *bir̥itdār*, 1209.
 बिरितिहा *bir̥itihā*, 1209.
 बिरिया *bir̥iya*, 196, 335f, 1055.
 बिरेंटी *bir̥enti*, 767.
 बिलस्त *bilast*, 1489.
 बिलस्ता *bilasta*, 637, 1489.
 बिलन्घस्त *bil̥hast*, 1489.
 बिलाप्रती *bilāṭi*, 328, 1021, 1059, 1073.
 बिलाप्रती पद्म्या *bilāṭi padmā*, 1073.
 बिलाप्रती बैंगन *bilāṭi baingān*, 1073.
 बिलैया *bilāiya*, 175, 183, 1250.
 बिल्ली *billi*, 1250.
 बिशुन *bishun*, 1209a.
 बिशुन अरण्यन *bishun ar̥ṇyan*, 1209a.
 बिशुन प्रीत *bishun pr̥it*, 1209a.
 बिसन्हाब *bish̥hāb*, 1158.
 बिसन्टी *bisti*, 726.
 बिसन्मादी *bismādi*, 867.
 बिसन्मिल *bismil*, 1499.
 बिसन्राँव *bisrāṅw*, 1416.
 बिसन्री *bisri*, 646.
 बिसन्घा *biswā*, 1496.
 बिसन्घरा *bisahra*, 1456.
 बिसाखा *bisākha*, 1082.
 बिसाही *bisārhi*, 1183.
 बिसार *bisār*, 646.
 बिसारी *bisāri*, 646.
 बिसुखब *bisukhab*, 1158.
 बिसुन *bisun*, 914, 971, 1203.
 बिसुन अन्त *bisun an*, 1203.
 बिसुनटिया *bisunatiyā*, 971.
 बिसुन पिरित *bisun p̥it*, 914, 971, 1203.
 बिस्वकर्मा *bisvakarmā*, 299.
 बिहड़ *bihar*, 791.
 बिहन्गोद्या *bihandhōyā*, 864.
 बिहन्गार *bihnāi*, 856, 859, 862, 982.
 बिहन्तार *bihantār*, 862.
 बिहँसि *bihānsi*, 1088.
 बिहा *bihā*, 1273.
 बिहान *bihān*, 362.
 बिही *bihī*, 1276.
 बिहौती *bihauti*, 1322.
 बीच *bich*, 833, 1451.
 बीतक *bijak*, 1483.
 बीभल *bijhal*, 1074.
 बीट *bit*, 233.
 बीटो *bito*, 814.
 बीठ *bith*, 814.
 बीठा *bithā*, 652.
 बीठो *bittho*, 652.
 बीड़ *bīr*, 764.
 बीड़ *bīr*, 149, 924, 1096.
 बीड़ा *bīrā*, 1055.
 बीड़ो *bīrō*, 652.
 बीन *bin*, 585, 1073.
 बीनन *bīnan*, 639.
 बीबी *bibi*, 1377.
 बीबी के सहन्क *bibi ke sah̥nk*, 1377.
 बीम *bim*, 322.
 बीमा *bimā*, 1483.
 बीघड़ *biyār*, 1121.
 बीघा *biyā*, 856, 862, 982, 1057, 1070, 1078, 1189.

- बीया के बालू *biya ke ālu*, 1057.
 बीया बाल *biya bāl*, 1189.
 बीया बेंगा *biya bengā*, 1189.
 बीया मार *biya mār*, 1078.
 बीर *bir*, 409, 965a, 1456.
 बीरी *bīri*, 335f, 409, 1272.
 बीँवा *biñva*, 1483.
 बीहड़ *bīhār*, 791.
 बीहन *bīhan*, 856, 862, 982, 1008, 1189.
 बुदयाम *buiyām*, 372.
 बुकुचा *bukua*, 1320.
 बुकुचा उद्दार *bukua urāi*, 1320.
 बुक्की *bukki*, 737.
 बुध्मारथ *bujhārath*, 1485.
 बुभौता *bujhauta*, 1485.
 बुद्धा *butta*, 959.
 बुद्धबक *burbak*, 741.
 बुद्धवा *burhva*, 969.
 बुद्धिया *burhiya*, 1074.
 बुद्धुदाय *budhudāy*, 1084.
 बुनियॉ *buniyān*, 1272.
 बुरन्जी *burji*, 585.
 बुरिबक *buribak*, 394.
 बुरज *buruj*, 399, 402.
 बुरज खाप *buruj khāp*, 402.
 बुरज खाब *buruj khāb*, 402.
 बुलाक *bulāk*, 763.
 बुई *būi*, 1458.
 बुज्जब *būjhab*, 1484.
 बूँट *būnt*, 994, 1002.
 बूँटी *būti*, 475.
 बूँटी *būnti*, 1003.
 बूँल *būral*, 1477.
 बूँल भेलै *būral bhelai*, 1477.
 बूड़ा *būra*, 1458.
 बूत *būt*, 724.
 बूत के पगन्डी *būt ke pagri*, 724.
 बूनब *būnab*, 855.
 बूनल *būnal*, 855.
 बेबाज *beāj*, 1475.
 बेबाजू *beāju*, 1485.
 बेबाना *beāna*, 1483.
 बेबालू *beālu*, 1270.
 बेबेंगा *beūnga*, 486.
 बेबोपार *beopār*, 1461.
 बेबोंगा *beonga*, 486.
 बेबोंगी *beongi*, 486.
 बेबोतब *beotab*, 1371.
 बेकत *bekat*, 1275.
 बेगन्वा *bengwa*, 785.
 बेगार *begār*, 844, 1184.
 बेगारी *begāri*, 1184.
 बेभन्ना *bejhna*, 959.
 बेटन्वा *betwa*, 1281.
 बेटिया *betiya*, 1282.
 बेँडूठी *beñrāthi*, 1250.
 बेँडिया *beñriya*, 414.
 बेहियॉ *berhiyān*, 1183.
 बेतन्डी *betri*, 121.
 बेदामी *bedāmi*, 1043.
 बेधन्वार *bedhwār*, 566.
 बेनाठी *benāthi*, 1250.
 बेनिया *beniya*, 747, 1272.
 बेनियॉ *beniyān*, 529, 1249.
 बेबाक *bebāk*, 1485.
 बेबाक भैल *bebāk bhail*, 1485.
 बेमारी *bemāri*, 1175.
 बेयाइ *beyāi*, 914.
 बेयापार *beyāpār*, 1461.
 बेरई *berāi*, 959.
 बेरन्ना *berra*, 959.
 बेरहन्टिया *berhatiya*, 1270.
 बेरहिन *berhin*, 1272.
 बेरन्ही *berhi*, 1272.
 बेरन्हीया *berhāya*, 1272.
 बेराठी *berāthi*, 1250.
 बेरुआ *berua*, 96, 239.
 बेलन्ना *belna*, 346, 457, 628.
 बेलन्नी *belni*, 611.

- बेखानन *belwan*, 1183.
 बेलहरा *belahra*, 660, 768, 1055.
 बेलहरी *belahri*, 660, 1049.
 बेलहरी साँची *belahri sānchi*, 1049.
 बेलोन्हा *belonha*, 1183.
 बेलौधन *belauṅghan*, 1183.
 बेलौघा *belauṅgha*, 1183.
 बेलौर *belaur*, 965h.
 बेवरा *beṅwara*, 1250.
 बेवहरगत *bevhargat*, 1461.
 बेवहरिया *bevhariya*, 1481.
 बेवहार *bevhār*, 1461.
 बेसना *besna*, 78.
 बेसहिहठ *besahika*, 1113.
 बेरहा पाँचे *behra pañche*, 1415.
 बेसाखी *besākhi*, 654.
 बेसाहै *besāhai*, 1113.
 बेहरा पाँचे *behra pañche*, 1415.
 बेहरी *behri*, 1303.
 बेहवरिया *behwariya*, 1461.
 बेहवाल *behwāl*, 1094.
 बे *be*, 796.
 बे *ben*, 490.
 बेगा *benga*, 486, 785, 862, 982, 1173, 1189.
 बेच *bencha*, 1088.
 बेचो *bencho*, 1087.
 बे चप्पर *be chhappar*, 796.
 बेट *bent*, 29, 60, 75, 87, 88.
 बेटा *beta*, 1451.
 बेटा का सिर पर हाँथ धै क *beta ka sir par hānth dhai kan*, 1451.
 बेथन *bethan*, 389.
 बेरु *benr*, 1250.
 बेरा *benra*, 1250.
 बेरी *beri*, 1130.
 बह *berh*, 1148.
 बेही *berhi*, 77.
 बेती *benti*, 121.
 बेद *bed*, 1090.
 बेदाम *bedām*, 1002.
 बेदि *bedi*, 1332.
 बेदि घुमाग्र *bedi ghumāc*, 1332.
 बेना *bona*, 1249.
 बेनी *beni*, 747, 1249.
 बेर *ber*, 1234.
 बेरा *bera*, 757, 768, 1234.
 बेरी *beri*, 1183.
 बेरो *bero*, 814.
 बेल *bel*, 198, 749, 1052.
 बेलन *belan*, 498, 595, 628.
 बेलि *beli*, 154.
 बेली *beli*, 154.
 बेव *beṅw*, 490.
 बेवा *bewa*, 1279.
 बेसन *besan*, 1272.
 बेसर *besar*, 763.
 बेगनी *baingni*, 1043.
 बैठका *baithka*, 1239.
 बैठकी *baithki*, 442, 1320.
 बैठनी *baithni*, 623.
 बैठाचोल *baithāc*, 795.
 बैठार *baithār*, 1153.
 बैतरनी *baitarṅni*, 973.
 बैरिया *bairiya*, 1113, 1135.
 बैरिया गोल *bairiya gol*, 1113, 1135.
 बैसका *baiska*, 623.
 बैसको *baisko*, 623.
 बैसकखा *baisakkha*, 1084.
 बैसनी *baisni*, 623.
 बैसाग्र *baisāc*, 1328, 1333, 1429.
 बैसाख *baisākh*, 1039, 1052.
 बैसाचोल *baisāc*, 851.
 बै *bai*, 363.
 बैंग *baingan*, 1073.
 बैठ *baith*, 1113.
 बैठल *baithal*, 1076.
 बैठल हासिल *baithal hāsīl*, 1076.
 बैठे *baithe*, 568.
 बैदार *baidār*, 1214.

बैदिक *baidik*, 1459.
 बैधव *baidhab*, 1279.
 बैना *baina*, 1113.
 बै बिल वफा *bai bil wapha*, 1482
 बैर *hair*, 1430.
 बैरागी *bairāgi*, 733.
 बैरी *bairi*, 1073.
 बैलट *bailat*, 491.
 बैलठ *bailath*, 491.
 बैल *bail*, 128, 261, 572, 841, 889,
 999n, 1096, 1097, 1113, 1118.
 बैस *bais*, 416, 1343:
 बैसक *baisak*, 78.
 बैसन *baisan*, 623.
 बैसव *baisab*, 1429.
 बैसे *baise*, 1089.
 बैहार *baihār*, 784.
 बोकड़ा *bokra*, 963, 1121.
 बोकला *bokla*, 984, 1031, 1073.
 बोकला बीन *bokla bin*, 1073.
 बोगदा *bogda*, 1141.
 बोगदा *bogha*, 863, 964, 968. "
 बोगिया *bogiya*, 49.
 बोगेड़ा *bogera*, 964.
 बोभनिया *bojhaniya*, 321.
 बोभनिया चौद *bojhaniya haud*, 321.
 बोभनवाटार *bojhatāi*, 913.
 बोभार *bojhāi*, 321, 372.
 बोभार के चौद *bojhāi ke haud*, 321.
 बोहनी *bohni*, 53, 439.
 बोन *bon*, 844.
 बोनी *boni*, 1185.
 बोरसी *borsi*, 1247, 529.
 बोहनी *bohni*, 1480.
 बोहनी बहा *bohni batta*, 1480.
 बोहारव *boharab*, 58.
 बोहनी *boñni*, 855, 863.

बोबल *boül*, 855.
 बोबार *boäi*, 855.
 बोहन *boin*, 1017.
 बोहल *boiha*, 1084.
 बोए *boe*, 967, 1085, 1086.
 बोका *boka*, 1121.
 बोंग *bong*, 654.
 बोभा *bojha*, 882, 884, 885, 886
 913, 1013, 1145, 1194, 1196.
 बोहन *borhan*, 53.
 बोता *bota*, 472, 1131.
 बोनू *botu*, 1121.
 बोनो *boto*, 1121.
 बोदर *botar*, 951.
 बोनी *boni*, 855.
 बोर *bor*, 1272.
 बोर बोर *bor bor*, 1272.
 बोरस *boras*, 1247.
 बोरा *hora*, 130, 982.
 बोरो *boro*, 980.
 बोली *boli*, 1091.
 बोले *hole*, 1088.
 बोहा *boha*, 1050.
 बाँडण्डी *bandandi*, 213.
 बाँषा *baui*, 1088.
 बाँखा *baunkha*, 32, 768.
 बाँड़ी *bañri*, 1499.
 बाँघा *baugha*, 858.
 बाँफेर *baupher*, 1458.
 बाँरा *baura*, 1294.
 बाँली *bauli*, 224.
 बाँह *bauih*, 1275.
 ब्रम्भोज *brambhoj*, 1426.
 ब्राह्मन *brāhman*, 1286, 1426.
 ब्राह्मन के गोड़ू कू *brāhman ke gō
 chhu kū*, 1451.
 ब्राह्मन जेवनार *brahman jconār*, 1426

॥ भ bh ॥

भरचारा *bhaiara*, 1345.
 भरचारी *bhāiāri*, 1345.

भरचारे *bhāiāre*, 1345.
 भरचारो *bhaichāro*, 1345.

- भईं *bhaīn*, 1120.
 भए *bhae*, 1026, 1085.
 भख चट्या *bhakh chatua*, 1076.
 भखड़ *bhakhhar*, 1078.
 भखड़ जाएब *bhakhhar jāēb*, 1078.
 भखियाएल *bhakhijāēl*, 1076.
 भगई *bhagai*, 726.
 भगत *bhagal*, 1453.
 भगन्ताइ *bhagtaī*, 1453.
 भगनिया *bhagatiya*, 1453.
 भंगरा *bhangra*, 1075.
 भंगरिया *bhangariya*, 1075.
 भंगरैया *bhangraīya*, 1075.
 भगवा *bhagva*, 726.
 भगाड़ *bhagār*, 920c.
 भगेलिया *bhageliya*, 1486.
 भङ्ग *bhankh*, 1074.
 भङ्ग *bhang*, 1036.
 भंजनी *bhanjñi*, 363.
 भंजहरिया *bhanjharīya*, 291, 846.
 भंजहा *bhanjha*, 1172.
 भंजावाला *bhānjā wāla*, 846.
 भंजैठ *bhanjeth*, 846.
 भंजैत *bhanjait*, 846.
 भंजौती *bhanjauti*, 846.
 भञ्जा *bhanja*, 846.
 भटकुआँ *bhatkuān*, 1073.
 भटकुआँचा *bhatkuānā*, 1073.
 भटरङ्ग *bhatrang*, 1264.
 भट्टी *bhatti*, 529.
 भट्ठा *bhattha*, 312 920c, 1264.
 भट्ठी *bhatthi*, 371, 454, 562.
 भट्ठीदार *bhatthīdār*, 371.
 भठाएब *bhatthāēb*, 857.
 भठौनी *bhatthauñi*, 1006.
 भंडारी *bhandāri*, 197.
 भड्डर *bhaddar*, 1087.
 भड्डरि *bhaddari*, 1087, 1088.
 भड्कक *bharkachh*, 726.
 भड्काक *bharkāchh*, 726.
 भड्कूई *bharkūi*, 920b.
 भड्भूजा *bharbhūja*, 433.
 भड्की *bhanruki*, 920b.
 भण्टा *bhanta*, 1073.
 भण्डार *bhandār*, 1433.
 भतवान *bhattwān*, 1341.
 भतवानी *bhattwāni*, 1341.
 भतार *bhatār*, 1088, 1274, 1279.
 भतुआ *bhatua*, 1071.
 भत्ता *bhatta*, 252.
 भथखै *bhatkhkhai*, 1286.
 भथकूआँ *bhatkhkūān*, 920c.
 भटर *bhatr*, 1418.
 भटर कराएब *bhatr karāēb*, 1418.
 भट्टरी *bhattari*, 996.
 भट्टया *bhattarya*, 965, 1016.
 भट्टपद *bhattapad*, 1082.
 भनसा *bhansa*, 1248.
 भनसा घर *bhansa ghar*, 1248.
 भनसार *bhansār*, 435.
 भनसारी *bhansāri*, 434.
 भभका *bhabhka*, 713.
 भभरा *bhabhra*, 994.
 भंभरा *bhambhra*, 1249.
 भभरी *bhabhri*, 1272.
 भभरा *bhamra*, 1249.
 भये *bhaye*, 1991.
 भर *bhar*, 262, 867, 1010, 1092, 1174.
 भरकक *bharkachh*, 726.
 भरका *bharka*, 1074.
 भरकाहा *bharkāha*, 1098.
 भरकी *bharki*, 1074.
 भर खुरपी सोहब *bhar kharpī sohāb*, 867.
 भर जाएब *bharjāēb*, 1174.
 भर ठेऊना *bhar thēūna*, 1010.
 भरना *bharña*, 1272.
 भरनी *bharti*, 372.
 भरदीना *bhardīna*, 842.

- भरण *bharan*, 920c.
 भरनठ *bharnath*, 1251.
 भरना *bharna*, 731, 1251, 1477, 1482.
 भरनी *bharni*, 1082.
 भरन्त *bharant*, 1091.
 भरव *bharab*, 1388, 1390.
 भरभँडु *bharbhāṅṛ*, 1075.
 भरल *bharal*, 850, 915.
 भरबन *bharban*, 833.
 भरसलिया *bharsaliya*, 842.
 भरसँय *bharsāin*, 434, 435.
 भरँठ *bharānth*, 1251.
 भराना *bharāna*, 731.
 भरानी *bharāni*, 179.
 भरारव *bharāw*, 731.
 भरारवठ *bharāwath*, 475.
 भररिथ *bharith*, 666.
 भररुका *bharuka*, 713.
 भररुकी *bharuki*, 713.
 भरे *bhare*, 1087.
 भरैठ *bharēth*, 1251.
 भरैठ *bharāith*, 1251.
 भरैया *bharaiya*, 801.
 भँवगरा *bhāwgara*, 1074.
 भँवगरी *bhāwri*, 1332.
 भवानो *bhawāni*, 1456.
 भवँरी *bhawāri*, 1249.
 भसनी *bhasni*, 831.
 भसस *bhasam*, 414.
 भसल *bhasal*, 920c.
 भसुराही *bhasurāhi*, 786.
 भाँ *bhān*, 1085.
 भाद *bhāi*, 1089.
 भाकुर *bhākur*, 1458.
 भाँख *bhankh*, 1074.
 भाँखी *bhānkhī*, 1074.
 भाँग *bhāng*, 1036.
 भागर *bhāgar*, 788.
 भागलपुर *bhāgalpūr*, 1486.
 भाँज *bhānj*, 291, 363, 846, 872, 1201.
 भाँजा *bhānja*, 872.
 भाँजा सिरि *bhānja sire*, 291.
 भाजी *bhāji*, 1001.
 भाँजो *bhānjo*, 846.
 भाँटा *bhānta*, 1073.
 भाँटिन *bhāntin*, 965i.
 भाठ *bhāth*, 802, 901.
 भाठी *bhāthi*, 1264.
 भाँडु *bhāṅṛ*, 713.
 भाँडुठ *bhāwra*, 138.
 भाँडुठ *bhāwra*, 136, 138, 140, 467, 713.
 भाँडुठी *bhāwri*, 495.
 भात *bhāt*, 963, 990, 1084, 1087, 1272, 1286, 1338.
 भादव *bhādab*, 1087.
 भादँ *bhādon*, 1082, 1087, 1088, 1092.
 भाँथी *bhānithi*, 414.
 भाथी *bhāthi*, 414, 510, 554, 560, 545.
 भान *bhān*, 1087.
 भानस *bhānas*, 1248, 1268.
 भानस घर *bhānas ghar*, 1248.
 भार *bhār*, 435, 444.
 भारा *bhāra*, 1483.
 भारी *bhāri*, 657, 737.
 भारो *bhāro*, 444.
 भाल *bhāl*, 972.
 भाल सरी *bhāl sari*, 972.
 भाला *bhāla*, 102.
 भाव *bhāo*, 1479.
 भाव के भाव *bhāo ke bhāo*, 1479.
 भाँवर *bhāwvar*, 912, 1194, 1196, 1332.
 भावग्ली *bhāoli*, 902, 1198, 1221, 1225.
 भाँवाँ डेरा *bhāwān dera*, 1110.
 भास *bhās*, 789, 923.
 भासे *bhāse*, 834.

भिच्छा *bhichchha*, 1203.
 भिठगरा *bhithgara*, 1000.
 भिठारा *bhithāra*, 811.
 भिण्डा *bhinda*, 917, 1050.
 भिण्डी *bhindi*, 1073.
 भितम्भेड़ा *bhitbhera*, 1256.
 भितभेरा *bhitbhera*, 363.
 भिरंगी *bhirngi*, 999.
 भिरुखी *bhirukhi*, 1173.
 भिलोर *bhilor*, 1183.
 भिल्लरि *bhillari*, 1084, 1085.
 भीख *bhikh*, 1203.
 भीजे *bhije*, 737.
 भीजै *bhijai*, 1087.
 भीठ *bhāth*, 784, 802, 811, 1050.
 भीठा *bhātha*, 784, 793, 811.
 भीठो *bhātho*, 784.
 भीड़ *bhūr*, 917.
 भीत *bhāt*, 1235, 1251.
 भीत घर *bhāt ghar*, 1235.
 भीता *bhāta*, 836, 1251.
 भीस *bhis*, 785.
 भूषापग *bhuapāg*, 1272.
 भूँखोखरी *bhuūkhari*, 612.
 भूँ चम्पा *bhuūn champa*, 585b.
 भूँला *bhuūla*, 1074.
 भूँली *bhuūli*, 1074.
 भूँलोठ *bhuūlot*, 1263.
 भूँसीकर *bhuūnsikar*, 966b.
 भूगन्तान *bhugtān*, 1487.
 भूचप्पा *bhuchappa*, 585b.
 भूचम्पा *bhuchampa*, 585b.
 भूजग्ना *bhujna*, 1272.
 भूँजग्ना *bhuūjna*, 433.
 भूँजग्नाठी *bhuūjnāthi*, 56, 439.
 भूँजबन्ता *bhuūjabra*, 1241.
 भूँका *bhutka*, 1073.
 भूँटा *bhutta*, 984.
 भूँकी *bhurki*, 1253.
 भूँकी *bhurki*, 612.

भूँवा *bhurwa*, 1107.
 भूँरिया *bhuriya*, 612.
 भूँरिया *bhuūriya*, 956.
 भूँडा *bhunda*, 1107.
 भूँडी *bhundi*, 729, 1173.
 भूँपो *bhuūpo*, 729.
 भूँतिएलाह *bhutiailāh*, 356.
 भूँदो *bhundo*, 612.
 भूँगन्तान, *bhūghān*, 1485, 1487.
 भूँगन्तान हो गैल *bhūghān ho gail*,
 1185.
 भूँका *bhurka*, 713.
 भूँकी *bhurki*, 713.
 भूँकूट *bhurphūt*, 922.
 भूँर्री *bhurri*, 1074.
 भूँरली *bhurli*, 1005, 1074.
 भूँरहा *bhurha*, 922.
 भूँरियाँ *bhuriyān*, 431.
 भूरिला *bhurila*, 1074.
 भूरिली *bhurili*, 1074.
 भूर्रा *bhurra*, 1014.
 भूँकार *bhūskār*, 895.
 भूँकारी *bhūskāri*, 895.
 भूँखार *bhūskhār*, 895.
 भूँघर *bhūshar*, 895.
 भूँना *bhūnat*, 1023.
 भूँनी *bhūni*, 785.
 भूँरङ्गा *bhūrangā*, 1264.
 भूँसकल *bhūnsakal*, 895.
 भूँरिया *bhūsrīya*, 1264.
 भूँरी *bhūsrī*, 786.
 भूँसौर *bhūnsaur*, 895.
 भूँसौल *bhūnsaul*, 895.
 भूँसौल घर *bhūnsaul ghar*, 895.
 भूँसुलवा *bhūshulwa*, 895.
 भूँसा *bhūssa*, 894, 990, 1001, 1145.
 भूँसा *bhūsa*, 284, 1071, 1074.
 भूँजा *bhūja*, 1272.
 भूँजा *bhūja*, 433, 1272.
 भूँड़ *bhūar*, 922.

भूडा *bhūra*, 1107.
 भूड़ी *bhūri*, 729.
 भूत *bhūt*, 1457, 1458.
 भूनल *bhūnal*, 963, 1272.
 भूनल खिचड़ी *bhūnal khichri*, 963, 1272.
 भूप *bhūp*, 1073.
 भूप सेम *bhūp sem*, 1073.
 भूमि *bhūmi*, 1203.
 भूमि गनेस *bhūmi ganes*, 1203.
 भूर *bhūr*, 156, 922.
 भूरा *bhūra*, 1014, 1052, 1071.
 भूला *bhūla*, 1132.
 भूला जाइल *bhūla jāil*, 1132.
 भूस *bhūs*, 994, 995, 997, 1092.
 भूसा *bhūsa*, 894, 895, 990, 994, 995,
 1004, 1145.
 भूसा *bhūsa*, 894, 1004, 1145.
 भूसा घर *bhūsā ghar*, 895.
 भूसी *bhūsi*, 990, 1183.
 भूसी *bhūsi*, 894.
 भेखरी *bhekhri*, 1183.
 भेंगरिया *bhengariya*, 1075.
 भेंटवाँस *bhentwāns*, 999, 1076.
 भेंङकाबर *bhenrkābar*, 973.
 भेंङपुरे *bheṅdharai*, 1150.
 भेंङवा *bhenra*, 1074, 1104.
 भेंडाड़ी *bhenrāri*, 848.
 भेंड़िहर *bhenrihar*, 488, 1150.
 भेंड़िहार *bheṅrihār*, 1150.
 भेंड़िहारा *bheṅrihāra*, 1150.
 भेनाड़ी *bhenāri*, 848.
 भेमरा *bhemra*, 1074.
 भेलह *bhelahū*, 604.
 भेलै *bhelai*, 1477.
 भेजिये *bhejiye*, 655.
 भेंट *bhent*, 999.
 भेंड *bheṅr*, 1104, 1123.
 भेंडा *bhenra*, 1074, 1123.
 भेंड़िक *bheṅrik*, 1123.
 भेंड़िक बच्चा *bhenrik bachcha*, 1123.

भेंड़ी *bhenri*, 851, 1123.
 भेंड़ी बैसाखोल *bhenri baisāol*, 851.
 भेंड़ी हिराखोल *bhenri hirāöl*, 851.
 भेंड़ो *bheṅro*, 1123.
 भेर *bher*, 832, 1214.
 भेल *bhel*, 864, 957, 987, 990.
 भेली *bheli*, 1014.
 भेंबाँट *bhaibānt*, 1214.
 भेंसलेट *baislet*, 965j.
 भेंसाएब *bhainsāeb*, 1115.
 भेंसाँटा *bhainsānta*, 1139.
 भेंसाँटा *bhainsānta*, 1139.
 भेंसाँघा *bhainsāndha*, 1151.
 भेंयक *bhaiyak*, 1446.
 भैया *bhaiya*, 1088, 1214.
 भैया बाँट *bhaiya bānt*, 1214.
 भैरब *bhairab*, 1456.
 भैरो *bhairo*, 1456.
 भैल *bhail*, 957, 1485.
 भैवध *bhaiwadh*, 1214.
 भेंस *bhains*, 1120.
 भेंसा *bhainsa*, 1120.
 भेंसी *bhainsi*, 1120.
 भोकसवा *bhokaswa*, 1458.
 भोकिला *bhokila*, 954.
 भोकौसा *bhokaua*, 818.
 भोगिला *bhogila*, 1016, 1019.
 भोचरी *bhochri*, 1016, 1019.
 भोजनी *bhojni*, 1197, 1201, 115
 भोजहरी *bhojahri*, 713.
 भोंटिया *bhontiya*, 646.
 भोथरा *bhothra*, 637.
 भोरहा *bhorha*, 984.
 भोराह *bhorah*, 984.
 भोंरियाएल *bhonriyāel*, 1132.
 भोंसौला *bhoṅsaula*, 895.
 भोग *bhog*, 972, 975.
 भोज *bhoj*, 1341, 1345, 1426, 1
 भोड़ *bhor*, 1217.
 भोर *bhor*, 1026, 1076.

भौरा *bhoīra*, 1249.
 भोषा *bhosa*, 1183.
 भौकडा *bhaukatta*, 913.
 भौरन्कली *bhaurnkali*, 595.
 भौरिया *bhaurriya*, 828.
 भौआ *bhauāū*, 1110, 1113.
 भौआ डेर *bhauāū ter*, 1110, 1113.
 भौआ डेर *bhauāū der*, 1110.

भौकी *bhaunki*, 49, 442.
 भौटा *bhaunta*, 898.
 भौठो *bhauntho*, 252.
 भौता *bhaunta*, 252.
 भौती *bhaunti*, 346.
 भौर कली *bhaur kali*, 261.
 भौरते *bhauri*, 1194, 1332.

॥ म ॥

मं *maū*, 1234.
 मप्रदा *māda*, 1272.
 मकरै *makaī*, 983, 984, 1183.
 मकरै के डाँट *makaī ke dānt*, 1183.
 मकड़ा *makra*, 1075.
 मकना *makna*, 1382.
 मकफल *makphāl*, 1481.
 मकरा *makra*, 993, 1183.
 मकर्री *makri*, 7, 331, 346, 375, 555,
 587, 933, 940, 1250.
 मकान *makān*, 1234.
 मकारन्बीर *makārbīr*, 299, 1456.
 मकुना *makuna*, 1129.
 मकुनी *makuni*, 1272.
 मकुन्दी *makundi*, 1272.
 मकुन्दी दाना *makundi dāna*, 1272.
 मकैया *makaiya*, 983.
 मकोय *makoe*, 1073.
 मक्खन *makkhan*, 1166.
 मखदुमाना *makhdumāna*, 1441.
 मखदूम शाह *makhdūm shāh*, 1441.
 मखाना *makhāna*, 1419.
 मगर्जा *magji*, 748.
 मंग्डीका *mangtika*, 762.
 मंग्नी *mangni*, 912, 1196, 1366,
 1483.
 मंग्नी चंग्नी *mangni changni*, 1483.
 मंग्ग्रा *mangra*, 161, 713, 1074,
 1262.

मंग्ग्री *mangri*, 1257.
 मग्वारी *magwāsi*, 335c.
 मग्वो *maghi*, 1049.
 मग्घा *maggha*, 1082, 1084, 1087.
 मग्घा *maghra*, 805, 818.
 मग्घा चास *maghra chās*, 818.
 मग्घवट *maghwat*, 818.
 मग्घा *magha*, 1086.
 मग्घाड़ *maghār*, 805, 818.
 मग्घाड़ जोतब *maghār jotab*, 818.
 मग्घात *maghāt*, 805.
 मग्घार *maghār*, 798, 805.
 मग्घुआ *maghua*, 805.
 मङ्गर *mangar*, 152, 161.
 मचान *machān*, 70, 233, 327, 429,
 890.
 मचिया *machiya*, 632.
 मचोला *machola*, 632.
 मच्छर *machhar*, 1183.
 मच्छकछ *machhkachh*, 1419.
 मच्छकछ ला *machhkachh la*, 1419.
 मच्छरिया *machhariya*, 764.
 मच्छलिया *machhaliya*, 764.
 मच्छली *machhli*, Appendix, 14.
 मच्छुआ *machhua*, 232.
 मच्छती *machhuti*, 1075.
 मजग्ना *majna*, 362.
 मजग्नी *majni*, 575.
 मजग्री *majri*, 1074.

- मजिल *majil*, 1416.
 मजिल ले जानिहार *majil le jānikār*,
 1416.
 मजिलिहा *majiliha*, 1416, 1417.
 मजुसी *majusi*, 322.
 मजूर *majūr*, 420, 1184.
 मजूरा *majūra*, 293, 842.
 मजूरी *majūri*, 1185.
 मझनी *majhni*, 1341.
 मझवा *majhwa*, 332.
 मँझवार *manjhvāra*, 19.
 मझोतर *majhotar*, 33.
 मँझोला *manjholā*, 422.
 मँझोली *manjholi*, 148, 482.
 मँझौटा *manjhautā*, 252.
 मझौतर *majhautar*, 33.
 मञ्जी *manji*, 507.
 मञ्जा *manjha*, 179, 889.
 मञ्जार *manjhār*, 1098.
 मटका *matka*, 713, 1173, 1458.
 मटकी *matki*, 83.
 मटकुरी *matkuri*, 139, 465.
 मटकूही *matkūhi*, 139.
 मटकोड़वा *matkorwa*, 1306, 1311.
 मटकोर *matkor*, 578.
 मटखना *matkhana*, 578.
 मटखभा *matkhabha*, 578.
 मटखम *matkham*, 578.
 मटपर *matpar*, 1247.
 मटमहननी *matmahni*, 143.
 मटर *matar*, 1000.
 मटरा *matra*, 959.
 मटरी *matri*, 1272.
 मटरो *matro*, 1001.
 मटरो साग *matro sāg*, 1001.
 मटहा *matha*, 792.
 मटिखान *matikhān*, 129, 578.
 मटिगर *matigur*, 786.
 मटिया *matiya*, 572.
 मटियार *matiyār*, 578, 786, 802.
 मटियार बाँगर *matiyār bāngar*, 802.
 मटियार भौठ *matiyār bhāth*, 802.
 मटिहम *matiham*, 414.
 मटुका *matuka*, 83, 372, 696, 713.
 मटुकी *matuki*, 308.
 मटोर *mator*, 45, 1052.
 मट्टा *mattha*, 1166.
 मठ *math*, 1234.
 मठगर *mathgar*, 1161.
 मठजावर *mathjāur*, 1272.
 मठना *mathna*, 552.
 मठरना *matharna*, 499.
 मठरनी *matharni*, 523.
 मठार *mathār*, 499.
 मठाहा *mathāha*, 1161.
 मठाही *mathāhi*, 1161.
 मठिया *mathiya*, 757, 768, 1234.
 मठियार *mathiyār*, 1161.
 मट्टा *mattha*, 1272.
 मट्टर *marā*, 72, 407, 879.
 मँट्टर *maṭṭarā*, 1234.
 मट्टु *marar*, 488.
 मँट्टु *manṭṭar*, 1450, 1452.
 मट्टर *marar*, 1075.
 मँट्टर *maṭṭar*, 1217.
 मट्टरा *marra*, 603.
 मट्टरी *marri*, 585a.
 मट्टरो *marro*, 268.
 मँट्टवच *manṭṭvach*, 1201.
 मट्टवा *marwa*, 1051.
 मँट्टवा *manṭṭwa*, 1307, 1355.
 मट्टसटका *marvatka*, 1272.
 मट्टही *marhi*, 1307.
 मट्टिया *mariya*, 523.
 मट्टुषा *marua*, 362, 877, 990, 1257.
 मँट्टुषा *maṭṭrua*, 990, 1257.
 मट्टुषाटी *maruati*, 1183.
 मट्टुका *maruka*, 1234.
 मँट्टेर *manṭṭer*, 1075.
 मट्टैया *maraiya*, 394.

- महङ्गा *marhwa*, 1307, 1308, 1309,
 1310, 1311, 1322, 1326, 1327,
 1828, 1332.
 महङ्गही *marhhi*, 1234.
 मण्डप *mandap*, 1307.
 मण्टर *mantar*, 1000.
 मण्ठा *mantha*, 1272.
 मण्डा *manda*, 823, 955.
 मण्डो जीत *mando jot*, 828.
 मण्डू *mandu*, 1183.
 मण्डू के नारा *mandu ke nara*, 1183.
 मति *mati*, 1113.
 मथई *mathai*, 142.
 मथानी *mathni*, 144, 541, 895,
 1251.
 मथबोझा *mathbojha*, 886.
 मथाई *nathai*, 142.
 मथानी *mathani*, 769.
 मथार *mathar*, 941.
 मदक *madak*, 1033.
 मदत *madat*, 1201.
 मँदरा *mandra*, 203, 204.
 मदाइन *madain*, 1451.
 मदीयान *mediyan*, 1126.
 मधनरी *madhnari*, 372.
 मन *man*, 790, 1263, 1383, 1498.
 मनकाँटा *mankantu*, 640.
 मनकोही *mankorhi*, 1098.
 मनकौनी *mankauini*, 1045.
 मनखप *mankhap*, 903, 1221.
 मनखम *mankham*, 275.
 मनगो *mango*, 1005.
 मनभाई *manjhai*, 341.
 मनचलब *manchalab*, 1399.
 मन्ठीका *manthika*, 903, 1221.
 मनपई *manpai*, 914.
 मनपौषा *manpaua*, 914.
 मनवाँ *manwan*, 808, 1016.
 मनसरा *mansara*, 978.
 मनसरौ *mansari*, 972.
 मनसा राम *mansa ram*, 1456.
 मनहर *manhar*, 1140.
 मनखण्डा *mankhanda*, 903, 1221.
 मनानो दानो *manano dano*, 1456.
 मनिकथम *maniktham*, 275.
 मनिकथम *manikthamh*, 1256.
 मनिहार *manihar*, 561.
 मनी *mani*, 903, 1185, 1221.
 मनी बन्दोबस्त *mani bandobast*, 903,
 1221.
 मनुस *manus*, 1026.
 मनुभग्देवा *manubhagdeva*, 1458.
 मनुभ देव *manubh deo*, 1456.
 मनोरी *manori*, 766.
 मन्तर *mantri*, 1457.
 मन्त्री पूजा *mantri puja*, 1308.
 ममहर *mamhar*, 1298, 1300.
 ममुहर *mamuhar*, 1300.
 ममोरनी *mamorni*, 325.
 मरई *marai*, 1234.
 मरकन *markan*, 1262.
 मरकहा *markaha*, 1098.
 मरकी *marki*, 912.
 मरकी गरकी *marki gurki*, 912.
 मरखण्डा *markhanda*, 1098.
 मरखन *markhan*, 1098.
 मरखनो *markhano*, 1098.
 मरखाह *markhah*, 1098.
 मरखट *markhat*, 1418.
 मरखट्टी *markhatti*, 1418.
 मरखिडिया *markhiriya*, 1458.
 मरखवा *marakhwa*, 1397, 1400.
 मरजाद *marjad*, 1290, 1339.
 मरजाद राखब *marjad rakhab*, 1339.
 मरतबान *martaban*, 713.
 मरतवान *martawan*, 713.
 मरथम *marthamh*, 258, 275.
 मरद *marad*, 1274.
 मरदाना *mardana*, 1254.
 मरदानी *mardani*, 726, 1254.
 मरदावा *marदावा*, 1274.
 मरन *maran*, 789.

मरुवट *marvat*, 1209c.
 मरुचिन्ना *marhinna*, 1074, 1077.
 मरुहेना *marhena*, 1077.
 मरा *mara*, 1076, 1077.
 मराइल *marāil*, 1004.
 मराण्ल *marāñl*, 1076.
 मराह *marāhh*, 1397, 1400.
 मरिखर *marikhar*, 33.
 मरिचा *maricha*, 1073.
 मरिषा *marīya*, 233, 397, 410, 523,
 541, 552.
 मरी *mari*, 1074, 1094.
 मरुचा *marua*, 1252, 1257.
 मरुका *maruka*, 71, 879.
 मरेया *mareya*, 233, 523.
 मरेन *mareñ*, 1075.
 मरै *marai*, 1234.
 मरोह *marochha*, 1397.
 मरौञ्चती *marauati*, 1217.
 मरौटी *marauti*, 1209c.
 मर्रा *marra*, 72.
 मलङ्कङ्गनी *malkangni*, 1045.
 मलङ्काठी *malkāthi*, 347, 348, 351.
 मलङ्कौनी *malkauni*, 1045.
 मलङ्गिया *malangiya*, 680.
 मलङ्गिया थारी *malangiya thāri*, 680.
 मलङ्गुजारी *malgujāri*, 1207, 1220.
 मलङ्ग *malang*, 235.
 मलङ्गदहिया *maldahiya*, 1057.
 मलङ्गदहिया कनकपुरिया *maldahiya
 kanakpuriya*, 1057.
 मलङ्गानो *maldāno*, 1456.
 मलङ्गमार *malmār*, 1477.
 मलङ्गमास *malmās*, 1081.
 मलङ्गवा *malwa*, 24, 238, 663, 713,
 719, 1257.
 मलङ्गसी *malasi*, 663.
 मल्ला *malāi*, 1165.
 मल्लाह *malāh*, 1456.
 मल्लिकथम *maliktham*, 258.
 मल्लिकथम्भ *malikthambh*, 1256.

मल्लिकार *malikāi*, 1201.
 मल्लिकार चुटकी *malikāi chutki*,
 1201.
 मल्लिया *malīya*, 663, 701, 713.
 मल्लीदा *malīda*, 1384.
 मलुआ *malua*, 1023.
 मलु *malau*, 110.
 मल्लिया *malhiya*, 701.
 मवेशी *maveshi*, 1094.
 मसक *masak*, 655, 720.
 मसङ्कली *maskali*, 602.
 मसङ्गूल *masūl*, 238.
 मसङ्गद *masnad*, 637.
 मसर *masar*, 959.
 मसाहू *masārhu*, 742.
 मसाँत *masānt*, 1499.
 मसान *masān*, 1456.
 मसालङ्गी *masālgī*, 720.
 मसालङ्गार *masāldār*, 1023.
 मसाला *masāla*, 423, 1119, 1267.
 मसाह *masāh*, 824, 981.
 मसाह करव *masāh karab*, 981.
 मसियार *masiyār*, 1087.
 मसी *masi*, 1183.
 मसुरिया *masuriya*, 985.
 मसुरिया जनै *masuriya janer*, 985
 987.
 मसुरी *masuri*, 998.
 मसूर *masūr*, 998.
 मसूल *masūl*, 1488.
 महङ्कार *mahkār*, 299.
 महङ्कार बीर *mahkār bīr*, 299.
 महङ्कौआ *mahkaua*, 1023.
 महङ्गाव *mahtāb*, 585.
 महङ्गाबी *mahtābi*, 585.
 महङ्गाआडा *mahtāra*, 1217.
 महङ्गातों *mahton*, 1217, 1288, 1450,
 1452.
 महङ्गिन दाई *mahtin dāi*, 1456.
 महङ्गदेवा *mahdeva*, 19, 938.
 महङ्ग *mahan*, 142, 251, 256, 273.

महन भोग *mahan bhog*, 1272.
 महनिया *mahanīya*, 321.
 महनिया हौद *mahanīya haud*, 321.
 महनी *mahni*, 144.
 महप्पा *mahappha*, 247.
 महब *mahab*, 142.
 महन्माया *mahmāya*, 1175, 1456.
 महर *mahar*, 1349, 1362, 1363.
 महरन्दार *mahardār*, 373.
 महन्नन *mahrān*, 1161.
 महन्नम *mahrām*, 744.
 महन्नाह *mahrāi*, 1154.
 महन्हु *mahrū*, 1033.
 महल *mahal*, 142.
 महन्हुल *mahsūl*, 1488.
 मँहा *maūha*, 995.
 महाइ *mahāi*, 142, 321.
 महाइ के हौज *mahāi ke hauj*, 321.
 महाजन *mahājan*, 1456, 1461, 1481.
 महाजनी *mahājni*, 1461.
 महाजाल *mahājāl*, 646.
 रुहाड़ा *mahāra*, 138.
 मँहाड़ा *maūhāra*, 143.
 महादे *mahāde*, 893.
 महादेखो *mahādeo*, 19.
 महादेब *mahādeb*, 893, 1456.
 महादेवा *mahādewa*, 19, 938.
 महान *mahān*, 144, 1450.
 महाबाहन *mahābāhan*, 1425.
 महाबीर *mahābīr*, 1456.
 मँहा मूंग *maūha mung*, 995.
 महार *mahār*, 912.
 महाल *mahāl*, 1499.
 महि *mahi*, 1087.
 महिनवारी *mahinwāri*, 1185.
 महिना *mahina*, 1081.
 महिना *mahinna*, 1081, 1185.
 महिया *mahiya*, 1015, 1161.
 महियाउर *mahiyāūr*, 1272.
 महिस *mahis*, 1120.

महिसा *mahisa*, 1120.
 महिची *mahīsi*, 1120.
 महि *mahi*, 142, 1272.
 महिना *mahina*, 1081.
 महुक *mahuak*, 1338.
 महुवर *mahuar*, 1135, 1272.
 महुवा *mahua*, 372, 1045.
 महुगोल *mahugol*, 1135.
 महुलखा *mahulakha*, 1139.
 महु *mahu*, 1045.
 महेर *maher*, 1272.
 महेला *mahela*, 1119.
 महौनी *mahouni*, 144.
 माइ *māi*, 1433, 1456.
 माँ *māin*, 639.
 माइन *māin*, 639.
 माउग *māug*, 1275.
 म्हाँ *māūon*, 1458.
 माख *mākḥ*, 1084.
 माँग *māng*, 235.
 माँगन *māngan*, 912, 1198.
 माँगनी *māngni*, 1201.
 माँगी *māngi*, 235, 335c.
 माँगे *māngre*, 1025.
 माघ *māgh*, 1082, 1092.
 माघी *māghi*, 818.
 माघी चास *māghi chās*, 818.
 माँच *māuch*, 70, 429.
 माँची *māuchi*, 182.
 माँजन *māujan*, 362.
 माँजी *mānji*, 507.
 माजूस *mājūm*, 1036.
 माकी *mākhi*, 990.
 माँकी *matukhi*, 1074.
 माँक *mānjḥ*, 1248.
 माँकघर *mānjghar*, 1248.
 माँका *mānjha*, 179, 214, 224, 195,
 279, 362, 431, 611, 933, 1368,
 1379.
 माँकी *mānjhi*, 236, 507.

माढ *māt*, 77, 83, 310, 372, 505.
 माँड *mānt*, 505, 713.
 माठी *māti*, 1089, 1306.
 माठ *māth*, 505, 1161.
 माठा *mātha*, 1161, 1166, 1272.
 माइ *mār*, 991.
 माँइ *mānr*, 362, 1272.
 माइव *mārab*, 1051.
 माडा *māra*, 630, 1178.
 माडा झुली *māra phulli*, 1178.
 माडो *māro*, 1051.
 माँडो *māvro*, 1051, 1234, 1307.
 मादा *mārha*, 991.
 माँदा *mānrha*, 991.
 माता *māta*, 1140, 1456.
 माता दाइ *māta dāi*, 1456.
 मात्रिक *mātrik*, 1298.
 माँथ *mānth*, 9, 941, 1251.
 माथा *mātha*, 335c.
 माँथा *mānthu*, 9, 408.
 माँदर *māndar*, 259, 271.
 माधव *mādhav*, 688.
 माधव-सिद्धी *mādhav singhi*, 688.
 माघवा *mādhwa*, 975.
 मान *mān*, 849.
 मानजन *mānjan*, 1450, 1452.
 मानिकथम *māniktham*, 275.
 मनिखम *mānikham*, 275.
 माफ *māph*, 1217, 1230.
 माफी *māphi*, 912, 1209b, 1217.
 मामस *māmas*, 788.
 मायू *māyūn*, 1368.
 मार *mār*, 655, 1078, 1085, 1120.
 मारन्तौल *mārtaul*, 388, 397, 589.
 मारव *mārab*, 1098, 1246.
 मारल *māral*, 859, 1004, 1011.
 मारल गेल *māral gel*, 1004.
 मारसा *mārsa*, 1074.
 मारा *māra*, 1072.
 मारि *māri*, 1272.

मारी *māri*, 726 (note).
 मारे *māre*, 1089.
 माल *māl*, 324, 347, 972, 97
 1028, 1029, 1094, 1202, 122
 1272, 1456, 1488.
 मालगुजारी *mālgujāri*, 1207, 1214
 मालग्जादी *māljādi*, 1183.
 माल जाल *māl jāl*, 1094.
 माल रुडी *māl jhari*, 323.
 माल देही *māl dehi*, 973.
 माल पूषा *māl pūa*, 1272.
 माल भोग *māl bhog*, 972.
 माल मेज *māl mej*, 324.
 मालग्वा *mālwa*, 1087.
 माला *māla*, 24, 566, 663, 757
 765, 781, 1257, 1354.
 मालिक *mālik*, 1208.
 माली *māli*, 24.
 माल्ह *mālh*, 347.
 मास *mās*, 1081, 1086, 1087, 1089
 माँस *māns*, 1081, 1085.
 मास कलाइ *mās kalāi*, 996.
 मासा *māsa*, 1498, 1499.
 मासी *māsi*, 1043.
 माँह *mānh*, 1248.
 माँह घर *mānh ghar*, 1248.
 माही *māhi*, 1232.
 माँही *māhi*, 639.
 मिँजनी *minjni*, 887.
 मिमगरा *mijhara*, 1019.
 मिठिया *mitiya*, 713.
 मिट्टी *mitti*, 786, 1429, 1431.
 मिट्टि देव *mitti dev*, 1429, 1431.
 मिठाइ *mithāi*, 1014, 1440.
 मिठुर *mithur*, 1163.
 मिनी *mitti*, 1487.
 मिनहै *minhai*, 1209b.
 मिमियाइ *mimiyāi*, 1045, 1458.
 मिमियाइ के तेल *mimiyāi ke tel*, 101
 1458.

मियादी *miyādi*, 1487.
 मिरगिडाह *mirgidāh*, 1082.
 मिरगसिरा *mirgsira*, 1082, 1084.
 मिरगौ *mirgi*, 1177.
 मिरग्चा *mircha*, 1073.
 मिरग्चाई *mirchāi*, 1073.
 मिरग्जई *mirjāi*, 728, 1272.
 मिरग्जापुरी *mirjāpuri*, 680.
 मिरग्तवान *mirtagvān*, 713.
 मिरग्ला *mirḷa*, 507.
 मिरगसिकार *mirsikār*, 381.
 मिराद्ब *mirāḍb*, 1332.
 मिरिच *mirich*, 1073.
 मिलकियत *milkiyat*, 1207.
 मिलनी *milni*, 1339.
 मिलब *milab*, 1343.
 मिला *mila*, 1485.
 मिलाएब *milāeb*, 1343.
 मिलान *milān*, 1485.
 मिलाप *milāp*, 1159.
 मिला लेब *mila leb*, 1485.
 मिलावा *milāva*, 1339.
 मिलिट *milīt*, 282.
 मिलौना *milāuna*, 575.
 मिसगिरी *mistiri*, 389.
 मिसरी *misri*, 1014.
 मिसिरी *misiri*, 1062.
 मिसिरी कन *misiri kan*, 1062.
 मिसर *mistar*, 427.
 मिसिरी *mistiri*, 420.
 मिस्री *missi*, 1384, 1483.
 मिहतर *mihtar*, 1197.
 मीठा *mīṭha*, 372, 1365.
 मीठा चाउर *mīṭha chāur*, 1365.
 मीठी *mīṭhi*, 1272, 1377.
 मीठी कँडूरी *mīṭhi kaṇḍūri*, 1377.
 मीठी पूरी *mīṭhi pūri*, 1272, 1377.
 मीड़ा *mīra*, 894.
 मीन *mīn*, 990.
 मीयाँ *miyān*, 1376.

मीर फचुला *mīr phāula*, 1456.
 मील *mīl*, 1492.
 मीलन *mīlan*, 1339.
 मीहँ *mīhān*, 889.
 मीहँ *mīhān*, 889.
 मुखल *mūal*, 1077.
 मुखला *mūala*, 414.
 मुखार *mūār*, 1074, 1077.
 मुदल *mūd*, 1118.
 मुका *mukka*, 1249, 1253.
 मुखसुध *mukhsudh*, 1016.
 मुखसुधि *mukhsudhi*, 1056.
 मुखसुधी *mukhsudhi*, 1056.
 मुगदर *mugdar*, 102.
 मुंगरा *muṅra*, 106, 431, 457, 390,
 1262.
 मुंगरी *muṅri*, 87, 106, 124, 555,
 390, 781.
 मुंग्या *muṅya*, 755.
 मुङ्ग *muṅg*, 994, 995.
 मुङ्गर *muṅgar*, 886n.
 मुङ्गा *muṅga*, 1073.
 मुज्वानी *mujwāni*, 815.
 मुज्जवान *mujjvān*, 815.
 मुजेरा *mujera*, 1461, 1477, 1481.
 मुटसुर *mutmur*, 1183.
 मुटनी *mutni*, 973.
 मुट्टा *mutṭha*, 882, 1489.
 मुट्ठी *mutṭhi*, 337.
 मुठरा *mutṭha*, 225, 1106.
 मुठरिया *mutṭhariya*, 1106.
 मुठरी *mutṭhi*, 1272.
 मुठवारा *mutṭvāra*, 335g.
 मुठाल *mutṭāl*, 1106.
 मुठिया *mutṭhiya*, 7, 89, 1106.
 मुठैल *mutṭhail*, 1106.
 मुङ्कटन्वा *muṅkatva*, 1435.
 मुङ्गला *muṅḷa*, 956, 1107.
 मुङ्गली *muṅḷi*, 956.
 मुङ्गवार *muṅvār*, 269.

- मुङ्ग्वारी *murvadri*, 256, 269.
 मड़िया *muriya*, 414, 987.
 मुड़िया *murriya*, 956.
 मुड़ियारी *muriyāri*, 1011.
 मुड़ियारी मारल *muriyāri mārāl*,
 1011.
 मुँडिलन्वा *murilica*, 956.
 मुँडेडा *munrera*, 1107.
 मुड़ेर *murer*, 939.
 मुँड़ेरा *munvera*, 939.
 मुँड़ेरी *mureri*, 939.
 मुण्डा *munda*, 725, 1107.
 मुण्डा *mundha*, 749.
 मुदती *mudati*, 1487.
 मुँदरी *mundri*, 60, 756, 769.
 मुदेखौनी *mudekhouni*, 1347.
 मुदेखी *mudekhi*, 1347.
 मुद्धी *muddhi*, 115.
 मुनगा *munga*, 1073, 1183.
 मुनधी *mundhi*, 115.
 मुनगुन *mungun*, 1183.
 मुनगहर *munhar*, 77.
 मुन्दन *mundan*, 84, 554.
 मुन्दा *munda*, 860.
 मुन्धी *mundhi*, 767.
 मुरर *murāi*, 1073.
 मुरका *murka*, 1074, 1183.
 मुरघटिया *murghatiya*, 1418.
 मुरघट्टी *murghatti*, 1418.
 मुरग्नचिन *murtahin*, 1481.
 मुरती *murti*, 777.
 मुरथारी *murthāri*, 638.
 मुरदन्धड़ी *murdhatti*, 1418.
 मुरदारी *murdāri*, 1139.
 मुरधी *murdhi*, 975.
 मुररा *murra*, 585.
 मुररी *murri*, 1272.
 मुरहा *murha*, 585.
 मुरार *marāi*, 1073, 1089.
 मुरिया *muriya*, 1074.
 मुँरिया *munriya*, 343.
 मुँरी *mūri*, 343.
 मुरेठा *murētha*, 724.
 मुरेना *murēna*, 1183.
 मुरेरा *murera*, 269.
 मुल्तान *multan*, 1087.
 मुल्ली *mulli*, 1073.
 मुशाता *mushāta*, 1361, 1385.
 मुसद *musad*, 457.
 मुसरा *musra*, 416, 431, 464, 610
 मुसहर *mushar*, 1203, 1429, 143.
 मुसुकाप्र *musukāe*, 1088.
 मुह *muh*, 301.
 मुँह *mūh*, 81, 301, 557, 454, 6
 1247, 1428.
 मुँहखड़ *muhkhar*, 79.
 मुहचूर *muhchūr*, 963.
 मुँहड़ा *muhra*, 186.
 मुँहड़ा के नारी *muhra ke nāri*, 2
 मुँहथपड़ा *muhthapra*, 193.
 मुँहथोपड़ा *muhthopra*, 193.
 मुँह देखन *muh dekhān*, 1428.
 मुँहपसिजा *mūhpasija*, 1173.
 मूए *mūe*, 1084.
 मूंग *mūng*, 995.
 मूंगा *mūnga*, 755, 966c.
 मूज *mūnj*, 815, 1422.
 मूठ *mūth*, 7, 29, 88, 89, 398, F
 1434, 1437.
 मूँठ *mūnth*, 1433.
 मूठ पूजा *mūth puja*, 1434.
 मूठ लागल *mūth lāgal*, 1437.
 मूठा *mūtha*, 29, 543, 597, 882.
 मूठी *mūthi*, 88.
 मूड़ *mūr*, 269.
 मूँड़ *mūnr*, 274.
 मूड़ा *mūra*, 414, 1107.
 मूँड़ा *mūnra*, 274, 1107.
 मूरी *mūri*, 343, 414.
 मूँड़ी *mūnri*, 251, 274.

मूरु *mūrk*, 1010.
 मूरुहा *mūrha*, 585, 939.
 मूरुही *mūrhi*, 414, 726, 1272.
 मूरुत *mūt*, 848.
 मूरुंदन *mūndan*, 81.
 मूरु *mūr*, 1073, 1475.
 मूरुत *mūrat*, 777.
 मूरुी *mūri*, 1119.
 मूरुो *mūro*, 1073.
 मूरुल *māl*, 1082, 1475.
 मूरुली *mūli*, 1073.
 मूरुसर *mūsar*, 431, 464, 610, 617.
 मेकराज *mekrāj*, 474, 588.
 मेखाना *meāna*, 247.
 मेखाना *meñāna*, 247.
 मेखार *meār*, 639.
 मेखारी *mekhāri*, 388.
 मेघरा *meghra*, 161.
 मेठहर *meñtahar*, 1247.
 मेठिया *metiya*, 136, 713.
 मेड़रा *menrra*, 936.
 मेड़रा *menrra*, 585a.
 मेड़राय *meñrvāy*, 1089.
 मेड़राया *menraruā*, 414.
 मेड़राया भाँची *menraruā bhāñthi*,
 414.
 मेड़वा *mendhwa*, 1104.
 मेड़नी *medni*, 1037, 1129.
 मेमना *memna*, 1122, 1123.
 मेमनी *memni*, 1122.
 मेरखुन *merkhun*, 1272.
 मेलवानो *melwāni*, 801, 952.
 मेलान *melān*, 918.
 मेलानी *melāni*, 801.
 मेल्हनी *melhni*, 230.
 मेहटा *mehta*, 889.
 मेहटा *menhta*, 889.
 मेहतर *mehtar*, 1452.
 मेहरारू *mehrāru*, 1275.
 मेहराव *mehrāv*, 188.

मेहरी *mehri*, 1276.
 मेहिवाटी *meñhibāti*, 677.
 मेहियाँ *meñhiyān*, 889.
 मेहियाँ बैल *meñhiyān bail*, 889.
 मेहौटी *meñhauti*, 889.
 मेँ *meñ*, 69, 655, 741, 478, 904,
 990, 1020, 1084, 1088, 1098,
 1263, 1275, 1350.
 मेख *mekh*, 1449.
 मेघ *megh*, 1092.
 मेघा *megha*, 1087, 1088.
 मेघू डाक *meghu dāk*, 1456.
 मेँच *meñch*, 633.
 मेज *mej*, 324.
 मेटा *meta*, 713.
 मेटी *meti*, 713.
 मेटुम *metum*, 414.
 मेँद *menr*, 832, 953.
 मेहन *merhan*, 33.
 मेँहा *menrha*, 889.
 मेथी *methi*, 1073.
 मेँथी *meñthi*, 1073.
 मेदनि *medani*, 1037.
 मेरू *meru*, 1033.
 मेल *mel*, 1042.
 मेँच *meñch*, 889.
 मेहा *meha*, 889.
 मेँहा *meñha*, 889.
 मेँगिरी *meñgiri*, 403.
 मेँजनी *meñjni*, 887.
 मेँलखन्ना *meñlkhanna*, 307.
 मेँका *meñka*, 1297.
 मेँगर *meñgar*, 161.
 मेँदा *meñda*, 1272.
 मेँन *meñn*, 639, 1103, 1346.
 मेँना *meñna*, 1103, 1113.
 मेँया *meñya*, 1456.
 मेँरन *meñran*, 33.
 मेँल *meñl*, 1015, 1492.
 मेँला *meñla*, 848, 1015.

- मोषार *moār*, 1077.
 मोकदम *mokadam*, 1217.
 मोकररी *mokarari*, 1212.
 मोकरी *mokri*, 1209e.
 मोखड़ा *mokhra*, 924.
 मोखड़ी *mokhri*, 414.
 मोखतार *mokhtār*, 1183, 1208.
 मोखतियार *mokhtiyār*, 1208.
 मोचट्टी *mochutti*, 1075.
 मोचना *mochna*, 383, 474.
 मोजम्मा *mojumma*, 113.
 मोजरी *mojri*, 119.
 मोटन्दरवा *motdharwa*, 943.
 मोटरी *motri*, 318.
 मोटवाहा *motwāha*, 944.
 मोटवाही *motwāhi*, 801.
 मोटवा *motha*, 938, 941, 1097.
 मोटवा जोड़ी *motha jori*, 941.
 मोटवा बरध *motha baradh*, 1097.
 मोटिया *motiya*, 730.
 मोठड़े किनाड़ी *mothre kināri*, 225.
 मोठिया *monrhiya*, 631.
 मोतरफा *motarpha*, 1201; Appendix, 14.
 मोतम्मना *motmannu*, 1394.
 मोतलके *motalke*, 1233.
 मोतरफा *motharpha*, 1201.
 मोतिया *motiya*, 533.
 मोथपड़ा *mothapra*, 225.
 मोथापड़ा *mthāpra*, 193.
 मोनाफा *monāpha*, 1475.
 मोफरीद *mophrūd*, 1468 a & b, 1470, 1471; Appendix, 3, 9.
 मोरका *morka*, 1234.
 मोरनी *morni*, 238, 325.
 मोरवार *morwār*, 269.
 मोरवाह *morwāh*, 269, 283, 295, 945.
 मोरवाह *monrwāh*, 283, 295.
 मोरसा *morassa*, 475.
 मोरहन *morhan*, 1022, 1024, 1025, 1194.
 मोरानी *morāni*, 954.
 मोरिया *moriya*, 233.
 मोल्हकी *molhaki*, 1468c, 1472; Appendix, 13.
 मोहणा *mohkhā*, 81, 301, 414.
 मोहड़ा *mohra*, 562.
 मोहनम्भा *mohanthambha*, 274.
 मोहदेखार *mohdekhāi*, 1347.
 मोहनदी *mohandi*, 159.
 मोहनरी *mohanri*, 159, 160.
 मोहब्बत *mohabbat*, 1252.
 मोहरकन *moharkan*, 540.
 मोहरम *moharam*, 1449.
 मोहरम के सिपाही *moharam ke sipā* 1449.
 मोहरा *mohra*, 186.
 मोहरिदार *mohrūdār*, 727.
 मोहरी *mohri*, 1125.
 मोहली *mohli*, 538.
 मोहली लोहार *mohli lohār*, 538.
 मोहान *mohān*, 365.
 मोहरी *mohri*, 94.
 मोहैन *mohain*, 256.
 मोका *moka*, 922.
 मौका *mouka*, 1249.
 मोख *mokh*, 1250.
 मोखा *mokha*, 1250.
 मोच *moch*, 984.
 मोचा *mocha*, 984.
 मोची *mochi*, 479.
 मौची *monchi*, 479.
 मौह *monchh*, 984.
 मोहा *mochha*, 984.
 मोजर *mojar*, 119.
 मोट *mot*, 14, 720, 936, 941, 1145.
 मोट *mont*, 936.
 मोट चलाएब *mot chalāeb*, 941.
 मोटि *moti*, 720, 936.

मोटेलेँ *motailen*, 1002 (footnote).
 मोढा *morha*, 186.
 मोँदा *mor'ha*, 631.
 मोही *morhi*, 990.
 मोती *moti*, 753, 765.
 मोती चूर *moti chūr*, 1272.
 मोती माला *moti māla*, 765.
 मोती राम *moti rām*, 1456.
 मोथा *moth*, 997.
 मोथा *motha*, 1183.
 मोँथा *montha*, 1075.
 मोँथी *mothi*, 997.
 मोदक *modak*, 1272.
 मोना *mona*, 656.
 मोमिन *momin*, 355.
 मोर *mor*, 585*f*, 664 (footnote).
 मोर चक्कर *mor chakkar*, 585*f*.
 मोर बाज *mor bāj*, 585*f*.
 मोरी *mori*, 323, 823, 862, 963, 982,
 1435.

मोरी पेटारी *mori petāri*, 963.
 मोल *mol*, 1113, 1419.
 मोहन *mohan*, 256, 755.
 मोहन माला *mohan māla*, 755.
 मोहर *mohar*, 755, 918, 1284.
 मोहर देन *mohar den*, 1284.
 मोहर माला *mohar māla*, 755.
 मौनिया *mauniya*, 44, 442.
 मोरूसी *maurūsi*, 1215.
 मौषार *mauār*, 1154.
 मौगी *maugi*, 1275.
 मौजा *mauja*, 1499.
 मौन *maan*, 713.
 मौना *mauna*, 1075.
 मौनी *mauni*, 442.
 मौनी *maunni*, 44, 656.
 मौर *maur*, 1119, 1321, 1326.
 मौरी *mauri*, 1326.

॥ य y ॥

यों *yon*, 356.

॥ र r ॥

रई *rai*, 1037, 1272.
 रकसा *raksa*, 985, 991.
 रकसी *raksi*, 985.
 रकेबी *rakebi*, 713.
 रखनी *rakhni*, 1280.
 रखनबह *rakhhbah*, 1087.
 रखनवार *rakhwār*, 870.
 रखनवारी *rakhwāri*, 870.
 रखनवाही *rakhwāhi*, 870.
 रजात *rakhāt*, 1147.
 रखाँत *rakhānt*, 877, 1147.
 रखेलिन *rakhelin*, 1280.
 रखेली *rakheli*, 1280.

रखौर *rakhaur*, 786.
 राग *rag*, 1486.
 रंगरेज *rangrej*, 504.
 रंगरेजी *rangreji*, 504, 509.
 रंगसाज *rangsāj*, 504, 509.
 रंगहन्री *rangehri*, 535.
 रघुनी डाक *raghuni dāk*, 1456.
 रघू *raghu*, 1456.
 राजपुत *rajpūt*, 964.
 राजार *rajāi*, 731.
 राजील *rajil*, 1217.
 रञ्ची *ranchi*, 1045.
 रटनी *ratni*, 1183.

- रट्वा *ratwa*, 967h.
 रँङ्गसार *rañrsār*, 1426.
 रँङ्गसारी *rañrsāri*, 1426.
 रहिया *rahīya*, 808, 1016, 1019.
 रखा *randa*, 1278.
 रखी *randi*, 1280.
 रतञ्जमा *ratjagga*, 1372.
 रतञ्जल *ratrul*, 1011.
 रताप्रल *ratāēl*, 1011.
 रतार *ratār*, 1058.
 रतालू *ratālu*, 1058.
 रत्ती *ratti*, 1498, 1499.
 रथ *rath*, 148, 206.
 रदा *radda*, 1251.
 रनकिल्ली *rankilli*, 164, 929.
 रनकी *ranki*, 611.
 रन्थ *ranth*, 148, 206.
 रन्थी *ranthi*, 1416.
 रन्दा *randa*, 399, 401, 602.
 रफ्तनी *raphṭani*, 1488.
 रफ़ीदा *raphīda*, 451.
 रबी *rabi*, 858.
 रबिल *rabil*, 426.
 रमकरवा *ramkarwa*, 713.
 रमचुक्का *ramchukka*, 713.
 रमजूषा *ramjūā*, 973.
 रमनिया *ramaniya*, 978.
 रमरम्मी *ramrammi*, 1339.
 रमुनी *ramuni*, 972.
 रम्पा *rampa*, 481.
 रम्बा *ramba*, 399.
 ररेठा *rarethā*, 896, 994.
 रवाँ *rawāñ*, 1275.
 रवाइसवाला *rawāiswāla*, 580.
 रस *ras*, 366, 568, 1014, 1015, 1272.
 रस गोला *ras gola*, 1272.
 रसघारा *rasghāra*, 270.
 रसजाउर *rasjāūr*, 1440.
 रसखन्ना *raskhanna*, 284.
 रसपाल *raspāl*, 585.
 रसपैन *raspain*, 269.
 रसबन्धा *rasbanta*, 595.
 रसगरी *rasri*, 115, 145, 1492.
 रसवत *raswat*, 234.
 रसाप्रल *rasāēl*, 1011.
 रसिदाना *rasidāna*, 1198.
 रसिदावन *rasidāwan*, 1198.
 रसिया *rasīya*, 1272.
 रसियाव *rasiyāv*, 1272.
 रसीद *rasīd*, 1467, 1488.
 रसुअर *rasuar*, 1203.
 रसुन *rasūn*, 1073.
 रसुली *rasūli*, 1203.
 रसेइ *raser*, 270.
 रसोइया *rasoiya*, 1248.
 रसोइया घर *rasoiya ghar*, 1248.
 रसोइ *rasoi*, 1268.
 रसोली *rasoli*, 140.
 रसा *rassa*, 115, 184, 375, 1272.
 रसी *rassi*, 115, 196, 123, 464, 613, 1492.
 रसुन *rassun*, 1073.
 राहट *rahat*, 947.
 राहटवार *rahatwār*, 533.
 राहटा *rahta*, 339.
 राहना *rahna*, 478.
 राहर *rahar*, 994, 995, 1073.
 राहरिया *rahariya*, 1073.
 राहरिया सेम *rahariya sem*, 1073.
 राहरी *rahri*, 994.
 राहरेठा *rahretha*, 994.
 राहःरेठा *rahraitha*, 994.
 राहल *rahal*, 987, 1043, 1234.
 राहाठ *rahāth*, 994.
 राहिला *rahila*, 1002.
 राही *rahi*, 144.
 राहे *rahe*, 1085, 1088.
 राहेठा *rahetha*, 896, 994.
 राइ *rāi*, 1045, 1089, 1402.
 राइस *rāis*, 137, 140, 713.

राउत *rāut*, 1456.
 राज *rāu*, 1084.
 राकस *rākas*, 1458.
 राँकी *rānki*, 371.
 राख *rākh*, 849.
 राखब *rākhab*, 1339.
 राखिये *rākhiye*, 655.
 राँगा *rānga*, 511.
 राँगी *rāngi*, 969.
 राज *rāj*, 420, 1207.
 राज मजूर *rāj majūr*, 420.
 राज मिस्तिरी *rāj mistiri*, 420.
 राजा *rāja*, 1085, 1092, 1450.
 राटन *rātan*, 640, 1183.
 राड़ *rār*, 1217.
 राँड़ *rānr*, 1088, 1279.
 राड़ जाति *rār jāti*, 1217.
 राड़ भोर *rār bhor*, 1217.
 राँड़ा *rāūra*, 1278.
 राड़ी *rāri*, 1075, 1183.
 राही *rārhi*, 1183.
 रात *rāt*, 965, 966, 1087, 1091.
 रातल *rātal*, 640.
 रातुक *rātuk*, 1088, 1091.
 रातुल *rātul*, 640.
 रादा *rāda*, 1251.
 राधे चक्कर *rādhe chakkar*, 585.
 रान *rān*, 289, 1272.
 रानी *rāni*, 1084.
 रान्ह *rānh*, 289.
 रापी *rāpi*, 481.
 राँपी *rānpi*, 481.
 राफ *rāph*, 1485.
 राफ साफ *rāph sāph*, 1485.
 राब *rāb*, 311, 1014, 1272.
 राम *rām*, 965c, 978, 1062, 1073.
 राम करन्हनी *rām karhanni*, 966d.
 राम केशौर *rām kesaur*, 1062.
 राम गोसाँई *rām gosāin*, 1456.
 राम ठाकुर *rām thākur*, 1456.

राम तरोर *rāmtaroi*, 1073.
 राम दुलारी *rām dulāri*, 965c, 966e.
 राम दुल्लर *rām dullar*, 978.
 राम परोर *rām paror*, 1073.
 राम बीर *rām bīr*, 1456.
 राम रुहर *rām ruhar*, 1073.
 राम राम *rām rām*, 1339, 1419.
 राय *rāy*, 655.
 रारी *rāri*, 815.
 राल *rāl*, 737.
 रावा *rāwa*, 1014
 रास *rās*, 82, 137, 226, 893, 1015,
 1094, 1343, 1394.
 रास कड़ी *rās kari*, 226.
 रास के रस *rās ke ras*, 1015.
 रास पर लेब *rās par leb*, 1394.
 रास बरग बैस गेल *rās barag bais gel*,
 1343.
 रासा *rāsa*, 1272.
 रासि *rāsi*, 137.
 राह *rāh*, 456.
 राहत *rāhat*, 920.
 राहठ *rāhath*, 994.
 राहर *rāhar*, 994.
 राहरि. *rāhari*, 994.
 राहिन *rāhin*, 1481.
 राऊ *rāhu*, 1456.
 रिकाबी *rikābi*, 449, 711, 713.
 रिकेबी *rikebi*, 713.
 रिकींच *rikaunch*, 1272.
 रिनिहा *riniha*, 1461.
 रिरियाघ *ririyaḡ*, 1089.
 रिहम *riham*, 1372.
 रीत *rit*, 1381.
 रीत के जोड़ा *rit ke jora*, 1381.
 रुआरा *ruāra*, 1075.
 रुआरी *ruāri*, 1075.
 रुआह *ruāh*, 1422.
 रुआह काहब *ruāh kārhāb*, 1422.
 रुकन *rukn*, 1465.

रुकन *rukan*, 1465.
रुका *rukka*, 1367.
रुक्सती *rukhsati*, 1389.
रुखान *rukhan*, 394, 399.
रुखानी *rukhani*, 399.
रुद्राक्ष *rudrākh*, 755, 781.
रुन्नी *runni*, 799, 800.
रुपाधौ *rupādhai*, 1133.
रुपै *rupai*, 1479.
रुपैया *rupaiya*, 1475, 1478, 1479, 1485.
रुपै सैकड़ा *rupai saikra*, 1479.
रुपौठी *rupauthi*, 768.
रुली *rulli*, 799.
रू *rū*, 33.
रूखा *rūa*, 1017.
रूँ *rū*, 333, 511.
रूना *rūna*, 801.
रूपधर *rūpdhar*, 1133.
रूपधर *rūpdhaur*, 1133.
रूपधौर *rūpadhaur*, 1113.
रैचाप्रत *reāet*, 1217.
रैकाना *rekāna*, 1465.
रैकाबी *rekābi*, 713.
रैगनी *regni*, 649.
रैगनी *rengni*, 1075.
रैङ्गवारी *renraṅgāri*, 1045.
रैवन्टी *rewti*, 267.
रैवन्डा *reṅura*, 1005.
रैवन्ती *reoti*, 1082.
रैहन्डा *rehra*, 816.
रैहन *rehan*, 1481.
रैहाड़ *rehār*, 816.
रैहाह *rehāh*, 816.
रै *re*, 740, 1086.
रैँ *reūr*, 957, 1045.
रैँ गैल *reūr gail*, 957.
रैँल *renral*, 957.
रैँल बा *renral ba*, 957.
रैँरा *renra*, 956, 957, 987.

रैँरा भैल बा *renra bhail ba*, 957.
रैँरा भैल है *renra bhel hai*, 987.
रैँरी *renri*, 1045.
रैत *ret*, 388.
रैती *reti*, 403, 418, 470, 471, 552, 560, 583, 591.
रैवन्टी *rewti*, 260.
रैह *reh*, 816, 1006.
रैँची *rainchi*, 1045.
रैँन *rain*, 269.
रैँनि *raini*, 1087, 1091.
रैँयत *raiyat*, 1215.
रैँयती *raiyati*, 1040.
रैँयान *raiyān*, 1217, 1226.
रैँहड़ *raihar*, 994.
रौकरिया *rokariya*, 1484.
रौकसत *roksat*, 1339.
रौकसत करब *roksat karab*, 1339.
रौकसति *roksati*, 1339.
रौकसती *roksati*, 1291, 1294.
रौकसद्दी *roksaddi*, 1291.
रौजन्नामन्चा *rojnāmcha*, 1463a and 1464.
रौजन्नामन्चा बही *rojnāmcha ba* 1463c.
रौजन्बन्धी *rojbandhi*, 1185.
रौजन्हा *rojha*, 1184.
रौजीना *rojina*, 1185.
रौपनिहार *ropnihār*, 864.
रौपबा *ropba*, 1088, 1091.
रौपन्हा *ropha*, 964.
रौरन्हा *rorha*, 786.
रौरियाह *roriyāh*, 786.
रौसकति करि देब *roskati kari deb*, 13
रौसकती *roskati*, 1291.
रौहन्नी *rohni*, 1082.
रौहिनी *rohini*, 1082, 1084.
रौक *rok*, 1488.
रौकड़ *rokar*, 1463b.
रौकड़ बही *rokar bahi*, 1463b.

रोकड़ बाकी *rokar bāki*, 1463b.
 रोकब *rokab*, 871.
 रोग *rog*, 1173.
 रोगन *rogan*, 509.
 रोज *roj*, 1185.
 रोटी *roti*, 994, 1029, 1272.
 रोटीवाला *rotiwāla*, 445.
 रोड़ा *rora*, 269.
 रोदा *roda*, 335d.
 रोप *rop*, 964, 1008.
 रोपब *ropab*, 864.

॥ ल / ॥

लई *lai*, 480.
 लईन *lain*, 1266.
 लकठो *laktho*, 1272.
 लकड़ड़ी *lakri*, 35.
 लखनवाला सञ्जाफ *lakhnawāla san-jāph*, 748.
 लखनौवाला सञ्जाफ *lakhnauāl sanjāph*, 748.
 लखनरॉव *lakhrānc*, 814.
 लखौरी *lakhauri*, 1263.
 लँगड़ा *langra*, 301, 758, 1456.
 लगन *lagan*, 711, 1289, 1344.
 लगन पत्नी *lagan patri*, 1344.
 लगना *lagnā*, 7.
 लगनपॉचे *lagnānche*, 1445.
 लँगरा *langra*, 274.
 लगवान *lagnān*, 1157.
 लगनहर *laghar*, 1157.
 लगार *lagāi*, 1319, 1336.
 लगाएब *lagāeb*, 857, 1098, 1157, 1337, 1351, 1435.
 लगा के *lagā ke*, 69.
 लगान *lagān*, 1220.
 लगानी *lagāni*, 1479.
 बगाम *lagām*, 226.
 लगामी *lagāmi*, 96.
 लगर *lagar*, 26.

रोपड *ropahu*, 1088.
 रोपा *ropa*, 964.
 रोमे *rope*, 1088.
 रोरर *rora*, 269, 1037, 1266.
 रोल *rol*, 35, 424, 1207.
 रौंजी *raunji*, 815.
 रौड़ी *rauri*, 1499.
 रौंदा *raunda*, 1005.
 रौन *raun*, 260.
 रौना *rauna*, 115, 376.
 रौल *raul*, 424.
 लगावन *lagāwan*, 1119.
 लगावन्री *lagāvuri*, 30.
 लगावस *lagāvas*, 1084.
 लगावे *lagāve*, 1084.
 लगी *lagi*, 1087.
 लयुचा *lagua*, 842, 844.
 लयुचा जन *lagua jan*, 842.
 लगूसी *lagūsi*, 41.
 लँगोटा *langota*, 726.
 लँगोटी *langoti*, 726.
 लगौरी *lagauri*, 71, 128.
 लगगा *lagga*, 40, 237, 1491.
 लगित *laggit*, 1468a and b, 1470, 1471; Appendix, 4, 10.
 लघुरी *laghuri*, 41, 237, 1491, 1492, 1496.
 लग्गी *laggi*, 768.
 लङ्गड़ *langar*, 748.
 लङ्गर *langar*, 239.
 लङ्गोट *langot*, 726.
 लखनी *lakhni*, 363.
 लखमिनिया, *lakhminiya*, 1074.
 लखुरी *lakhuri*, 652.
 लट *lat*, 1400.
 लटक *latak*, 473.
 लटधोषाद *latdhoāi*, 1400.
 लटल *latal*, 1094.

- लटग्वा *latwa*, 353, 501.
 लटाँद *latāin*, 498.
 लट्टा *latta*, 1272.
 लट्टू *lattu*, 538.
 लट्ठा *lattha*, 928, 1491.
 लठ *lath*, 653.
 लठङ्गर *lathangar*, 1323.
 लठवाही *lathwāhi*, 915.
 लठाबन्दी *lathābandi*, 1028.
 लठौंगर *lathauingar*, 1323.
 लड्डू *laddu*, 1272, 1358.
 लङ्घिया *larhiya*, 147, 201.
 लडुआ *larua*, 1272.
 लण्डा *landha*, 1109.
 लत *lat*, 1183.
 लतखोरा *latkhora*, 225, 341, 1250.
 लतमरग्वा *latmarwa*, 1250.
 लतमरा *lutmara*, 614, 939, 950, 1250.
 लतगी *latri*, 735, 999.
 लतन्हा *latha*, 1098.
 लतार *latār*, 1058.
 लतियौलें *latiyaulēn*, 1217.
 लतिहानी *lutihāni*, 807.
 लतेडा *latera*, 225.
 लता *latta*, 723.
 लती *latti*, 353.
 लथराह *lathrāh*, 1117.
 लथेर *luther*, 896, 983, 1145.
 लदग्ना *ladna*, 882.
 लदग्हा *ladha*, 17.
 लदाव *ladāv*, 224.
 लदौरी *ladauri*, 128.
 लद्दी *luddi*, 916, 954.
 लधी *ladhi*, 17.
 लपग्टा *lapta*, 1183.
 लपग्सी *lapsi*, 1272.
 लपेटन *lapetan*, 363.
 लप्पा *lappa*, 184, 119.
 लप्पू *lappu*, 184, 191.
 लप्पो *lappo*, 622.
 लब गडुहली *lab gachhuli*, 814.
 लबग्दा *labda*, 654.
 लबग्ना *labna*, 713.
 लबग्नी *labni*, 376, 713.
 लबय *labay*, 1084.
 लबेर *laber*, 419.
 लबेरी *laberi*, 419.
 लमग्का *lamka*, 1059.
 लमग्का चलुआ *lamka alua*, 1059.
 लमग्ती *lami*, 828.
 लमग्दर *lamurdār*, 1208.
 लमेरा *lamera*, 861, 980.
 लम्बरग्दर *lambardār*, 1208.
 लम्भब *lambhab*, 1132.
 लम्हेर *lamher*, 861.
 लर *lar*, 595.
 लरग्कटिया *larkatiya*, 985.
 लरग्का *larka*, 1074.
 लरग्किनी *larkini*, 1282.
 लरग्हा *larchha*, 1048.
 लरग्जौका *larjonka*, 1183.
 लरत *larat*, 585.
 लरत देब *larat deb*, 585.
 लरग्ना *larna*, 56, 346, 439, 508, 57
 लरग्नी *larni*, 17, 817.
 लरम *laram*, 786.
 लरग्मा *larma*, 1016.
 लरग्खो *larlo*, 270.
 लरग्वाहा *larwāha*, 915.
 लरग्हा *larha*, 40.
 लरग्ही *larhi*, 996, 1183, 1257.
 लरग्खो *larho*, 996.
 लरिका *larika*, 1281, 1286, 1401.
 लरिका खोज *larika khaj*, 1286.
 लरिका लोकाग्रब *larika lokāeb*, 140.
 लरिक्की *lariki*, 1282.
 लरी *lari*, 363.
 लरवा *larua*, 195, 990.
 लरेठा *laretha*, 896.

लरेठो *laretho*, 994.
 ललन्का *lalka*, 956, 1057, 1059.
 ललन्की *lalki*, 786.
 ललन्की मिट्टी *lalki mitti*, 786.
 ललग्गोंदिया *laggonidiya*, 968.
 ललग्गोंड़ी *lalgouri*, 1005.
 ललन्देदया *lalndēya*, 967, 972.
 ललन्री *lalri*, 765.
 ललन्घात वा *lalthāt ba*, 987.
 लवन्ठा *lawtha*, 2, 825.
 लवन्ठा के जोत *lawtha ke jot*, 825.
 लसम *lasam*, 480.
 लसन्गा *lanhga*, 743.
 लसन्ठी *lahthi*, 571.
 लसन्ना *lahna*, 1477.
 लसन्नाप्रल *lahnāēl*, 1079.
 लसन्वेटा *lahbeta*, 1279.
 लहर *lahar*, 1173.
 लहरन्नी *laharni*, 383, 1030.
 लहरैठा *lahraitha*, 994.
 लहलहा *lahlaha*, 987.
 लहलहा रहल है *lahlaha rahal hai*,
 987.
 लहन्वाइ *lahncāi*, 303.
 लहन्सुन *lahsun*, 1073.
 लहन्सुर *lahsur*, 574.
 लहास *lahās*, 115.
 लहासी *lahāsi*, 115, 239.
 लहुरी *lahuri*, 1276.
 लहेरिया *laheriya*, 533.
 लहेरा *lahera*, 570.
 लहेरी *laheri*, 570.
 लहाँगा *lahauंगा*, 480.
 लहौरी *lahauri*, 1263.
 ला *la*, 444, 572, 1272, 1419.
 लाइ *lai*, 1272.
 लाइव *läith*, 346.
 लाइलि *läili*, 740.
 लाउर *laur*, 653.
 लाप्रद् *läed*, 92.

लाप्रब *läeb*, 25, 1478.
 लाख *läkh*, 570.
 लाखन्राख *läkhrāj*, 1209h.
 लाग *läg*, 1445.
 लागत वा *lägat ba*, 1001.
 लागन *lägan*, 7.
 लागनि *lägani*, 331.
 लाग पञ्चमी *läy panchami*, 1445.
 लागल *lägal*, 1001, 1004, 1437.
 लाँगल *längal*, 1.
 लागा *läga*, 1383.
 लागी *lägi*, 1482.
 लागे *läge*, 1026.
 लाँजी *länji*, 965k.
 लागौ *lägau*, 45.
 लाट *lät*, 1207.
 लाटा *läta*, 1272.
 लाठ *läth*, 273, 346, 414, 431, 917,
 928, 931.
 लाठा *lätha*, 116, 414, 928, 931.
 लाठी *läthi*, 362, 390, 653, 655,
 833, 1085.
 लाठीन्डोर *läthidor*, 362.
 लाइनि *lävani*, 439.
 लाँदा *lävrha*, 1109.
 लाद *läd*, 92, 713.
 लाध *lädh*, 258, 276.
 लाधा *lädha*, 17.
 लाबर *läbar*, 419.
 लाभ *läbh*, 900, 1483.
 लाँभ *lämbhab*, 1132.
 लाभसभ *läbh sābh*, 1483.
 लाभ *läm*, 861.
 लान्भ *lämhāb*, 1132.
 लार *läar*, 75, 60, 90, 880, 894, 963,
 990, 1183, 1259.
 लारन *läran*, 17.
 लारनि *lärani*, 346.
 लारी *läri*, 529, 570.
 लारु *läru*, 60.

लाल *lāl*, 585, 975, 1135, 1138,
 1306, 1499.
 लाल केशर *lāl kesar*, 975.
 लाल देह्या *lāldēhya*, 972.
 लाल बगन्हाला *lāl baghalla*, 1138.
 लाल माटी *lāl māti*, 1306.
 लालन्मी *lālmi*, 1065.
 लाला *lāla*, 585.
 लावन *lāvan*, 1477.
 लावन भावन *lāvan bhāvan*, 1477.
 लावा *lāva*, 433, 1272, 1339, 1332,
 1445, 1483.
 लावा घोली *lāva gholi*, 1483.
 लावा छिटाइ *lāva chhitāi*, 1309, 1332.
 लावा दूआ *lāva dūa*, 1483.
 लावा मिराइब *lāva mirāib*, 1332.
 लासा *lāsa*, 381.
 लाह *lāh*, 570, 713.
 लाहखर *lākhhar*, 482.
 लाहाउरी *lāhāuri*, 1263.
 लाही *lāhi*, 1045, 1074.
 लाखावन *lāxāvan*, 1292.
 लिख *likh*, 655.
 लिख गहन्नी *likh gahni*, 747.
 लिभन्ही *lijhri*, 1401.
 लिट्टी *litti*, 466, 994, 1272.
 लिही *lihi*, 848.
 लिपाइ *lipāi*, 1402, 1413.
 लिये *liye*, 655.
 लिहाइ *lihāi*, 408, 526.
 लिहावर *liharar*, 397.
 लीद *lid*, 848.
 लीदी *lidi*, 848.
 लील *li*, 1038, 1040.
 लीला *li*, 1043.
 लीला डोम *li* *dom*, 1456.
 लीलू *li*, 585(f).
 लुकन्वारी *lukvāri*, 1448.
 लुकान *lukān*, 957.
 लुकारी *lukāri*, 1448.

लुकुम *lukum*, 1268.
 लुखरी *lukhri*, 1091.
 लुगन्रिये *lugriye*, 740.
 लुगरी *lugri*, 740.
 लुग्या *lugga*, 723.
 लुङ्गी *lungi*, 383, 726, 733, 1430.
 लुष्ठा *lunda*, 710.
 लुचुई *luchui*, 1272.
 लुतिया *lutiya*, 1073.
 लुपन्धी *luplhi*, 977.
 लुरन्का *lurka*, 1074.
 लूकाहि *lūkahī*, 1087.
 लुका *lūka*, 1419.
 लुगा *lūga*, 723, 740.
 लुंगी *lūngi*, 733, 1430.
 लुंड़ा *lūra*, 121, 710.
 लुंडई *lūrai*, 1075, 1183.
 लुङ्ग्वारी *lūgvāri*, 1045.
 लुंडुड़ी *lūmuri*, 984.
 लुडियाग्रल *lūdhīyāḷ*, 1153.
 लुताहर *lūthar*, 1292.
 लुदरा *ludra*, 731.
 लुंदरा *lundra*, 637, 731.
 लुंदाल *lūdāl*, 1267.
 लुयारी *luyāri*, 1292.
 लुवचा *lueva*, 990.
 लुवनिहार *lūvnihār*, 874.
 लुवार *lūvār*, 376.
 लुवारा *lūvāra*, 151.
 लुहन्डिवाला *lūhricāla*, 1156.
 लुहन्ना *lūhua*, 1144.
 लुहन्नी *lūhni*, 512, 555, 557, 880.
 लुहन्सुर *lūhsur*, 574.
 लुहाइ *lehāi*, 408.
 लुहाप्र *lehāp*, 549.
 लुहाफ *lehāph*, 731.
 लुहाली *lehāli*, 731.
 लुहोंगा *lehonga*, 480.
 ले *le*, 572, 919, 1025, 1084, 1416.
 लेइ *lei*, 423, 480.

लेखा *lekha*, 1463c.
 लेखा बची *lekha bahi*, 1463c.
 ले जाग्रब *le jāēb*, 919.
 लेंद *lenr*, 1045.
 लेंही *lenri*, 848.
 लेंह *lenrh*, 1153.
 लेंहा *lenrha*, 984, 1074.
 लेन *let*, 568.
 लेद *led*, 932.
 लेदा *leda*, 932.
 लेदी *ledi*, 932.
 लेध *ledh*, 932.
 लेधऱ *ledha*, 258.
 लेधा *ledha*, 17, 276.
 लेधो *ledho*, 932.
 लेन *len*, 1461
 लेन देन *len den*, 1461.
 लेने *lenē*, 3.
 लेने खाब *lenē āw*, 3.
 लेब *leb*, 915, 1394, 1419, 1129, 1135,
 1478, 1484, 1485.
 लेह *levu*, 1118.
 लेहो *lehō*, 1217.
 लेब *leo*, 709, 824, 915, 981.
 लेब करब *leo karab*, 981.
 लेवत *levat*, 645.
 लेवन *levan*, 709.
 लेवा *leva*, 126, 233, 637, 709, 824,
 858, 915, 1032, 1259.
 लेवा खान्ही *leva khānhi*, 1259.
 लेभो *leso*, 1054, 1055.
 लेहड़ *lēhār*, 1124.
 लेहन *lehan*, 880.
 लेहला *lehala*, 904.
 लेही *lei*, 604, 763, 1451.
 लेधा *lēdha*, 17.
 लेन *lein*, 1160.
 लेनू *lainu*, 1161, 1166.
 लोकनाहा *loknāha*, 1293.
 लोकनिया *lokanīya*, 1293.

लोकनी *lokani*, 1293.
 लोकाग्रब *lokāēb*, 1401.
 लोकाना *lokāna*, 1140, 1141.
 लोंगचुरा *longchūra*, 973.
 लोंगिया मरिचा *longiya maricha*, 1073.
 लोंगिया मिरिच *longiya mirich*, 1073.
 लोचनी *lochni*, 363.
 लोटकी *lotki*, 690.
 लोटली *lotli*, 1339.
 लोड़ियारो *loriyaro*, 1154.
 लोन्ताहार *lorhtāhar*, 878.
 लोहनिहार *lorhnihār*, 878, 1017.
 लोहिया *lorhiya*, 878.
 लोभबश्चा *lobhera*, 769.
 लोरकाइ *lorkāi*, 1154.
 लोरिका *lorika*, 1154.
 लोहड़ा *lohara*, 480.
 लोहड़, *lohara*, 929.
 लोहरा *lohra*, 878, 967j.
 लोहरा *lohra*, 695.
 लोहरी *lohari*, 695.
 लोहलड़र *lohlangar*, 239.
 लोहमारी *lohmarī*, 107.
 लोनामा *lohāma*, 10.
 लहार *lahār*, 407, 538, 1191, 1204.
 लोहिया *lohīya*, 466, 480, 673, 695.
 लोइया *loiya*, 1251, 1272.
 लोहर *lohar*, 383, 482, 734.
 लोम *lom*, 1217, 1275.
 लोहर *lohār*, 1129.
 लोह *loh*, 1052.
 लोटा *lota*, 115, 687, 711.
 लोटी *loti*, 1052.
 लोड़ा *lohra*, 1266.
 लोह *loh*, 421.
 लोहन *lohana*, 899.
 लोहा *lohā*, 627, 878, 911, 1317.
 लोहा बिबा *lohā biēbā*, 878.
 लोही *lohi*, 627, 748, 878.

लौंदा *londu*, 466, 1251.
 लौंदी *lonđi*, 1251.
 लोथा *lotha*, 318.
 लोपन *lopan*, 551, 705.
 लोर *lor*, 753, 764.
 लोह *loh*, 414.
 लौंगरा *laungra*, 758.
 लौगाही *laugāchhi*, 814.
 लौकुचा *lachhua*, 1326,

लौताहर *lautāhar*, 1292.
 लौथा *laua*, 1068.
 लौका *lauka*, 1068.
 लौकी *lauki*, 585.
 लौंग *laung*, 763.
 लौठा *lautha*, 377.
 लौनी *launi*, 873.
 लौनी करल *launi karal*, 873.
 लौर *laur*, 653.

॥ व w ॥

वजू *vaju*, 1430.
 वजू कराएब *vaju karāēb*, 1430.
 वफा *vapha*, 1482
 वादा *wāda*, 1367.
 वादा का बक्का *wāda ka rukka*, 1367.

वारजा *wārja*, 1470, 1471.
 वाला *wāla*, 502, 832, 889, 1001
 1267.
 वासिल *wāsil*, 1468a, 1472.
 वासिल बाकी *wāsil bāki*, 1468a, 1472.

॥ श sh ॥

शयुन *shagun*, 1454.
 शरई *sharāi*, 1361, 1362.
 शलुका *shaluka*, 729.
 शादी *shādi*, 1273.
 शाम *shām*, 1183.
 शाम तुलसी *shām tulsi*, 1183.

शाहाना *shāhāna*, 1381.
 शिकमी *shikmi*, 1225, 1226.
 शतुर *shatur*, 1131.
 शमङ्गली *shumangali*, 1273, 1328.
 शोई *shoi*, 1369.
 शौहर *shauhar*, 1274.

॥ स s ॥

सँ *sañ*, 1113.
 सईल *saił*, 938.
 सकरई *sakrai*, 1474.
 सकरकन्द *sakarukand*, 1059.
 सकरचौनी *sakarachāni*, 1005.
 सकरपाळा *sakarpāla*, 1272.
 सकारब *sakārab*, 1487.
 सक्कर *sakkar*, 318, 1014, 1089.
 सखारी *sakhāri*, 657.
 सगन्दिना *sagpahita*, 1272.

सगरदिना *sagardina*, 837.
 सगरा *sagra*, 1091.
 सँगरा *sangra*, 922.
 सगहम *sagaham*, 1279.
 सगळ्या *saguhua*, 1279.
 सँगळ्या *sañghua*, 1279.
 सगार *sagāi*, 1279.
 सँगहा *sangāha*, 1201.
 सँगिया *sangiya*, 73.
 सयुन *sayun*, 1454.

- सगुनी *saguni*, 177, 193.
 सगून *sagūn*, 177, 178, 179, 184,
 190, 191, 193, 195, 200, 204.
 सगार *saggar*, 147, 201, 203, 204.
 सङ्कर *sankar*, 771, 1014.
 सङ्कल्प *sankalp*, 1209a.
 सङ्क *sankh*, 776.
 सङ्ग *sang*, 655, 990, 1184.
 सजग्वा *sajwa*, 1163.
 सँजगहरिया *sanjhariya*, 837.
 सजाव *sajao*, 1163.
 सजाव दही *sajao dahi*, 1163.
 सजिवन *sajivan*, 1068.
 सजुद *sajui*, 1162.
 सजोखा *sajca*, 636.
 सजोर *sajor*, 858.
 सज्जा *sajjha*, 846.
 सझिया *sajhiya*, 291.
 सँझिया *sanjhiya*, 837.
 सझियैती *sajhyaiti*, 291.
 सँझीखा *sanjhaua*, 1270.
 सञ्चा *sancha*, 576, 984.
 सञ्जाफ *sanjāph*, 748.
 सटक *satak*, 473.
 सटन्का *satkā*, 99, 653.
 सटिया *satiya*, 762.
 सटौखा *sataua*, 1482.
 सटौखा पटौखा *sataua patana*, 1482.
 सठोरा *sathora*, 1399.
 सङ्का *sarka*, 1074.
 सँङ्सी *sanrsi*, 404, 411, 511, 515,
 539, 546, 557, 560, 552, 704.
 सँङ्गारी *sanrāri*, 330.
 सँङ्गवा *sanrusa*, 32.
 सङ्गे *sarc*, 1087.
 सङ्गी *saddhi*, Appendix, 2a.
 सण्ठी *santhi*, 896, 1048.
 सत *sat*, 12, 1332.
 सतन्धरन्वा *satgharwa*, 442.
 सतन्धर *satattur*, 1118.
 सतन्दन्ता *satdanta*, 1118.
 सतन्दर *satdar*, 1118.
 सत धरिया *sat dhariya*, 12.
 सतन्नराष्ट्र *satnahāēb*, 1424.
 सतन्पुतिया *satputiya*, 1069.
 सतन्भीखा *satbhikha*, 1082.
 सत भौरी *sat bhauri*, 1332.
 सतन्मसुखा *satmasua*, 1396.
 सतन्मास *satmās*, 1396.
 सतन्रञ्जी *satranji*, 750.
 सतरिया *safariya*, 965l.
 सतन्लरी *sālari*, 765.
 सतन्वनिथाँ *satvaniyān*, 238.
 सतन्वाँस *satwāns*, 1396.
 सतन्वाँसा *satwānsa*, 1396.
 सतन्वाँसू *satwānsu*, 1396.
 सती *sati*, 1456.
 सतुखा *satua*, 1272.
 सतुखाइन *satuaīn*, 1449.
 सतुखानी *satuañi*, 1449.
 सतुर *satui*, 1272.
 सत्तर *ṣattar*, 1118.
 सत्ती *satti*, 572.
 सतू *sattu*, 1272, 1443, 1449.
 सथन्धर *sathdhar*, 1118.
 सदर *sadar*, 1219.
 सदर दरन्वाजा *sadar darwāja*, 1249.
 सदरी *saduri*, 729.
 सदा *saha*, 655.
 सदियात *sadiyāt*, 1201.
 सदियाना *sadiyāna*, 1201.
 सँदुकन्ची *sandukrchi*, 656.
 सधन्वा *sadhwa*, 1277.
 सधोर *sadhur*, 1399.
 सधौखा *sadhaua*, 1210, 1482.
 सधौखा पटौखा *sadhaua patana*, 1210,
 1482.
 सन *san*, 29, 165, 886n, 984, 1047,
 1089.
 सनई *sanaī*, 1048.

समङ्की *sanki*, 713.
 सन्धीष्ठा *sandhoa*, 542.
 सन्सनाठी *sansanāthi*, 1048.
 सन्सा *sansa*, 546, 557.
 सन्सी *sansi*, 552, 554.
 सन्सोगिला *sansogila*, 661.
 सन्सक *sanhak*, 713.
 सन्सकी *sanhaki*, 713.
 सना *sana*, 1272.
 सनाठी *sanāthi*, 1048.
 सनिचन्ना *sanichra*, 1456.
 सनीचर *sanīchar*, 1088.
 सनुकची *sanukchi*, 656.
 सनुख *sanukh*, 656.
 सनुक *sanūk*, 656.
 सनेस *sanes*, 1347.
 सनै *sanaī*, 1048.
 सनैठा *sanaitha*, 1048.
 सनौटा *sanauta*, 685.
 सन्दुख *sandukh*, 656.
 सन्दुक *sandūk*, 656.
 सन्देह *sandeh*, 1272.
 सन्यासी *ṣanyāsi*, 1203, 1429.
 सपई *sapāi*, 309.
 सपट *sapat*, 860.
 सपट जादल *sapat jāil*, 860.
 सपण्टा *sapta*, 860
 सपण्टा जादल *sapta jāil*, 860.
 सपण्णाइ *sapṇāi*, 1234.
 सपरी *sapri*, 662.
 सपुरा *sapura*, 1050.
 सप्तमी *saptami*, 1087.
 सफ *saph*, 751.
 सफई *saphāi*, 305.
 सफगोल *saphgol*, 1073.
 सफाइ *saphāi*, 1485.
 सफेद *saphed*, 976.
 सफैया *saphaiya*, 305.
 सबन्जा *sabja*, 1036.
 सबन्जी *sabji*, 996.

| सवठैती *sabthaiti*, 291.
 सबन्ना *sabra*, 513, 549.
 सबन्नी *sabri*, 513, 549.
 सबुजा *sabuja*, 1043.
 सबुजी *sabuji*, 1036.
 सभ *sabh*, 12, 1026, 1085, 1089.
 सभन्धर *sabhdhar*, 12.
 सभ धरिया *sabh dhariya*, 12.
 समन्दान *samdān*, 524, 549.
 समध *samadh*, 1279.
 समधिन *samdhin*, 1302.
 समन्धी *samdhi*, 1302, 1339.
 समधी मिलावा *samdhi milāwa*, 1339
 समन्धो *samdho*, 1339.
 समन *saman*, 1210.
 समन्सान *samsān*, 1418.
 समन्सेबन्द *samseband*, 768.
 समन्सेर *samser*, 502.
 समन्सेरक *samserak*, 502.
 समन्कत *samhut*, 839, 877, 143
 1439.
 समना *sama*, 989.
 समाचारी *samāchāri*, 1487.
 समाचारी चिड्डी *samāchāri chitti*
 1457.
 समाठ *samāth*, 431, 464, 610, 617.
 समँठ *samānth*, 610.
 समाध *samādhi*, 1429.
 समाध मँ बैसाग्रब *samādhi men baisār*
 1429.
 समाधि *samādhi*, 1429.
 समाधि (or समाध) लेब *samādhi (*
samadh) leb, 1429.
 समार *samār*, 819, 826, 828, 857.
 समाली *samāli*, 726.
 समाह *samāh*, 826.
 समियाँ *samiyāñ*, 618.
 समुख *samukh*, 1249.
 समुख दरोजा *samukh duroja*, 1249.
 समेल *samel*, 18.

- समैया *samaiya*, 16.
 समैल *samail*, 15, 16, 191, 18, 938.
 समैला *samaila*, 16, 938.
 समोषा *samosa*, 1272.
 समौषा *samausa*, 610, 618.
 समौध *samaudh*, 818, 839.
 सम्बन्ध *sambandh*, 1279.
 सम्मान *samman*, 568.
 सम्मल *sammal*, 194.
 सर *sar*, 358, 949.
 सरई *sarai*, 1051.
 सरक *sarak*, 1174.
 सरक जाग्रव *sarak jācb*, 1174.
 सरकण्डा *sarkanda*, 1051.
 सरकण्डी *sarkandi*, 565.
 सरका *sarka*, 358.
 सरकार *sarkār*, 1208.
 सरकौनी *sarkauui*, 363.
 सरकौनी के खूँटी *sarkauui ke khunti*,
 363.
 सरखत *sarkhat*, 1464.
 सरग *sarag*, 105, 1101, 1113.
 सरगन्पताली *saragpatāli*, 1101, 1113.
 सरगाँ *sargān*, 494.
 सरङ्गन्पताली *sarangpatāli*, 1101.
 सरङ्गा *saranga*, 230.
 सरन्दर *sardar*, 1028, 1257.
 सरन्दर परन्तर *sardar partar*, 1028.
 सरन्दार *sardār*, 1450, 1452.
 सरन्पच *sarpanch*, 1450.
 सरन्पत *sarpat*, 120.
 सरन्पोस *sarpos*, 700, 711.
 सरन्वत *sarbat*, 1015, 1272.
 सरन्वी *sarbi*, 713.
 सरन्रा *sarra*, 940.
 सरन्वा *sarwa*, 438.
 सरन्सी *sarsi*, 511.
 सरन्सौँ *sarson*, 1045.
 सरह *sarah*, 1220.
 सरहन्ची *sarhanchi*, 1183.
 सरहज *sarhaj*, 1386.
 सरहथ *sarhuth*, 55.
 सरहबन्दी *sarabandi*, 1220.
 सरहिया *sarahiya*, 438.
 सराइ *sarāi*, 551, 705, 775.
 सराफ *sarāph*, 1461.
 सरासर *sarāsar*, 475.
 सरिकन्दार *sarikdār*, 1214.
 सरिन्ना *sarinna*, 230.
 सरिया *sariya*, 740.
 सरिया के *sariyā ke*, 817.
 सरिया के जोतल *sariyā ke jotal*, 817.
 सरिया के धरल *sariyā ke dharal*, 817.
 सरिसो *sariso*, 896, 1045.
 सरिसौँ *sarisoni*, 1045.
 सरिहन *sarihan*, 969, 972.
 सरि *sari*, 972.
 सरै *sare*, 1220.
 सरैस *sares*, 404.
 सरैस कन्ना *sares kannu*, 404.
 सरैस कागज *sares kāgaj*, 404.
 सरैस पत्ता *sares patta*, 404.
 सरैह *sarch*, 784b.
 सरैला *saraila*, 48.
 सरौँची *saraunchi*, 1183.
 सरौता *saranta*, 1056.
 सलखो *salkho*, 1456.
 सलन्गम *salgam*, 1073.
 सलन्गा *salga*, 730.
 सलन्जम *saljam*, 1073.
 सलन्वात *salwāt*, 1408.
 सलाई *salāi*, 221, 386, 499, 539,
 546.
 सलाग *salāg*, 566.
 सलाम *salām*, 1393.
 सलामी *salāmi*, 1201, 1205, 1347,
 1474.
 सलीना *salina*, 230, 1185.
 सलेस *sales*, 592, 1456.
 सलैया *salaiya*, 221.

- सल्हेस *salthes*, 1455, 1456.
 सल्हेस अस्थान, *salthes asthān*, 1455.
 सवार *savāi*, 1092, 1475, 1479.
 सवार डेही *savāi dēhi*, 1475.
 सवामी *savāmi*, 1274.
 सवार *savār*, 235.
 सवारी *savāri*, 1275.
 सवासिन *savāsīn*, 1277.
 सवेया *savaiya*, 1203, 1479, 1500.
 ससुरा *sasura*, 1296.
 ससुरार *sasurār*, 1296, 1300.
 ससुराल *sasurāl*, 1296.
 ससुरैतिन *sasuraitin*, 1277.
 संस्कार *sanskār*, 1416.
 संस्कार देब *sanskār deb*, 1416.
 सहज *sahjan*, 1073, 1183.
 सहजना *sahjana*, 1073.
 सहजादी मार *sahjādi māi*, 1456.
 सहजा मार *sahja māi*, 1456.
 सहजतौर *sahjātir*, 322.
 सहदेरया *sahdēiya*, 966c.
 सहन *sahan*, 235.
 सहनक *sahnak*, 1377.
 सहरी *sahri*, 887.
 सहरोस *sahras*, 1117.
 सहल *sahal*, 414.
 सहसर *sahasar*, 604.
 सहार *sahār*, 1203.
 सहिजन *sāhijān*, 1073.
 सही *sahi*, 990.
 सहेर *saher*, 1124.
 साँई *sāñīñ*, 1183, 1274.
 साउत *saut*, 1276.
 साप्रवान *sāēbān*, 1242, 1430.
 साखोंख *sāonkh*, 842.
 साखोन *sāon*, 1082, 1087, 1088.
 साँखोर *sāñor*, 1113.
 साक *sāk*, 1486.
 साक उखड़ गेलैन्हि *sāk ukhar gelainhi*,
 1486.
 साँखा *sānkhā*, 538.
 साग *sāg*, 1001, 1073.
 साँगा *sānga*, 3, 1255.
 सागड़ *sāgar*, 147, 201.
 सागर *sāgar*, 782.
 साँगा *sāngah*, 3, 1255.
 साँघुत *sāñghut*, 1279.
 साचक *sāchak*, 1381.
 साँचा *sānchā*, 419, 557, 560, 565,
 570, 576, 600.
 साँची *sānchī*, 726, 1049, 1163.
 साज *sāj*, 1371.
 साजन *sājan*, 372.
 साज बेचोतब *sāj beotab*, 1371.
 साजी *sāji*, 45.
 साँझ *sāñjh*, 226.
 साँझ ले *sāñjh le*, 837.
 साटा *sātā*, 99.
 साँटा *sāntā*, 99.
 साटी *sāti*, 477, 843, 1155.
 साटी पाटी *sāti pāti*, 843.
 साठ *sāth*, 965, 966.
 साठी *sāthi*, 965, 966f, 1085, 1089
 साड़ी *sāri*, 740.
 साँढ़ *sāñrh*, 5, 1095, 1112.
 सादा *sāda*, 468, 585f, 1023, 1250.
 सादा चादर *sādu chādar*, 585f.
 सादियात *sādiyāt*, 1201.
 सादी *sādi*, 1273.
 साध *sādhi*, 1484.
 साधब *sādhab*, 1484.
 साधा लेब *sādhi leb*, 1484.
 साधनी *sādhiñi*, 426.
 साधू *sādhu*, 782.
 सान *sān*, 538, 539, 1025, 1086.
 सानि *sāni*, 1272.
 सानी *sāni*, 1144, 1145, 1279.
 सानी पानी *sāni pāni*, 1145.
 सानी पानी करब (or देब) *sāni pā.
 karab (or deb)*, 1145.

- सापट *sāpat*, 847.
 साँपुर *sāmpur*, 1050.
 साफू *sāph*, 1485.
 साफी *sāphi*, 401, 404, 733, 1430.
 साफी रन्दा *sāphi randa*, 401.
 साबर *sābar*, 549, 1139.
 साबल *sābal*, 513.
 साबुन *sabun*, 393, 740.
 साभ *sābh*, 1483.
 साम *sām*, 60, 221, 618, 975.
 साम जीरा *sām jira*, 975, 979.
 सामा *sāma*, 221, 989, 1183.
 साँमा *sāmma*, 221.
 सामी *sāmi*, 60, 221, 249, 1088, 1183, 1274.
 सायर *sāyar*, Appendix, 16.
 सायाब्दी *sāyābandī*, 1373.
 साही *sāhi*, 1163.
 सार *sār*, 977, 978, 1087, 1153.
 साँगी *sarangi*, 276.
 सारजी *sārjī*, 748.
 सारा *sāra*, 611, 1419.
 सारि *sāri*, 1087.
 सारी *sāri*, 740, 766, 1385.
 सारू *sāru*, 1173.
 साल *sāl*, 379, 1118.
 सालक *sālak*, 414.
 सालग्राम *sālgrām*, 1451.
 सालियाना *sāliyāna*, 1185.
 सालिस *sālis*, 913.
 साली *sāli*, 1089, 1194.
 सालीना *sālina*, 1185, 1207.
 सालीना खरब *sālina kharch*, 1207.
 सालू *sālu*, 742, 1042.
 साव *sāo*, 1461.
 साँवगी *sāmgi*, 208, 212, 213, 224.
 साँवगी गाड़ी *sāmgi gāri*, 148, 208.
 सावन *sāvan*, 1082.
 साँवर *sānur*, 1134.
 सावाँ *sāwān*, 989.
 साँवाँ *sāwān*, 989, 1074, 1183.
 सालिग्राम *sāliyrām*, 1451.
 साँस *sāns*, 1272.
 सासत *sāsāt*, 495.
 साँसत *sānsāt*, 495.
 साँसर *sānsar*, 495.
 साँसी *sānsi*, 301.
 सासुर *sāsūr*, 1296.
 साह *sāh*, 1250, 1461, 1474.
 साहबगञ्ज *sāhabganj*, 1183.
 साहवाला *sāh.wāla*, 1250.
 साहिल *sāhil*, 965m, 966f.
 साही *sāhi*, 1005.
 साहकार *sāhukār*, 1461.
 साहुल *sāhul*, 425.
 साहब *sāheb*, 1456.
 सिऊठा *siūnthā*, 703.
 सिकन्हा *sikanja*, 587.
 सिकन्डा *sikra*, 793.
 सिकन्डी *sikri*, 1262.
 सिकन्डौर *sikraur*, 793.
 सिकन्दरी *sikandri*, 1491.
 सिकन्दरी गज *sikandri gaj*, 1491.
 सिकन्पटई *sikpatai*, 657.
 सिकन्मी *sikmi*, 1212, 1213, 1214, 1219, 1225.
 सिकन्रा *sikra*, 107.
 सिकन्री *sikri*, 107, 755, 762, 764, 765, 767.
 सिकस्त *sikast*, 788.
 सिकन्हर *sikhār*, 648, 651, 1422.
 सिकन्हुती *sikahuti*, 41.
 सिकार *sikār*, 1232.
 सिकार साही *sikār māhi*, 1232.
 सिकिचो *sikw*, 1087.
 सिकिलगर *sikilyar*, 602.
 सिकौती *sikauti*, 41.
 सिकड़ *sikkar*, 107.
 सिकर *sikkar*, 107.
 सिकका *sikka*, 651, 235

- सिंखचा *sinkhcha*, 711.
 सिंगजूटा *singjutta*, 1102.
 सिंगजूटल *singjūtal*, 1102.
 सिंगठा *singtha*, 480.
 सिगन्ता *sigta*, 786.
 सिंगरा *singra*, 965n.
 सिंगरा *singha*, 954.
 सिंगासन *singāsan*, 777.
 सिंगेसर *singesar*, 1456.
 सिघन्हा *singhtutta*, 1108.
 सिघाहा *singhāra*, 1073.
 सिघारा *singhāra*, 748, 1055.
 सिघासन *singhāsan*, 777.
 सिघौटा *singhauta*, 602.
 सिङ्गा *singa*, 483.
 सिङ्घ *singh*, 483, 1087.
 सिङ्घा *singha*, 784.
 सिङ्घी *singhi*, 688, 1101.
 सिंचवाहा *sinchrāha*, 915.
 सिज्कोहड़ा *sijkōhṛa*, 1071.
 सिजो *sinjo*, 489.
 सिंजोय *sinjoy*, 489.
 सिद्धी *sitthi*, 1012.
 सिंड़ाच *sindrāch*, 789.
 सिड़ाहा *sirāha*, 789.
 सिही *sirhi*, 319j.
 सिहाना *sirhāna*, 638.
 सिहानी *sirhāni*, 637, 638.
 सितलक *sittlak*, 1449.
 सितलपाटी *sitalpāti*, 751.
 सितलबुकनी *sitalbukni*, 1272.
 सितल्ला *sitla*, 765, 1449.
 सितल्ला देबी *sitla debi*, 1449.
 सितली *sitli*, 1456.
 सितारा *sitāra*, 585.
 सितो *siti*, 977.
 सितो सार *siti sār*, 977.
 सितुचा *situa*, 319, 1030, 1267.
 सितुरियापल्ल *situriyāēl*, 1076.
 सितुहा *situha*, 535, 1030, 1267, 1408.
 सिनु *sittu*, 1267.
 सिधन्वा *sidhwāi*, 195.
 सिधन्वानी *sidhwāni*, 639.
 सिधा *sidha*, 1272.
 सिधांत *sidhānt*, 1354.
 सिंधोरा *sindhora*, 662.
 सिनेह *sineh*, 1314.
 सिनेह के पानि *sineh ke pāni*, 1314.
 सिन्दुर *sindur*, 1334.
 सिन्दुर दान *sindur dān*, 1334.
 सिपन्वा *sipwa*, 195, 243, 1256.
 सिपावा *sipāwa*, 195, 260, 243.
 सिपाहा *sipāha*, 243.
 सिपाही *sipāhi*, 1449.
 सिपौचा *sipāua*, 248.
 सिब *sib*, 1429, 1455, 1456.
 सिब अन्स *sib ans*, 1203.
 सिब नारैनी *sib nārāni*, 1429.
 सिबोतर *sibotar*, 1209a.
 सिमल *simal*, 20.
 सिमल *simmal*, 194.
 सियार *siyār*, 1088.
 सियाच *siyāch*, 976, 996.
 सियाहा *siyāha* 1468a and b, 1470
 1471, 1472; Appendix, 6, 12.
 सिर्हानी *sirhāni*, 637.
 सिर *sir*, 1451.
 सिरकी *sirki*, 815, 1234.
 सिरन्नामा *sirnāma*, 1487.
 सिरनी *sirni*, 1440.
 सिरपचर *sirpachar*, 839.
 सिरपंचमी *sirpanchmi*, 839.
 सिरपाया *sirpāya*, 195.
 सिरमा *sirma*, 638.
 सिरमान *sirmān*, 871.
 सिरवा *sirwa*, 243.
 सिरवाँसी *sirwānsi*, 638.
 सिरहट्टी *sirhatti*, 967k, 969.
 सिरहण्ट *sirhant*, 966.
 सिरहत *sirhat*, 57.

- सिरहथ *sirhath*, 55.
 सिरहान *sirhān*, 638.
 सिरहाना *sirhāna*, 638.
 सिरा *sira*, 1014, 1272.
 सिरावर *sirāur*, 835, 1006.
 सिरार *sirār*, 362.
 सिरारा *sirāra*, 364.
 सिरारी *sirāri*, 362.
 सिररी *siri*, 973.
 सिररी केबल *siri kebal*, 973.
 सिरुवा *sirua*, 1272.
 सिरुका *siruka*, 1074.
 सिरोर *siror*, 835.
 सिरोरा *sirora*, 1074.
 सिरौर *siraur*, 835.
 सिल *sil*, 404.
 सिलफन्ची *silaphchi*, 699.
 सिलवट *silvat*, 626.
 सिलवे *silve*, 30.
 सिलहट *silhat*, 972.
 सिलहरा *silahra*, 749.
 सिलावट *silāwat*, 626.
 सिलेबा *sileba*, 1134.
 सिलेबे *silebe*, 1134.
 सिलौट *silaut*, 626.
 सिल्ला *silla*, 383, 487, 573.
 सिल्ली *silli*, 82, 383, 539, 892, 894,
 1265.
 सिवाती *sivāti*, 1082, 1084.
 सिष्कटन्नी *siskatni*, 875.
 सिष्कॉहन्डा *siskoāhra*, 1071.
 सिष्फुल *sishphul*, 762.
 सिसुवा *sisua*, 985.
 सिसुवा गोडमा *sisua gohuma*, 985.
 सिहरा *sihra*, 1381, 1384.
 सिहोरन्नी *sihorni*, 319e.
 सिहोडा *sihora*, 1183.
 सिहोर *sihor*, 1183.
 शीक *sik*, 648, 652.
 शीक *sīnk*, 447, 546.
 शीकर *sikar*, 33, 107, 198.
 शीकर *sīnkar*, 33.
 शीका *sika*, 648, 651.
 शीका *sīnka*, 648.
 शीख *sikh*, 447, 711.
 शीख *sīnk*, 447, 474, 546.
 शीठ *sith*, 848.
 शीठा *sitha*, 937, 952.
 शीड़ा *sira*, 789.
 शीड़ी *sirhi*, 429.
 शीतल *sital*, 1449.
 शीधा *sīdha*, 1272.
 शीना *sina*, 1011.
 शीपतन्नी *sipatni*, 1211.
 शीपी *sipi*, 770, 1267.
 शीम *sīm*, 1073.
 शीरक *sirak*, 731.
 शीरग *sirag*, 731.
 शीरा *sira*, 1015, 1465.
 शील *sil*, 581, 626, 1451.
 शीस *sīs*, 958, 986.
 शीसा *sīsa*, 383, 561, 958.
 शीसा धरेवाला *sīsa dharewāla*, 561.
 शुचरा *suara*, 1183.
 शुचा *sua*, 957.
 शुचा आवे है *sua āve hai*, 957.
 शुचाग्रब *suācb*, 987.
 शुचासिन *suāsin*, 1295.
 शुद्चाइल *suiāt*, 1004.
 शुद्द्या *sūya*, 957, 987.
 शुद्द्या गैल *sūya gail*, 957.
 शुदला *sūla*, 657.
 सुई *sūi*, 499, 503.
 सुकरवाँत *sukarwānt*, 1173.
 सुकल *sukl*, 1081.
 सुकल पख *sukl pakh*, 1081.
 सुकला *sukla*, 1087.
 सुख *sukh*, 1090.
 सुखठा *sukhtha*, 1074.
 सुखड़ा *sukhra*, 1074, 1458.

- सुखभामि *sukhbhāmi*, 1173.
 सुखराती *sukhrāti*, 1090, 1423.
 सुखले *sukhle*, 1088.
 सुखवन *sukhvan*, 1030.
 सुख सुख *sukh sukh*, 990.
 सुखार *sukhār*, 1077.
 सुखैनी *sukhaini*, 1458.
 सुगन्द *sugand*, 468.
 सुगन्द कोकिला *sugand kōkila*, 468.
 सुगन्द वाला *sugand wāla*, 468.
 सुगन्रा *sugra*, 789.
 सुगन्वा *sugwa*, 1000.
 सुगही *sugahi*, 411.
 सुंगार *sugār*, 1006.
 सुग्गी *suggi*, 856.
 सुजग्नी *sujni*, 637.
 सुष्ठा *sunda*, 1074.
 सुतरियाग्रल *sutariyāgral*, 1076.
 सुतरी *sutri*, 123, 243, 362.
 सुतल्ली *sutti*, 123.
 सुतग्वान *sutwān*, 503.
 सुतारी *sutāri*, 482, 589.
 सुताली *satāli*, 482.
 सुतिहार *sutihār*, 1244.
 सुतुहा *sutuha*, 319c.
 सुतेमान *sutemān*, 503.
 सुत्तिहा *suttiha*, 923.
 सुत्ती *sutti*, 922.
 सुथग्नी *suthni*, 1060.
 सुथरी *suthri*, 123.
 सुंदरी *sundri*, 1074.
 सुध *sudh*, 1289, 1486.
 सुधाबधा *sudhabadha*, 1286.
 सुधाबधा करब *sudhabadha karab*, 1286.
 सुन *sun*, 29, 1451.
 सुनु *sunu*, 1084, 1085, 1087, 1088.
 सुने *sunc*, 1486.
 सुनु *sunu*, 408, 922.
 सुन्नत *sumat*, 386, 1415.
 सुपनिया *supatiya*, 1262.
 सुपही *supahi*, 912.
 सुपारी *supāri*, 1056.
 सुपौआ *supaua*, 414.
 सुफेद *suphed*, 1016, 1138.
 सुफेद बगइहा *suphed bagchhalla*,
 1138.
 सुमकट्टी *sumkatti*, 388.
 सुमङ्गली *sumangli*, 1328.
 सुमन्तरास *sumantarās*, 388.
 सुमरणी *sumarni*, 781.
 सुमिरग्नी *sumirni*, 781.
 सुमुत *sumut*, 877.
 सुमेर *sumer*, 781.
 सुम्बा *sumba*, 582.
 सुम्बा *sumbha*, 413.
 सुम्मा *summa*, 412.
 सुम्मी *summi*, 413.
 सुम्हा *sumha*, 582.
 सुर्तग्वनियौ *surtwaniyāu*, 238.
 सुरका *surka*, 126, 1074, 1272.
 सुरका चूरा *surka chūra*, 1272.
 सुरकी *surki*, 571.
 सुरखी *surkhi*, 431, 1267.
 सुरती *surti*, 1023.
 सुरपुर *surpur*, 1025.
 सुरफा *surpha*, 1217.
 सुरफान *surphān*, 1217, 1226.
 सुरग्वरिया *surbariya*, 1183.
 सुरबार *surbār*, 1183.
 सुरमई *surmaī*, 1043.
 सुरमा *surma*, 747.
 सुरवारी *surwāri*, 1183.
 सुरवाल *surwāl*, 727, 746.
 सुरसा *sursa*, 414.
 सुराखी *surākhi*, 589.
 सुराही *surāhi*, 697, 713.
 सुरख *surakh*, 1043.
 सुरजकोइहा *surujkōihva*, 1071.
 सुरजमुखी *surajmukhi*, 1263.
 सुरैतिन *suraitin*, 1280.

- सुतन्वनियौ *surtvaniyān*, 238.
 सुलतान *sultān*, 478, 748.
 सुलतान खोदी *sultān torhi*, 748.
 सुलभ *sulabh*, 1454.
 सुलभ सुगुन *sulabh sagun*, 1454.
 सुलाखी *sulākhi*, 589.
 सुसुवा *suswa*, 545.
 सुहारी *suhāri*, 1272.
 सुहाली *suhāli*, 1378.
 सुहर *sūar*, 1125.
 सुषा *sūa*, 494, 499, 503, 589, 987.
 सुई *sūi*, 24, 589, 644, 1004, 1383.
 सुई फेंकलकैक *sūi phenkalkaik*, 1004.
 सुक *sūk*, 1008.
 सुँग *sūng*, 958, 961.
 सुगर *sūgar*, 1125.
 सुगा *sūga*, 975.
 सुगा पक्षी *sūga pankhi*, 975.
 सुँघ *sūng*, 958, 961.
 सुँज *sūj*, 494.
 सुँजी *sūji*, 1272.
 सुँद *sūur*, 958.
 सुँडा *sūura*, 1074.
 सुँडी *sūuri*, 1074.
 सुँद *sūur*, 961, 1074.
 सुँहा *sūurha*, 961.
 सुत *sūt*, 123, 238, 425, 1489.
 सुत सिखा *sut sikha*, 736.
 सुता *sūta*, 123.
 सुति *sūti*, 765.
 सुती *sūti*, 1234.
 सुते *sūte*, 572.
 सुद *sūd*, 1475, 1478, 1482.
 सुद पर रुपैया काढ़ब *sūd par rupaiya kārah*, 1478.
 सुद भरना *sūd bharna*, 1482.
 सुदी *sūdi*, 1475, 1485.
 सुदी रुपैया *sūdi rupaiya*, 1475, 1485.
 सुप *sūp*, 47, 440, 603, 604.
 सुर्त *sūrt*, 238.
 सुर *sūr*, 1087.
 सुँसा *sūnsa*, 545.
 सुँजत *sūnt*, 789.
 सुँजिया *sūjiya*, 636.
 सुँफाली *sūphāli*, 713.
 सुँदरा *sūdra*, 1236.
 सुँबारा *sūbāra*, 373.
 सुँमार *sūmār*, 319.
 सुँरङ्गा *sūraṅga*, 494.
 सुँरचा *sūraha*, 713.
 सुँरही *sūrhi*, 912, 194.
 सुँराप्रब *sūraṅb*, 1422.
 सुँवई *sūvāi*, 1272.
 सुँवटा *sūvta*, 860.
 सुँवटा *sūvta*, 860.
 सुँवन्ता *sūvnta*, 237.
 सुँवन्ती *sūvnti*, 716.
 सुँवन्तादा *sūvntāda*, 1264.
 सुँवात *sūvāt*, 835.
 सुँवार *sūvār*, 319.
 सुँवार *sūvār*, 319.
 सुँमन्नाम *sūmānā*, 1445.
 सुँना *sūnā*, 516.
 सुँनी *sūni*, 516, 539.
 सुँहोरना *sūhorna*, 319e.
 सुँ *sū*, 235, 1026, 1485.
 सुँ *sū*, 414, 867, 1183.
 सुँकी *sūki*, 1317.
 सुँथन *sūthan*, 53, 55.
 सुँहा *sūha*, 966g.
 सुँही *sūhi*, 1183.
 सुँदुर *sūdur*, 747.
 सुँनी *sūni*, 467, 711.
 सुँनुर *sūnur*, 747, 1308, 1324, 1385,
 • 1435, 1483.
 सुँनुर दान *sūnur dān*, 1331.
 सुँब *sūb*, 26.
 सुँम *sūm*, 1073
 सुँमल *sūmal*, 194.
 सुँमा *sūma*, 1073

- सेर *ser*, 1502, 1503.
 सेरङ्ग *serang*, 494.
 सेरी *seri*, 906, 1198.
 सेरी नौसत्ता *seri nausatta*, 906.
 सेल *sel*, 109.
 सेली *seli*, 109.
 सेल्ह *selh*, 1119.
 सेल्हल *selhal*, 1119.
 सेल्हा *selha*, 975, 976, 977, 978.
 सेल्ही *selhi*, 1119.
 सेव *seo*, 26, 1272.
 सेवर *sewar*, 1264.
 सेकण्डा *saikra*, 1479.
 सेनार *sainār*, 949.
 सेरन्वाह *sairvāh*, 949.
 सेरे *saiṛē*, 1274.
 सेक *saik*, 305.
 सेका *saika*, 305.
 सेँडा *saindha*, 1272.
 सेन *sain*, 711, 949.
 सेन बराप्रब *sain barāḅ*, 949.
 सेयद *saiyad*, 763.
 सेयन *saiyan*, 1073, 1183.
 सेर *sair*, 949.
 सेर (चाँड़ or दोस) चलाप्रब *sair (chāṁr or dhos) chalāḅ*, 949.
 सेरा *saira*, 48.
 सेला *saila*, 15, 236, 938.
 सोइरी *soiri*, 1398, 1402.
 सोइरी लिपाइ *soiri lipāi*, 1402.
 सोइया *soiya*, 923.
 सोकन्ना *sokna*, 965.
 सोगिला *sogila*, 661.
 सोजनी *sojni*, 637.
 सोमौषा *sojhaua*, 828.
 सोमौषा जोन *sojhaua jot*, 828.
 सोठौरा *sothaura*, 1399.
 सोठौरा *sothaura*, 1399.
 सोतन्ही *sothi*, 923.
 सोन *son*, 1047.
 सोनग्हुषा *songarhua*, 514.
 सोनग्हुषा सोनार *songarhua son*
 514.
 सोनङ्गला *sonahula*, 1043.
 सोनार *sonār*, 514, 914.
 सोनारी *sonāri*, Appendix, 14.
 सोपारी *sopāri*, 1056.
 सोबरन्ना *sobarna*, 688, 1456.
 सोबन्ना *sobra*, 965o.
 सोमन्नी *somni*, 1125.
 सोमन्ना *somra*, 819.
 सोमाता *somāta*, 839.
 सोरन्हा *sorha*, 882.
 सोरन्ही *sorhi*, 882, 883, 885, 95.
 सोरारी *sorāri*, 1400.
 सोराही *sorāhi*, 697, 711, 713, 7.
 सोलकन्ह *solkanh*, 1217.
 सोहज्जन *sohjan*, 1073.
 सोहथी *sohthi*, 852.
 सोहन्ना *sohna*, 516.
 सोहन्नी *sohni*, 516, 867.
 सोहरन्ना *soharna*, 319e.
 सोहाइ *sohāi*, 869.
 सोहाग *sohāg*, 1381, 1384.
 सोहाग के अतर *sohag ke atar*, 15.
 सोहाग पुरा *sohāg pūra*, 1381,
 सोहाग *sohāga*, 553, 1383.
 सोहागिन *sohāgin*, 1277, 1378.
 सोहागिनि *sohāgini*, 1369, 1383.
 सोहारी *sohāri*, 1272.
 सोहिजन *sohijan*, 1073.
 सोषा *soa*, 922.
 सोइ *soi*, 922.
 सोएर *soer*, 1398, 1413.
 सोएर लिपाइ *soer lipāi*, 1413.
 सोक *sok*, 639.
 सोकन *sokan*, 1134.
 सोखा *sokha*, 1453.
 सोग *sog*, 639.
 सोटा *sota*, 654.

सॉटा *sonṭā*, 103, 377, 390, 654.
 सॉठ *south*, 184.
 सोत *soṭ*, 922.
 सोना *sota*, 237, 922.
 सोतिन *soṭin*, 1276.
 सोन *son*, 1272.
 सोना *sona*, 753, 1090, 1173.
 सोना होला *sona hola*, 1173.
 सोनी *soni*, 514.
 सोने *sonē*, 1383.
 सोरा *sora*, 370; Appendix, 14.
 सोहन *sohan*, 403, 591.
 सोहब *sohab*, 867.
 सोहन *sohen*, 403.
 सोदागरी *saudāgri*, 1488.
 सोदागरी के मास *saudāgri ke māl*,
 1488.
 सो *sau*, 823.

सौंगी *saungi*, 208, 212, 213, 224.
 सौंगी के नारी *saungi ke nāri*, 224.
 सौंगी गारी *saungi gāri*, 148.
 सौन *saut*, 765.
 सौनिन *sautin*, 765, 1276.
 सौथी *sauthi*, 716.
 सौंदर *saundar*, 1263.
 सौफ *saumph*, 1073.
 सौफ़ी *saumphī*, 373.
 सौर *saur*, 1398.
 सौर निपार *saur nipāi*, 1402.
 सौरा *saunra*, 1134.
 सौरी *sauri*, 1398, 1409.
 सौसन *sausan*, 585.
 सौसन के टट्टी *sausan ke tatti*, 585.
 साती *swāti*, 1084, 1090.
 सामी *swāmi*, 1274.
 सौच *srautra*, 1356.

॥ ह ॥

हः *ha*, 1116, 1275.
 हँकवा *hankwa*, 294, 942.
 हँकनिहार *hanknihār*, 942.
 हकमेती *hakmaili*, 1201.
 हकाक *hakkāk*, 538.
 हजाम *hajām*, 383, 1326.
 हजार *hajār*, 585.
 हजार बीन *hajār bin*, 585.
 हजुरिया *hajuriya*, 733.
 हटका *hatka*, 1256.
 हटवई *hatvāi*, 914.
 हटवा *hatwa*, 914.
 हटवार *hatwāi*, 914.
 हटवे *hatve*, 914.
 हठा *hattha*, 838, 841.
 हठा बरद *hattha barad*, 841.
 हठीला *hathīla*, 1456.
 हड्डा *hudda*, 1074, 1075, 1183.
 हड्डी *huddi*, 984.

हङ्का *harka*, 68.
 हङ्गर *harwar*, 812.
 हङ्गवाय *hanrcwāy*, 131.
 हङ्गडा *harhava*, 956.
 हङ्गहा *harha*, 956.
 हडा *hara*, 1183.
 हडिडा *hariva*, 726.
 हँडिया *hanriya*, 69, 83, 139, 368,
 432, 465, 713.
 हँडोलवा *hanrolwa*, 268.
 हँडोला *hanrola*, 713.
 हडौडौ *harauri*, 844.
 हतेयरवा *hateyarwa*, 1177.
 हाडा *handā*, 251, 268, 669.
 हाथा *hemdha*, 268.
 हाथा *hattha*, 64, 307, 363, 416, 510,
 597, 915, 1129.
 हाथा चरक *hattha charak*, 597.
 हाथी *hatthi*, 510, 613.

- हथू *hatthu*, 510.
 हथ *hath*, 564.
 हथ अकुरी *hath akuri*, 564.
 थ उकुरी *hath ukri*, 564.
 हथकड़ *hathkar*, 335g.
 हथकड़ा *hathkara*, 335g.
 हथकर *hathkar*, 335g.
 हथकरा *hathkara*, 416.
 हथकल *hathkal*, 416.
 हथकुट्टा *hathkutta*, 431.
 हथगर *hathgar*, 335g.
 हथघिसेठ *hathghiset*, 801.
 हथड़ा *hathra*, 443, 621.
 हथनी *hathni*, 1129.
 हथपानी *hathpāni*, 579.
 हथफेर *hathpher*, 1476.
 हथबरन्ही *hathbarhi*, 116, 930.
 हथबै *hathbai*, 1183.
 हथरा *hathra*, 335g, 416, 443, 621.
 हथवानी *hathwāni*, 579.
 हथवासा *hathwāsa*, 185.
 हथवाँसा *hathwānsa*, 223.
 हथवाँसा *hathwāsa*, 915.
 हथहर *hathhar*, 335g, 688.
 हथा *hatha*, 64, 307, 335g, 363, 490.
 हथिनी *hathini*, 1129.
 हथिया *hathiya*, 1074, 1082, 1089.
 हथिया सुण्डा *hathiya sunda*, 1074.
 हथुनी *hathuni*, 1005.
 हथैला *hathaila*, 284.
 हथौसा *hathaua*, 831.
 हथौड़ा *hathaura*, 523.
 हथौना *hathauana*, 378, 713.
 हथौर *hathaur*, 410.
 हथौरा *hathaura*, 397, 410, 523, 552.
 हथौरी *hathauri*, 397, 512, 539, 560,
 410, 589, 552, 624.
 हनुआ *hanua*, 1173.
 हन्य उषार *hanth udhār*, 1476.
 हन्ना *hanua*, 409.
 हफनी *haphni*, 1181.
 हब-साप्रल *habsāul*, 957.
 हनेली *habeli*, 1234, 1254, 1275.
 हम *ham*, 1087, 1092.
 हमचा *hamcha*, 978.
 हमार *hamar*, 859.
 हमार बिहनाद मारल गेल *hamar bihu māral gel*, 859.
 हमहूँ *hamhūñ*, 1084.
 हमाम *hamām*, 706.
 हमाम दिशा *hamām dista*, 706.
 हमार *hamār*, 1116.
 हम्मर *hammar*, 864.
 हम्मर बनुसार भेल *hammar banus bhel*, 864.
 हर्कति *harkati*, 363.
 हर *har*, 1, 6, 328, 817, 846, 100
 1087.
 हरका *harka*, 68.
 हरकाह *harkāh*, 1098.
 हरकाहा *harkāha*, 1098.
 हरखी *harkhi*, 867.
 हरखुगानी *harkhugāni*, 840.
 हरखुली *harkhuli*, 840.
 हरखुजल *harkhūjal*, 840.
 हरखोलानी *harkholāni*, 840.
 हरखोलिया *harkholiya*, 840.
 हरखोली *harkholi*, 840.
 हर चलाप्रब *har chalaēb*, 817.
 हर चाँड़ी *har chāñri*, 24.
 हरजा *harja*, 1488.
 हरजिन्सा *harjinsa*, 806.
 हरजोषार *harjoār*, 840.
 हर जोतब *har jotab*, 817.
 हरकुटाब *harchhutāo*, 840.
 हरकुट्टन *harchhuttan*, 840.
 हरदा *harda*, 1074.
 हरदी *hardi*, 1073, 1308, 14
 1409.
 हरदी गूड़ *hardi gūr*, 1404, 1409

- हरन्दी चढ़ाप्रब *hardi charhāeb*, 1308, 1311.
 हरन्ना *harna*, 956.
 हर नाधब *har nādhab*, 817.
 हर नाधा *har nādha*, 17.
 हर पङ्गटा *har pahta*, 846.
 हरन्फोरन्वा *harphorwa*, 959.
 हरन्फोरन्वा केराव *harphorwa kerāo*, 959.
 हर बहब *har bahab*, 817.
 हरन्बिनार *harbindar*, 840.
 हर भङ्गा *harbhanga*, 846.
 हरन्महन्तर *harmahantar*, 839.
 हरन्महन्तर *harmahantar*, 839.
 हरन्महूर्तर *harmahūrat*, 1433.
 हरन्मोहन्तर *harmohtar*, 839.
 हरन्मोतर *harmotar*, 1433.
 हरन्महन्वा *harmāhwa*, 956.
 हरन्रा *harra*, 996.
 हर लथी *har ladhi*, 17.
 हरन्वत *harvat*, 839.
 हरन्वर *harvar*, 1186.
 हरन्वा *harwa*, 765.
 हरन्वाह *harwāh*, 842, 1184.
 हरन्वाहा *harwāha*, 842.
 हरन्वाही *harwāhi*, 838, 842, 1186.
 हरन्वाँही *harwāñhi*, 838.
 हर सज्जा *har sajjha*, 846.
 हर समत *har samat*, 839.
 हर समौष *har samauṣṭh*, 818, 839.
 हरन्सा *harsa*, 178, 274.
 हर सँग *har sānga*, 3.
 हरन्सोधन *harsodhan*, 1434.
 हरन्हरा *harhara*, 758.
 हर्रा *harāi*, 835, 843, 1201.
 हर्राठा *harāṭha*, 838.
 हर्राथी *harāṭhi*, 1096.
 हर्राम *harām*, 1125.
 हर्राही *harāhi*, 1201.
 हरि *hari*, 414.
 हरिश्चर *harishar*, 996.
 हरिबन्ध *haribans*, 1451.
 हरिराम बरन्म *harirām barn*, 1456.
 हरिघार *harighār*, 197.
 हरिस *haris*, 5, 1308, 1349.
 हरिसा *harisa*, 275.
 हरिहर *harihar*, 1201.
 हरिहर नाथ *harihar nāth*, 1456.
 हरिहरा *harihara*, 1201.
 हरिहरी *harihari*, 1201.
 हरिहा *hariha*, 1156.
 हरी *hari*, 1201.
 हरीस *haris*, 5.
 हरेया *hareya*, 841.
 हरेया बैल *hareya bail*, 841.
 हरेठा *haretha*, 994.
 हरौती *harauti*, 1183.
 हरौर *haraur*, 1186.
 हरौरी *harauri*, 842, 1186.
 हल *hal*, 1.
 हलङ्का *halka*, 784.
 हलङ्खा *halakha*, 385.
 हलन्दी *haldi*, 1073.
 हलन्मचानी *holmachāni*, 233.
 हलन्वाद् *halwāi*, 454.
 हलन्हलाद्कै *halhalāichhai*, 987.
 हलन्ही *halhi*, 801.
 हलाली *halāli*, 1139.
 हलुआ *halua*, 1272.
 हलुआद् *haluāi*, 296, 454, 463.
 हलुक *haluk*, 799, 800.
 हवाद् *hawāi*, 585.
 हवेली *haweli*, 1234.
 हश्टगना *hashtagna*, 451.
 हसर *hasar*, 1451.
 हसर करब *hasar karab*, 1451.
 हँसुआ *hansua*, 73, 328, 377.
 हँसुली *hansuli*, 74, 377, 765, 1439.

- हल *hast*, 1082, 1085.
 हस्ती *hasti*, 568.
 हस्तबूदी *hastbūdi*, 1222.
 हाँ *hān*, 1085.
 हाऊ *hāü*, 1458.
 हाँकब *hānkab*, 870.
 हाकिम *hākim*, 1184.
 हाकिम डकन्मी *hākim hukmi*, 1184.
 हाकिमी *hākimi*, 1470.
 हाकिमी हिस्सा *hākimi hissa*, 1470.
 हाँकी *hānki*, 870.
 हाँको *hānko*, 1087.
 हाँगी *hāngi*, 607.
 हाट *hāt*, 1070.
 हाड़ा *hāra*, 956, 1183.
 हाँड़ा *hānra*, 268.
 हाड़िन *hārin*, 1197.
 हाड़ी *hāri*, 1197.
 हाँड़ी *hānri*, 69, 139, 430, 432,
 506, 713.
 हाँड़ा *hānrha*, 669.
 हाता *hāta*, 832, 1234.
 हाता वाला *hāta wāla*, 832.
 हातुल *hātul*, 416.
 हाथ *hāth*, 356, 655, 1490.
 हाँथ *hānth*, 867, 1451, 1490.
 हाथक *hāthak*, 1070.
 हाँथकल *hānthkal*, 4116.
 हाथड़ *hāthar*, 621.
 हाथर *hāthar*, 443.
 हाँथसेँ निकारब *hānth señ nikārb*, 867.
 हाथी *hāthi*, 1084, 1129.
 हाथे *hāthe*, 478.
 हाँफ *hāmph*, 1181.
 हाबस *hābus*, 990, 1272.
 हाँमर *hāmmar*, 487.
 हार *hār*, 233, 765, 1391.
 हारवाला *hārwāla*, 1156.
 हाल *hāl*, 163, 222, 802, 827,
 964, 1215, 1223.
 हाल उपारजित *hāl upārjit*, 1215.
 हाल हासिली *hāl hāsili*, 1223.
 हावन *hāwan*,
 हावन दस्ता *hāwan dasta*, 706.
 हाशो *hāsho*, 1465.
 हाशिल *shāil*, 1076, 1077.
 हासिली *hāsili*, 1223.
 हाँसु *hānsu*, 328.
 हिक्का *hikka*, 302.
 हिंगोरी *hīngori*, 662.
 हिच्चा *hichchha*, 447.
 हितुथाना *hinūthāna*, 1064.
 हिजा *hiya*, 1070.
 हिराबोल *hirāöl*, 851.
 हिरात *hirāt*, 1153.
 हिराँत *hirānt*, 1148.
 हिसाब *hisāb*, 1468a, 1470, 1472.
 हिसाब बिकरी गल्ला *hisāb bi
 gulla*, 1468a, 1470, 147.
 Appendix, 7.
 हिस्सा *hissa*, 1214, 1470; Appe
 dix, 14.
 हिस्सा खास *hissa khās*, Appendix,
 हिस्सा पटिदारी *hissa patidāri*, 121
 हिस्सेदार *hissedār*, 1208, 1214.
 ही *hi*, 1446.
 हीँक *hīnk*, 302.
 हीन *hīn*, 1084.
 डकन्मी *hukmi*, 1184.
 डकुमत *hukumat*, 1201.
 डका *hukka*, 472, 1026, 1452.
 डका (or डका तामाकु) बन्द करब *hu
 (or hukka tamāku) band ka
 1452.*
 डजनाना *hujtāna*, 1198.
 डँडियाना *hundiyāna*, 1474.
 डँडियावन *hundiyāwan*, 1474.
 डण्डा *hunda*, 903, 1221, 1483.
 डण्डा भारा *hunda bhāra*, 1483.
 डण्डी *hundi*, 1474, 1487.

छषी पत्री *hundi patri*, 1487.
 छत्ता *huttha*, 653.
 छमन्ना *humna*, 12.
 छभेल *humel*, 765.
 छम्मा *humma*, 1458.
 छरन्का *hurka*, 1250.
 छर पटेल *hur petal*, 1098.
 छरन्ना *hurra*, 653.
 छरन्ना *hursa*, 778.
 छलुक *huluk*, 585.
 छसुनन्दान *husundān*, 711.
 हूर *hūr*, 29, 89, 471.
 हूरा *hūra*, 29, 653, 848, 868.
 हूल *hāl*, 748.
 हंगदहठ *hengaḥa*, 829.
 हंगहौ *hengahi*, 33, 118.
 हंगप्रब *hengāḥb*, 830.
 हंगती *hengti*, 808, 1016, 1019.
 हंगा *henga*, 30, 36, 830.
 हंगा चलाप्रब *henga chalāḥb*, 830.
 हंगी *hengi*, 31.
 हेड़ *her*, 1124.
 हेर *her*, 1113.
 हेरा *hera*, 1132.
 हेरा जाप्रब *hera jāḥb*, 1132.
 है *hai*, 655, 957, 964, 987, 1001,
 1004.

है *hain*, 568.
 हैकल *haikal*, 765.
 हैलक *hailak*, 765.
 होरन्ना *hōrsa*, 778.
 होरन्ना *horha*, 877, 957, 984, 990,
 1272.
 होलन्ना *holha*, 877, 957, 990.
 होँहि *hōñhi*, 1087.
 हो *ho*, 1156.
 होप्रत *hoḥt*, 363.
 होप्रब *hoḥb*, 1158.
 होप्र ला *hoḥ la*, 851.
 होए *ho*, 1088.
 होखे *hokhe*, 965, 1090.
 हो गैल *ho gail*, 1485.
 होत *hot*, 1080.
 होबौ *hobōi*, 1092.
 होम *hom*, 1332.
 होय *hoy*, 548.
 होला *hola*, 1088, 1173.
 होली *holi*, 1198.
 होली खलार *holi khetār*, 1198.
 हौदरी *hauḍri*, 323.
 हौज *hauj*, 321.
 हौद *hauḍ*, 316, 321.
 हौदी *hauḍi*, 314.

